

Tonellidesign

2026 / EU / Listino Prezzi / Price List

Listino Prezzi 2026

CONDIZIONI DI VENDITA PER L'ITALIA

Prezzi al pubblico I.V.A. esclusa

Le seguenti condizioni di vendita vengono accettate dall'acquirente con il conferimento dell'ordine.

Accettazione dell'ordine

L'ordine di acquisto dei prodotti del presente listino è subordinato all'approvazione e all'accettazione da parte di Tonelli Design

Ordini

Tutti gli ordini vengono confermati da Tonelli Design. Si raccomanda un attento controllo della conferma da parte del Cliente e l'immediata segnalazione di eventuali errori.

Preventivi

L'ordine viene disegnato da Tonelli Design e trasmesso al Cliente. Per confermare il preventivo il Cliente deve restituire il disegno apponendo timbro e firma per accettazione e conferma.

Prezzi

I valori sono espressi in Euro.

L'azienda si riserva la facoltà di variare il listino prezzi senza preavviso. Il presente listino prezzi annulla e sostituisce tutti i precedenti.

Annullamento e modifica dell'ordine

Tonelli Design si riserva la facoltà di rifiutare l'annullamento di un ordine dopo il ricevimento della conferma dell'ordine. Per gli articoli prodotti sarà addebitato il 100% del prezzo concordato della merce annullata o modificata. Per quelli in corso di produzione, un costo comunque non inferiore al 50% del prezzo di listino della merce.

Data di spedizione

La data di spedizione indicata sulla nostra conferma d'ordine ha valore semplicemente indicativo. Cause di forza maggiore possono a volte impedirvi di rispettare le scadenze indicate. L'eventuale ritardo di consegna non potrà per nessun motivo dare adito all'annullamento totale o parziale dell'ordine, né ad azioni di rivalsa e/o risarcimento nei confronti di Tonelli Design.

Trasporti

La merce viene consegnata esclusivamente presso la sede del rivenditore **per ordini di importo netto superiore a euro 1.000,00.**

Per ordini di valore inferiore sarà addebitata una compartecipazione trasporto di euro 80,00.

La merce viaggia a mezzo corriere, al ricevimento si raccomanda un attento controllo dei colli e del loro numero.

Reclami

Dovranno essere segnalati per iscritto da parte del Cliente entro 7 giorni dal ricevimento della merce.

E' indispensabile: apporre riserva scritta sulla bolla di accompagnamento (sia sulla copia del vettore sia su quella del destinatario). La riserva scritta dovrà essere dettagliata indicando specificatamente la motivazione, ai fine di una corretta evasione della pratica di reclamo, non è sufficiente la sola riserva generica.

Inviare una mail con il seguente materiale:

- 1) foto chiara della parte danneggiata o non conforme;**
- 2) numero ddt e descrizione dettagliata del reclamo**

La merce difettosa verrà riparata o sostituita ad insindacabile giudizio dell'Azienda. E' escluso qualsiasi indennizzo per danni e spese collegati al reclamo.

Resi

Non si accettano resi se non preventivamente autorizzati.

Pagamenti

Le modalità di pagamento sono indicate nella conferma d'ordine. La non osservanza dei termini di pagamento comporta l'addebito degli interessi di mora. Eventuali inadempienze nei pagamenti autorizzano l'Azienda a sospendere la produzione della merce in ordine e a richiedere il saldo anticipato per le forniture in corso e future. L'Azienda si riserva il diritto di proprietà sulla merce fino all'avvenuto pagamento integrale della fornitura.

Tolleranze

Le misure indicate sul presente listino possono subire lievi modifiche dovute a problemi produttivi.

Colori

I colori del campionario sono indicativi. Confermando un ordine il Cliente accetta le eventuali tolleranze di colori e finiture.

Foro competente

Le controversie aventi origine dalle forniture saranno di competenza esclusiva del Foro di Pesaro.

Price List 2026

SALES CONDITIONS (OTHER COUNTRIES)

Public prices, VAT duties and taxes not included

The following sales conditions are automatically accepted by the customer sending the order.

Order acceptance

The order of the goods in this price list is subject to the approval and acceptance by Tonelli design.

Orders

All orders must be confirmed by Tonelli design. Please carefully check the order confirmation and advise immediately about possible mistakes.

Offers

Drawings of the goods ordered are designed by Tonelli design and sent to customer. To confirm the offer, the customer must send back the drawing duly signed as approved and confirmed.

Prices

Values are in Euro.

Tonelli design reserves the right to change the price list without any previous notice. This price list cancels and replaces all previous ones.

Order cancellation and modification

Tonelli design can refuse to cancel an order after the receipt of the order confirmation. For goods already produced Tonelli design will charge 100% of the order value. For goods not yet finished but in production a charge not lower than 50% of the agreed upon price will be charged.

Shipment date

The shipment dates indicated in our order confirmations are approximate and not binding. Force majeure may prevent us from complying with the indicated deadlines. Possible delays in shipment can under no circumstances give cause to total or partial cancelation of the order, nor to any request of compensation from Tonelli design.

Transport

Please refer to the conditions agreed for your local area.

Claims

Possible claims must be transmitted by customer within 7 days from delivery of goods. It is essential to: expressly formulate a written reserve on the packing list or delivery note (both on shipper's and recipient's copy). The reserve shall be written in detail with a specific explanation, so as to allow a correct processing of the claim. Send an e-mail with the following material:

- 1) clear picture of the damaged or non-compliant part;**
- 2) original order n. and detailed description of the claim.**

Faulty goods will be repaired or replaced at the sole discretion of Tonelli design. Any compensation for damages and collateral costs linked to the claim are excluded.

Returns

Only the returns of goods previously authorised by Tonelli design will be accepted.

Payments

Payment terms are indicated in the order confirmation.

Any delay in payment will automatically imply the charge of interests on arrears. Moreover, Tonelli design is authorised to stop the production of goods ordered.

The goods are in any case property of Tonelli design until all payments have been received.

Tolerances

The measures indicated in the price list may be subject to slight changes due to production issues.

Colours

Sample colours are indicative. By confirming an order, the customer automatically accepts slight changes in colours and finishes.

Governing law and competent court

All sales subject to the present conditions are governed by Italian law. Any disputes originating from the supply are under the jurisdiction of the Pesaro Court in Italy.

<p>003 tavoli dining tables</p> <p>004 Bacco 005 Bakkarat 006 Bow 010 Cathedral 012 Codex 016 Crossover 018 Farniente 020 Hybrid 022 Livingstand 025 Metropolis 028 Nuvolari 032 T5 038 Thrim 042 Wiston</p>	<p>087 madie cabinet sideboards cabinets</p> <p>088 Alicante 090 Ateera 099 Ateera cabinet 100 Dimora 101 Liber 102 Luma</p>	<p>163 consolle consoles</p> <p>164 Gotham 165 Gulliver 165 Gulliver 2 166 Liber 167 Marcell 168 Metropolis 169 Penrose 169 Quiller 170 Sestante</p>
<p>049 tavoli XXL tables XXL</p> <p>050 Metropolis XXL</p>	<p>105 tavoli bassi coffee tables</p> <p>106 After9 114 Dekon 2 115 Eden 115 Fratina 2 116 Farniente 117 Kat 118 Metropolis 119 Oasis 120 Plinsky 121 Sestante</p>	<p>173 librerie bookcases</p> <p>174 Liber 180 Hemingway 194 Quiller</p>
<p>053 tavoli allungabili extending tables</p> <p>054 Livingstone 057 T5 E ceramic</p>	<p>125 fianco divano side tables</p> <p>126 Bakkarat basso 126 Il paese delle meraviglie 127 Joliet 128 Liber 130 Metropolis 131 Oasis 132 Opalina 132 Sestante 133 Soft glass side 133 Trio</p>	<p>197 vetrine showcases</p> <p>198 Broadway</p> <p>201 mobili tv tv units</p> <p>202 Comò alto Comò basso 203 WG system</p>
<p>059 tavoli da bistrot bistrot tables</p> <p>060 Farniente</p>	<p>135 specchi mirrors</p> <p>136 Bands 138 Barcode 140 Beryl 142 Central 144 Fittipaldi 146 Gerundio 150 Iris 152 Maybe 154 Mercury 155 Mydear 156 Ozma 157 Soglia 158 Split 160 Stati d'animo 161 VU</p>	<p>211 divani sofas</p> <p>212 Soft glass</p> <p>219 poltrone armchairs</p> <p>220 Naked</p>
<p>063 home office home office</p> <p>064 Logica 065 Marcell 064 Penrose</p>	<p>067 sedie chairs</p> <p>068 Aw_chair 069 Dea 070 Ekua 071 Mit 072 Sanur 073 She</p>	<p>223 comodini comò toeletta bedside tables dressers dressing tables</p> <p>224 Comò alto Comò basso 225 Liber 227 Opalina toeletta</p>
<p>076 lampade lamps</p> <p>076 Cathedral 078 Hyperion 082 Noum 084 Rook 085 Transition</p>		<p>229 carrelli trolleys</p> <p>230 Grattacielo</p>
		<p>235 vasi planters</p> <p>236 Amon 237 Lingo</p>
		<p>239 rivestimenti boiserie wall coverings boiserie</p> <p>240 Wonderwall</p>

tavoli | dining tables

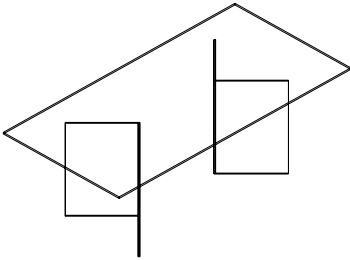
	I E D F	dimensioni dimension abmessungen dimension	spessore thickness stärke épaisseur	volume volume volumen volume	carico ammesso admitted load tragfähigkeit charge admise	peso weight gewicht poids	prezzo price preis prix
		cm	mm	m3	kg	kg	euro
Bacco design Tonelli Studio 		180 x 90 x h 73	12	0,356	150	96	<input type="checkbox"/> 1.960 <input checked="" type="checkbox"/> 2.110 <input checked="" type="checkbox"/> 2.320
		200 x 100 x h 73	12	0,369	150	110	<input type="checkbox"/> 2.280 <input checked="" type="checkbox"/> 2.440 <input checked="" type="checkbox"/> 2.690
		220 x 100 x h 73	12	0,37	150	113	<input type="checkbox"/> 2.410 <input checked="" type="checkbox"/> 2.580 <input checked="" type="checkbox"/> 2.830
		240 x 100 x h 73	12	0,390	150	116	<input type="checkbox"/> 2.520 <input checked="" type="checkbox"/> 2.700 <input checked="" type="checkbox"/> 2.970
		245 x 120 x h 73	12	0,44	150	140	<input type="checkbox"/> 2.760 <input checked="" type="checkbox"/> 2.960 <input checked="" type="checkbox"/> 3.260
		260 x 100 x h 73	12	0,45	150	150	<input type="checkbox"/> 2.680 <input checked="" type="checkbox"/> 2.870 <input checked="" type="checkbox"/> 3.160
		280 x 100 x h 73	12	0,47	150	157	<input type="checkbox"/> 3.140 <input checked="" type="checkbox"/> 3.360 <input checked="" type="checkbox"/> 3.670
		300 x 100 x h 73	12	0,49	150	165	<input type="checkbox"/> 3.290 <input checked="" type="checkbox"/> 3.520 <input checked="" type="checkbox"/> 3.870

- basamento e piano extrachiaro / extra clear base and top
Gestell und Tischplatte extrahell / piètement et top extra clair
- basamento e piano fumè / smoked base and top
Gestell und Tischplatte aus Rauchglas / piètement et top fumé
- basamento e piano bronzo / bronze base and top
Gestell und Tischplatte aus Bronze Glas / piètement et top bronze

- Tavolo con piano in appoggio in vetro extra chiaro, fumè o bronzo temperato.
 Basamento formato da due elementi accostabili in vetro extra chiaro, fumè o bronzo incollati tra loro.
 - Table with loose top in tempered extra clear, smoked or bronze glass.
 Base made of two approachable elements in extra clear, smoked or bronze glass parts glued together.
 - Tisch mit Platte aus extrahellem, Rauch oder Bronze Sicherheitsglas.
 Gestell besteht aus zwei Elementen aus zusammenverklebten extrahellem, Rauch oder Bronze Glas.
 - Table avec plateau en verre trempé extra clair, fumé ou bronze.
 Le piètement est composé de deux éléments assemblables en verre extra clair, fumé ou bronze, collés ensemble.

	I	dimensioni	spessore	volume	carico ammesso	peso	prezzo
	E	dimension	thickness	volume	admitted load	weight	price
	D	abmessungen	stärke	volumen	tragfähigkeit	gewicht	preis
	F	dimension	épaisseur	volume	charge admise	poids	prix
		cm	mm	m3	kg	kg	euro
Bakkarat alto design D'Urbino Lomazzi 2014		Ø 110 x h 75	12 / 30	0,28	120	82	3.600
		Ø 120 x h 75	12 / 30	0,30	120	87	3.700
		Ø 130 x h 75	12 / 30	0,33	120	92	3.800
		Ø 140 x h 75	12 / 30	0,36	120	97	3.900

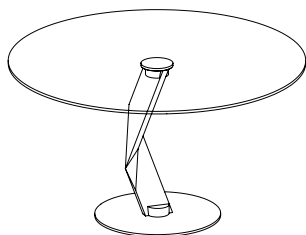

- Tavolo alto con piano in vetro temperato, gamba centrale in vetro spessore 30mm, base in metallo cromato. Disponibile solo in vetro extrachiaro.
- High table with extra clear tempered glass top, central leg in 30mm thick glass, chrome metal base. Available only in extra clear glass.
- Hoher Tisch mit extraheller Glasplatte aus Sicherheitsglas, zentraler Bein aus 30mm dickem Glas, Grundgestell aus verchromten Metall. Nur in extrahellem Glas erhältlich.
- Table haute avec plateau en verre extra clair trempé, pied central en épaisseur 30mm, base en métal chromé. Disponible seulement en verre extra clair.

	I E D F	dimensioni dimension abmessungen dimension	spessore thickness stärke épaisseur	volume volume volumen volume	carico ammesso admitted load tragfähigkeit charge admise	peso weight gewicht poids	prezzo price preis prix
		cm	mm	m3	kg	kg	euro

Bow

design Massimo Castagna 2024

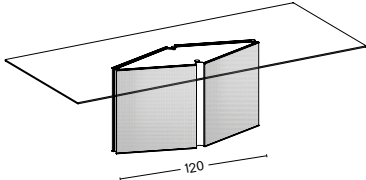
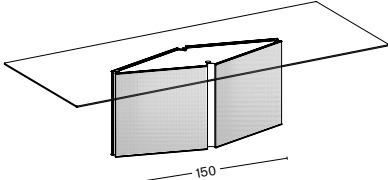
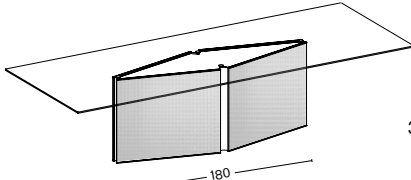
	200 x 100 x h 75	10	0,44	150	144	○ □ 4.540 ■ 4.580 ■ 4.600 ○○ □ 4.530 ■ 4.570 ■ 4.590
	220 x 100 x h 75	10	0,46	150	150	○ □ 4.640 ■ 4.680 ■ 4.700 ○○ □ 4.630 ■ 4.670 ■ 4.690
	240 x 100 x h 75	10	0,48	150	159	○ □ 4.740 ■ 4.780 ■ 4.800 ○○ □ 4.730 ■ 4.770 ■ 4.790
	260 x 100 x h 75	10	0,55	150	182	○ □ 5.520 ■ 5.560 ■ 5.580 ○○ □ 5.510 ■ 5.550 ■ 5.570
	280 x 100 x h 75	10	0,58	150	190	○ □ 5.700 ■ 5.740 ■ 5.760 ○○ □ 5.690 ■ 5.730 ■ 5.750
	300 x 100 x h 75	10 / 12	0,66	150	214	○ □ 6.370 ■ 6.410 ■ 6.430 ○○ □ 6.360 ■ 6.400 ■ 6.420
	320 x 120 x h 75	10 / 12	0,73	150	241	○ □ 6.650 ■ 6.690 ■ 6.710 ○○ □ 6.640 ■ 6.680 ■ 6.700

- Vetro extrachiaro / extra clear glass / extrahelles Glas / verre extra clair
- Vetro fumé / smoked glass / Rauchglas / verre fumé
- Vetro bronzo / bronze glass / Bronze Glas / Verre bronze

- basamento vetro fuso **T-Squares** fumé o bronzo / base fused glass **T-Squares** smoked or bronze
Gestell aus geschmolzenem Glas **T-Squares** Rauchfarbe oder Bronze / base en verre en fusion **T-Squares**, fumé ou bronze.
- basamento vetro fuso **T-Stripes** fumé o bronzo / base fused glass **T-Stripes** smoked or bronze
Gestell aus geschmolzenem Glas **T-Stripes** Rauchfarbe oder Bronze / base en verre en fusion **T-Stripes**, fumé ou bronze.

Specificare sempre la finitura del basamento, vetro fuso fumé o bronzo
Always specify base finish, smoked or bronze fused glass
Immer Ausführung des geschmolzenem Gestell angeben, Rauchfarbe oder Bronze
Spécifier toujours finition du piètement en verre en fusion , fumé ou bronze

- Tavolo con basamento centrale in vetro fuso, nelle varianti T-Squares e T-Stripes, finitura fumé o bronzo.
Elementi strutturali del basamento in metallo nero opaco.
Top di vetro fissati con piastre saldate, possono avere la forma rettangolare, sagomata o ovale, finiture extra chiaro, fumé o bronzo.
- Table with central base in fused glass, in versions T-Squares and T-Stripes, finish smoked or bronze.
Structural base elements in matt black metal.
Glass tops, fixed with welded plates, can be rectangular, shaped or oval, finishes can be extra clear, smoked or bronze.
- Tisch mit zentralem Gestell aus geschmolzenem Glas in Version T-Squares und T-Stripes, Ausführung Rauchfarbe oder Bronze.
Strukturelemente des Gestells aus Metall matt schwarz.
Tischplatte aus Glas, befestigt mit geschweißten Metallplatten, kann rechteckig, profiliert oder oval sein, Ausführung in extrahell, Rauchfarbe oder Bronze.
- Table avec base central en verre en fusion dans les versions T-Squares et T-Stripes, finition fumé ou bronze.
Éléments structurels de la base en métal noir mat.
Top en verre, fixé avec plaques soudé, peut être en version rectangulaire, profilé ou ovale, en finition extra clair, fumé ou bronze.

	I E D F	dimensioni dimension abmessungen dimension	spessore thickness stärke épaisseur	volume volume volumen volume	carico ammesso admitted load tragfähigkeit charge admise	peso weight gewicht poids	prezzo price preis prix
		cm	mm	m3	kg	kg	euro

Bow

design Massimo Castagna 2024

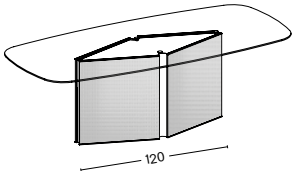
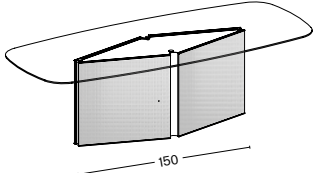
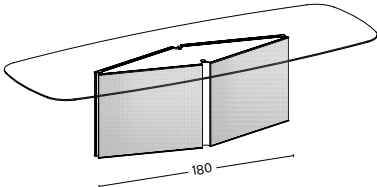
	200 x 110 x h 75	10	0,46	150	145	<input type="checkbox"/> 4.620 <input checked="" type="checkbox"/> 4.660 <input checked="" type="checkbox"/> 4.680 <input type="radio"/> 4.610 <input checked="" type="radio"/> 4.650 <input checked="" type="radio"/> 4.670
	220 x 110 x h 75	10	0,48	150	152	<input type="checkbox"/> 4.720 <input checked="" type="checkbox"/> 4.760 <input checked="" type="checkbox"/> 4.780 <input type="radio"/> 4.710 <input checked="" type="radio"/> 4.750 <input checked="" type="radio"/> 4.770
	240 x 110 x h 75	10	0,50	150	160	<input type="checkbox"/> 4.820 <input checked="" type="checkbox"/> 4.860 <input checked="" type="checkbox"/> 4.880 <input type="radio"/> 4.810 <input checked="" type="radio"/> 4.850 <input checked="" type="radio"/> 4.870
	260 x 110 x h 75	10	0,58	150	183	<input type="checkbox"/> 5.600 <input checked="" type="checkbox"/> 5.640 <input checked="" type="checkbox"/> 5.660 <input type="radio"/> 5.590 <input checked="" type="radio"/> 5.630 <input checked="" type="radio"/> 5.650
	280 x 110 x h 75	10	0,60	150	191	<input type="checkbox"/> 5.780 <input checked="" type="checkbox"/> 5.820 <input checked="" type="checkbox"/> 5.840 <input type="radio"/> 5.770 <input checked="" type="radio"/> 5.810 <input checked="" type="radio"/> 5.830
	300 x 120 x h 75	10 / 12	0,69	150	215	<input type="checkbox"/> 6.440 <input checked="" type="checkbox"/> 6.490 <input checked="" type="checkbox"/> 6.510 <input type="radio"/> 6.430 <input checked="" type="radio"/> 6.480 <input checked="" type="radio"/> 6.500
	320 x 120 x h 75	10 / 12	0,75	150	233	<input type="checkbox"/> 6.730 <input checked="" type="checkbox"/> 6.770 <input checked="" type="checkbox"/> 6.790 <input type="radio"/> 6.720 <input checked="" type="radio"/> 6.760 <input checked="" type="radio"/> 6.780

- Vetro extrachiaro / extra clear glass / extrahelles Glas / verre extra clair
- Vetro fumé / smoked glass / Rauchglas / verre fumé
- Vetro bronzo / bronze glass / Bronze Glas / Verre bronze

- basamento vetro fuso **T-Squares** fumé o bronzo / base fused glass **T-Squares** smoked or bronze
Gestell aus geschmolzenem Glas **T-Squares** Rauchfarbe oder Bronze / base en verre en fusion **T-Squares**, fumé ou bronze.
- basamento vetro fuso **T-Stripes** fumé o bronzo / base fused glass **T-Stripes** smoked or bronze
Gestell aus geschmolzenem Glas **T-Stripes** Rauchfarbe oder Bronze / base en verre en fusion **T-Stripes**, fumé ou bronze.

Specificare sempre la finitura del basamento, vetro fuso fumé o bronzo
Always specify base finish, smoked or bronze fused glass
Immer Ausführung des geschmolzenem Gestell angeben, Rauchfarbe oder Bronze
Spécifier toujours finition du piètement en verre en fusion , fumé ou bronze

- Tavolo con basamento centrale in vetro fuso, nelle varianti T-Squares e T-Stripes, finitura fumé o bronzo.
Elementi strutturali del basamento in metallo nero opaco.
Top di vetro fissati con piastre saldate, possono avere la forma rettangolare, sagomata o ovale, finiture extra chiaro, fumé o bronzo.
- Table with central base in fused glass, in versions T-Squares and T-Stripes, finish smoked or bronze.
Structural base elements in matt black metal.
Glass tops, fixed with welded plates, can be rectangular, shaped or oval, finishes can be extra clear, smoked or bronze.
- Tisch mit zentralem Gestell aus geschmolzenem Glas in Version T-Squares und T-Stripes, Ausführung Rauchfarbe oder Bronze.
Strukturelemente des Gestells aus Metall matt schwarz.
Tischplatte aus Glas, befestigt mit geschweißten Metallplatten, kann rechteckig, profiliert oder oval sein, Ausführung in extrahell, Rauchfarbe oder Bronze.
- Table avec base central en verre en fusion dans les versions T-Squares et T-Stripes, finition fumé ou bronze.
Éléments structurels de la base en métal noir mat.
Top en verre, fixé avec plaques soudé, peut être en version rectangulaire, profilé ou ovale, en finition extra clair, fumé ou bronze.

	I dimensioni	spessore	volume	carico ammesso	peso	prezzo
E	dimension	thickness	volume	admitted load	weight	price
D	abmessungen	stärke	volumen	tragfähigkeit	gewicht	preis
F	dimension	épaisseur	volume	charge admise	poids	prix
	cm	mm	m3	kg	kg	euro

Bow

design Massimo Castagna 2024

280 x 110 x h 75	10	0,60	150	179	<input type="checkbox"/> <input type="checkbox"/> 5.800 ■ 5.840 ■ 5.860 <input type="radio"/> <input type="radio"/> 5.790 ■ 5.830 ■ 5.850
------------------	----	------	-----	-----	--

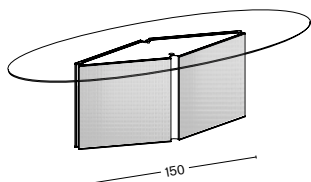

320 x 120 x h 75	10 / 12	0,73	150	217	<input type="checkbox"/> <input type="checkbox"/> 6.750 ■ 6.790 ■ 6.810 <input type="radio"/> <input type="radio"/> 6.740 ■ 6.780 ■ 6.800
------------------	---------	------	-----	-----	--

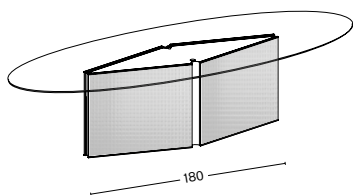

- Vetro extrachiaro / extra clear glass / extrahelles Glas / verre extra clair
 - Vetro fumé / smoked glass / Rauchglas / verre fumé
 - Vetro bronzo / bronze glass / Bronze Glas / Verre bronze
-
- basamento vetro fuso **T-Squares** fumé o bronzo / base fused glass **T-Squares** smoked or bronze
Gestell aus geschmolzenem Glas **T-Squares** Rauchfarbe oder Bronze / base en verre en fusion **T-Squares**, fumé ou bronze.
 - basamento vetro fuso **T-Stripes** fumé o bronzo / base fused glass **T-Stripes** smoked or bronze
Gestell aus geschmolzenem Glas **T-Stripes** Rauchfarbe oder Bronze / base en verre en fusion **T-Stripes**, fumé ou bronze.

Specificare sempre la finitura del basamento, vetro fuso fumé o bronzo
Always specify base finish, smoked or bronze fused glass
Immer Ausführung des geschmolzenem Gestell angeben, Rauchfarbe oder Bronze
Spécifier toujours finition du piètement en verre en fusion , fumé ou bronze

- Tavolo con basamento centrale in vetro fuso, nelle varianti T-Squares e T-Stripes, finitura fumé o bronzo.
Elementi strutturali del basamento in metallo nero opaco.
Top di vetro fissati con piastre saldate, possono avere la forma rettangolare, sagomata o ovale, finiture extra chiaro, fumé o bronzo.
- Table with central base in fused glass, in versions T-Squares and T-Stripes, finish smoked or bronze.
Structural base elements in matt black metal.
Glass tops, fixed with welded plates, can be rectangular, shaped or oval, finishes can be extra clear, smoked or bronze.
- Tisch mit zentralem Gestell aus geschmolzenem Glas in Version T-Squares und T-Stripes, Ausführung Rauchfarbe oder Bronze.
Strukturelemente des Gestells aus Metall matt schwarz.
Tischplatte aus Glas, befestigt mit geschweißten Metallplatten, kann rechteckig, profiliert oder oval sein, Ausführung in extrahell, Rauchfarbe oder Bronze.
- Table avec base central en verre en fusion dans les versions T-Squares et T-Stripes, finition fumé ou bronze.
Éléments structurels de la base en métal noir mat.
Top en verre, fixé avec plaques soudé, peut être en version rectangulaire, profilé ou ovale, en finition extra clair, fumé ou bronze.

	I	dimensioni	spessore	volume	carico ammesso	peso	prezzo
	E	dimension	thickness	volume	admitted load	weight	price
	D	abmessungen	stärke	volumen	tragfähigkeit	gewicht	preis
	F	dimension	épaisseur	volume	charge admise	poids	prix
		cm	mm	m3	kg	kg	euro

Bow Round

design Massimo Castagna 2026

Ø140 x h 75	12	0,39	150	131	<input type="checkbox"/> 4.360 <input checked="" type="checkbox"/> 4.420 <input checked="" type="checkbox"/> 4.520 <input type="radio"/> 4.350 <input checked="" type="radio"/> 4.410 <input checked="" type="radio"/> 4.510
-------------	----	------	-----	-----	---

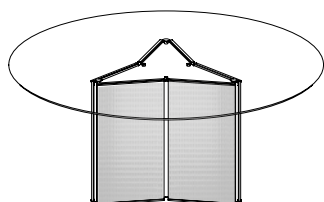

Ø160 x h 75	12	0,45	150	148	<input type="checkbox"/> 4.680 <input checked="" type="checkbox"/> 4.750 <input checked="" type="checkbox"/> 4.870 <input type="radio"/> 4.670 <input checked="" type="radio"/> 4.740 <input checked="" type="radio"/> 4.860
-------------	----	------	-----	-----	---

Ø180 x h 75	12	0,53	150	167	<input type="checkbox"/> 5.050 <input checked="" type="checkbox"/> 5.130 <input checked="" type="checkbox"/> 5.280 <input type="radio"/> 5.040 <input checked="" type="radio"/> 5.120 <input checked="" type="radio"/> 5.270
-------------	----	------	-----	-----	---

- Vetro extrachiaro / extra clear glass / extrahelles Glas / verre extra clair
 - Vetro fumé / smoked glass / Rauchglas / verre fumé
 - Vetro bronzo / bronze glass / Bronze Glas / Verre bronze
-
- basamento vetro fuso **T-Squares** fumé o bronzo / base fused glass **T-Squares** smoked or bronze
Gestell aus geschmolzenem Glas **T-Squares** Rauchfarbe oder Bronze / base en verre en fusion **T-Squares**, fumé ou bronze.
 - basamento vetro fuso **T-Stripes** fumé o bronzo / base fused glass **T-Stripes** smoked or bronze
Gestell aus geschmolzenem Glas **T-Stripes** Rauchfarbe oder Bronze / base en verre en fusion **T-Stripes**, fumé ou bronze.

Specificare sempre la finitura del basamento, vetro fuso fumé o bronzo
Always specify base finish, smoked or bronze fused glass
Immer Ausführung des geschmolzenem Gestell angeben, Rauchfarbe oder Bronze
Spécifier toujours finition du piètement en verre en fusion , fumé ou bronze

- Tavolo con basamento centrale in vetro fuso, nelle varianti T-Squares e T-Stripes, finitura fumé o bronzo.
Elementi strutturali del basamento in metallo nero opaco.
Top di vetro fissati con piastre saldate, possono avere la forma rotonda, finiture extra chiaro, fumé o bronzo.
- Table with central base in fused glass, in versions T-Squares and T-Stripes, finish smoked or bronze.
Structural base elements in matt black metal.
Glass tops, fixed with welded plates, can be round, finishes can be extra clear, smoked or bronze.
- Tisch mit zentralem Gestell aus geschmolzenem Glas in Version T-Squares und T-Stripes, Ausführung Rauchfarbe oder Bronze.
Strukturelemente des Gestells aus Metall matt schwarz.
Tischplatte aus Glas, befestigt mit geschweißten Metallplatten, kann rund sein,
Ausführung in extrahell, Rauchfarbe oder Bronze.
- Table avec base central en verre en fusion dans les versions T-Squares et T-Stripes, finition fumé ou bronze.
Éléments structurels de la base en métal noir mat.
Top en verre, fixé avec plaques soudé, peut être en version ronde, en finition extra clair, fumé ou bronze.

	I	dimensioni	spessore	volume	carico ammesso	peso	prezzo
	E	dimension	thickness	volume	admitted load	weight	price
	D	abmessungen	stärke	volumen	tragfähigkeit	gewicht	preis
	F	dimension	épaisseur	volume	charge admise	poids	prix
		cm	mm	m3	kg	kg	euro

Cathedral

design Studio 14 2026

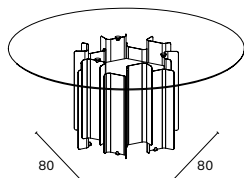

Ø160 x h 75	12	0,87	150	143	○ □ 4.040 ■ 4.190 ■ 4.200 ○○ □ 4.460 ■ 4.610 ■ 4.620 ○○○ □ 4.480 ■ 4.630 ■ 4.640
Ø180 x h 75	12	0,94	150	162	○ □ 4.470 ■ 4.660 ■ 4.670 ○○ □ 4.890 ■ 5.080 ■ 5.090 ○○○ □ 4.910 ■ 5.100 ■ 5.110
Ø200 x h 75	12	1,02	150	184	○ □ 4.980 ■ 5.210 ■ 5.220 ○○ □ 5.400 ■ 5.630 ■ 5.640 ○○○ □ 5.420 ■ 5.650 ■ 5.660

- Vetro extrachiaro / extra clear glass / extrahelles Glas / verre extra clair
- Vetro fumé / smoked glass / Rauchglas / verre fumé
- Vetro bronzo / bronze glass / Bronze Glas / Verre bronze

- basamento **nero grafite** / base **graphite black** / Gestell **Grafitschwarz** / piètement **noir graphite**
- basamento **Dark Brown** / base **Dark Brown** / Gestell **Dark Brown** / piètement **Dark Brown**
- basamento **Champagne, Bronzo, Titanio o Red Jaipur** / base **Champagne, Bronzo, Titanio or Red Jaipur** / Gestell **Champagnerfarbe, Bronzo, Titanio oder Red Jaipur** / piètement **Champagne, Bronzo, Titanio ou Red Jaipur**

**Specificare sempre la finitura del basamento verniciato / always specify finish of lacquered base
immer Ausführung des lackierten Gestells angeben / spécifier toujours finition du piètement laqué.**

- Tavolo con basamento centrale in metallo. Finiture: Bronzo, Titanio, Champagne, Dark Brown, Red Jaipur e verniciato nero grafite.
Top in appoggio rotondi in vetro extrachiaro, fumé o bronzo.
Table with central base in metal. Finishes: Bronzo, Titanio, Champagne, Dark Brown, Red Jaipur and graphite black lacquered.
- Round tops in extra clear, smoked or bronze glass.
Tisch mit zentralem Gestell aus Metall. Ausführungen: Bronzo, Titanio, Champagne, Dark Brown, Red Jaipur und Grafitschwarz lackiert.
Aufsitztop rund aus extrahellem, Rauch oder Bronze Glas.
- Table avec base central en métal. Finitions: Bronzo, Titanio, Champagne, Dark Brown, Red Jaipur et lacqué noir graphite.
Plateaux en version ronde en verre extra clair, fumé ou bronze.

	I	dimensioni	spessore	volume	carico ammesso	peso	prezzo
	E	dimension	thickness	volume	admitted load	weight	price
	D	abmessungen	stärke	volumen	tragfähigkeit	gewicht	preis
	F	dimension	épaisseur	volume	charge admise	poids	prix
		cm	mm	m3	kg	kg	euro

Cathedral

design Studio 14 2026

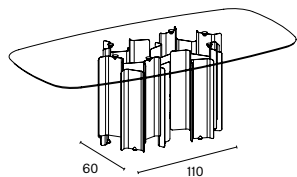

200 x 110 x h 75	10	0,96	150	136	<input type="checkbox"/> 4.390 <input checked="" type="checkbox"/> 4.520 <input checked="" type="checkbox"/> 4.530 <input type="checkbox"/> 4.500 <input checked="" type="checkbox"/> 4.630 <input checked="" type="checkbox"/> 4.640 <input type="checkbox"/> 4.520 <input checked="" type="checkbox"/> 4.650 <input checked="" type="checkbox"/> 4.660
220 x 110 x h 75	10	0,98	150	143	<input type="checkbox"/> 4.470 <input checked="" type="checkbox"/> 4.600 <input checked="" type="checkbox"/> 4.610 <input type="checkbox"/> 4.580 <input checked="" type="checkbox"/> 4.710 <input checked="" type="checkbox"/> 4.720 <input type="checkbox"/> 4.600 <input checked="" type="checkbox"/> 4.730 <input checked="" type="checkbox"/> 4.740
240 x 110 x h 75	10	1,00	150	151	<input type="checkbox"/> 4.680 <input checked="" type="checkbox"/> 4.820 <input checked="" type="checkbox"/> 4.830 <input type="checkbox"/> 4.800 <input checked="" type="checkbox"/> 4.940 <input checked="" type="checkbox"/> 4.950 <input type="checkbox"/> 4.820 <input checked="" type="checkbox"/> 4.960 <input checked="" type="checkbox"/> 4.970
260 x 110 x h 75	10	1,21	150	182	<input type="checkbox"/> 5.230 <input checked="" type="checkbox"/> 5.380 <input checked="" type="checkbox"/> 5.390 <input type="checkbox"/> 5.350 <input checked="" type="checkbox"/> 5.500 <input checked="" type="checkbox"/> 5.510 <input type="checkbox"/> 5.370 <input checked="" type="checkbox"/> 5.520 <input checked="" type="checkbox"/> 5.530
280 x 110 x h 75	10	1,23	150	189	<input type="checkbox"/> 5.740 <input checked="" type="checkbox"/> 5.900 <input checked="" type="checkbox"/> 5.910 <input type="checkbox"/> 5.860 <input checked="" type="checkbox"/> 6.020 <input checked="" type="checkbox"/> 6.030 <input type="checkbox"/> 5.880 <input checked="" type="checkbox"/> 6.040 <input checked="" type="checkbox"/> 6.050
300 x 120 x h 75	12	1,29	150	204	<input type="checkbox"/> 6.870 <input checked="" type="checkbox"/> 7.040 <input checked="" type="checkbox"/> 7.050 <input type="checkbox"/> 7.240 <input checked="" type="checkbox"/> 7.410 <input checked="" type="checkbox"/> 7.420 <input type="checkbox"/> 7.260 <input checked="" type="checkbox"/> 7.430 <input checked="" type="checkbox"/> 7.440
320 x 120 x h 75	12	1,32	150	212	<input type="checkbox"/> 6.990 <input checked="" type="checkbox"/> 7.170 <input checked="" type="checkbox"/> 7.180 <input type="checkbox"/> 7.360 <input checked="" type="checkbox"/> 7.540 <input checked="" type="checkbox"/> 7.550 <input type="checkbox"/> 7.380 <input checked="" type="checkbox"/> 7.560 <input checked="" type="checkbox"/> 7.570

- Vetro extrachiaro / extra clear glass / extrahelles Glas / verre extra clair
 Vetro fumé / smoked glass / Rauchglas / verre fumé
 Vetro bronzo / bronze glass / Bronze Glas / Verre bronze

- basamento **nero grafite** / base **graphite black** / Gestell **Grafitsschwarz** / piètement **noir graphite**
 basamento **Dark Brown** / base **Dark Brown** / Gestell **Dark Brown** / piètement **Dark Brown**
 basamento **Champagne, Bronzo, Titanio o Red Jaipur** / base **Champagne, Bronzo, Titanio or Red Jaipur**
 Gestell **Champagnerfarbe, Bronzo, Titanio oder Red Jaipur** / piètement **Champagne, Bronzo, Titanio ou Red Jaipur**

**Specificare sempre la finitura del basamento verniciato / always specify finish of lacquered base
immer Ausführung des lackierten Gestells angeben / spécifier toujours finition du piètement laqué.**

- Tavolo con basamento centrale in metallo. Finiture: Bronzo, Titanio, Champagne, Dark Brown, Red Jaipur e verniciato nero grafite.
 Top in appoggio sagomati in vetro extrachiaro, fumé o bronzo.
 - Table with central base in metal. Finishes: Bronzo, Titanio, Champagne, Dark Brown, Red Jaipur and graphite black lacquered.
 Shaped tops in extra clear, smoked or bronze glass.
 - Tisch mit zentralem Gestell aus Metall. Ausführungen: Bronzo, Titanio, Champagne, Dark Brown, Red Jaipur und Grafitsschwarz lackiert.
 Profilerter Aufsatztop aus extrahellem, Rauch oder Bronze Glas.
 - Table avec base central en métal. Finitions: Bronzo, Titanio, Champagne, Dark Brown, Red Jaipur et laqué noir graphite.
 Plateaux profilés en verre extra clair, fumé ou bronze.

	I	dimensioni	spessore	volume	carico ammesso	peso	prezzo
	E	dimension	thickness	volume	admitted load	weight	price
	D	abmessungen	stärke	volumen	tragfähigkeit	gewicht	preis
	F	dimension	épaisseur	volume	charge admise	poids	prix
		cm	mm	m3	kg	kg	euro

Codex

design Giulio Mancini 2026

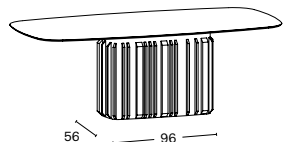

200 x 110 x h 75	12	0,87	150	153	○	6.790
					○○	6.910
					○○○	6.930
220 x 110 x h 75	12	0,80	150	160	○	7.020
					○○	7.140
					○○○	7.160
240 x 110 x h 75	12	0,83	150	168	○	7.440
					○○	7.560
					○○○	7.580
260 x 110 x h 75	12	1,03	150	202	○	8.300
					○○	8.420
					○○○	8.440
280 x 110 x h 75	12	1,06	150	209	○	8.410
					○○	8.530
					○○○	8.540
300 x 120 x h 75	12	1,11	150	224	○	9.080
					○○	9.200
					○○○	9.220
320 x 120 x h 75	12	1,14	150	232	○	9.640
					○○	9.760
					○○○	9.780

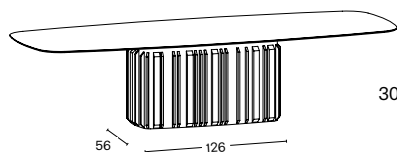

- basamento **nero grafite** / base **graphite black** / Gestell **Grafittschwarz** / piètement **noir graphite**
- basamento **Dark Brown** / base **Dark Brown** / Gestell **Dark Brown** / piètement **Dark Brown**
- basamento **Champagne, Bronzo o Titanio** / base **Champagne, Bronzo or Titanio** / Gestell **Champagnerfarbe, Bronzo oder Titanio** / piètement **Champagne, Bronzo ou Titanio**

Specificare sempre la finitura del basamento verniciato, dei listelli in legno

Siberian Ash, Eucalipto, Noce Canaletto o Rovere Naturale e del top laccato.

Always specify finish of lacquered base,

the **Siberian Ash, Eucalipto, Canaletto Walnut or Natural Oak** wood slats and the lacquered top.

Immer Ausführung des lackierten Gestells, der Holzleisten aus

Siberian Ash, Eucalipto, Walnuß Canaletto oder Natureiche und der Farbe der Tischplatte angeben.

Spécifier toujours finition du piètement laqué, des bandes de bois

Siberian Ash, Eucalipto, Noyer Canaletto ou rouvre naturel e la couleur du top.

- Tavolo con basamento centrale in metallo e listelli in legno massello in Siberian Ash, Eucalipto, Noce Canaletto e Rovere Naturale.

Finiture metallo: nero grafite, Dark Brown, Titanio, Champagne o Bronzo.

Top sagomato con bordo bisellato in vetro extrachiaro satinato laccato **nero, Dark Brown, Titanio, Champagne e Platino**.

- Table with central base in metal and Siberian Ash, Eucalipto, Canaletto Walnut or Natural Oak solid wood slats.

Metal base finishes: graphite black, Dark Brown, Titanio, Champagne or Bronzo.

Shaped top with bevelled edge in extra clear frosted glass lacquered **black, Dark Brown, Titanio, Champagne and Platino**.

- Tisch mit zentralem Gestell aus Metall und Massivholzleisten aus Siberian Ash, Eucalipto, Walnuß Canaletto und Natureiche.

Metallausführungen: Grafittschwarz, Dark Brown, Titanio, Champagnerfarbe oder Bronzo.

Profilierter Top mit Facettenschliff aus extrahell satinierem Glas **schwarz, Dark Brown, Titanio, Champagne und Platino**.

- Table avec base central en métal et bandes en bois massif en Siberian Ash, Eucalipto, Noyer Canaletto et rouvre naturel.

Finitions métal: noir graphite, Dark Brown, Titanio, Champagne ou Bronzo.

Top profilé avec bord biseauté en verre extra clair satiné laqué **noir, Dark Brown, Titanio, Champagne et Platino**.

	I	dimensioni	spessore	volume	carico ammesso	peso	prezzo
	E	dimension	thickness	volume	admitted load	weight	price
	D	abmessungen	stärke	volumen	tragfähigkeit	gewicht	preis
	F	dimension	épaisseur	volume	charge admise	poids	prix
		cm	mm	m3	kg	kg	euro

Codex ceramic

design Giulio Mancini 2026

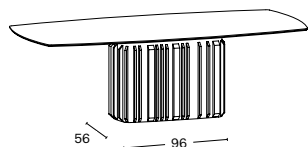

200 x 110 x h 75	8 + 5	0,78	150	153	○	6.680
					○○	6.800
					○○○	6.820
240 x 115 x h 75	8 + 5	0,84	150	170	○	7.420
					○○	7.540
					○○○	7.560
280 x 115 x h 75	8 + 5	1,07	150	210	○	7.830
					○○	7.950
					○○○	7.970
320 x 115 x h 75	10 + 5	1,13	150	230	○	8.500
					○○	8.620
					○○○	8.640

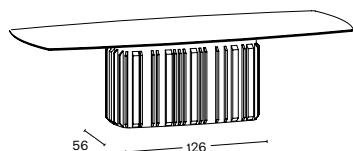

- basamento **nero grafite** / base **graphite black** / Gestell **Grafit schwarz** / piètement **noir graphite**
- basamento **Dark Brown** / base **Dark Brown** / Gestell **Dark Brown** / piètement **Dark Brown**
- basamento **Champagne, Bronzo o Titanio** / base **Champagne, Bronzo or Titanio** / Gestell **Champagnerfarbe, Bronzo oder Titanio** / piètement **Champagne, Bronzo ou Titanio**

Specificare sempre la finitura del basamento verniciato, dei listelli in legno **Siberian Ash, Eucalipto, Noce Canaletto o Rovere Naturale** e del top in ceramica.
 Always specify finish of lacquered base, the **Siberian Ash, Eucalipto, Canaletto Walnut or Natural Oak** wood slats and the ceramic top.
 Immer Ausführung des lackierten Gestells, der Holzleisten aus **Siberian Ash, Eucalipto, Walnuß Canaletto oder Natureiche** und der Tischplatte aus Keramik angeben.
 Spécifier toujours finition du piètement laqué, des bandes de bois **Siberian Ash, Eucalipto, Noyer Canaletto ou rouvre naturel** e du top en céramique.

- Tavolo con basamento centrale in metallo e listelli in legno massello in Siberian Ash, Eucalipto, Noce Canaletto e Rovere Naturale.
 Finiture metallo: nero grafite, Dark Brown, Titanio, Champagne o Bronzo.
 Top sagomati in ceramica + vetro nelle seguenti finiture: **Pietra di Savoia antracite bocciardato, Noir desir lucido o opaco, Calacatta oro venato lucido, Pietra Grey opaco, Sahara noir lucido o bocciardato e Travertino.**
- Table with central base in metal and solid wood slats in Siberian Ash, Eucalipto, Walnut Canaletto and natural oak.
 Metal finishes: graphite black, Dark Brown, Titanio, Champagne or Bronzo.
 Shaped tops made of ceramic+glass with following finishes: **Pietra di Savoia anthracite bushhammered, Noir desir polished or matt, Calacatta oro venato polished, Pietra Grey matt, Sahara noir polished or bushhammered or Travertino.**
- Tisch mit zentralem Gestell aus Metall und Massivholzleisten aus Siberian Ash, Eucalipto, Walnuß Canaletto und Natureiche.
 Metallausführungen: Grafit schwarz, Dark Brown, Titanio, Champagnerfarbe oder Bronzo.
 Profilierte Tischplatten aus Keramik+Glas in folgenden Ausfertigungen: **Pietra di Savoia Anthrazit bocciardato, Noir desir glänzend oder matt, Calacatta oro venato glänzend, Pietra Grey matt, Sahara noir glänzend oder bocciardato oder Travertino.**
- Table avec base central en métal et bandes en bois massif en Siberian Ash, Eucalipto, Noyer Canaletto et rouvre naturel.
 Finitions métal: noir graphite, Dark Brown, Titanio, Champagne ou Bronzo.
 Top profilé en céramique+verre dans les suivants finitions : **Pietra di Savoia anthracite bouchardé, Noir desir brillant ou mat, Calacatta oro venato brillant, Pietra Grey mat, Sahar noir brillant ou bouchardé ou Travertino.**

Codex stone

design Giulio Mancini 2026

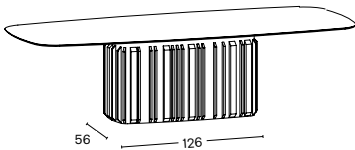
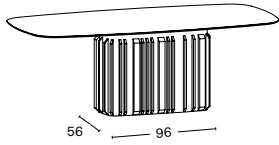

dimensioni dimension dimensionen	spessore thickness stärke épaisseur	volume volumen volumen	carico ammesso admitted load tragfähigkeit charge admise	peso weight poids	prezzo price preis prix						
cm	mm	m3	kg	kg	euro						
200 x 115 x h.75	20	0,86	150	218	Finiture top marmo / marble top finishes Marmortop Ausführungen / top marbre finitions						
					N.Marquinia Bianco Carrara	Sahara Noir	Travertino Romano	Arabescato Orobico Gold	Tropikal Storm	Domus White	
					○	9.730	10.730	11.310	12.780	13.500	14.110
					○○	9.850	10.850	11.430	12.900	13.620	14.230
					○○○	9.870	10.870	11.450	12.920	13.640	14.250
					Finiture top marmo / marble top finishes Marmortop Ausführungen / top marbre finitions						
					N.Marquinia Bianco Carrara	Sahara Noir	Travertino Romano	Arabescato Orobico Gold	Tropikal Storm	Domus White	
					○	10.210	11.310	12.970	14.580	15.380	16.050
					○○	10.330	11.430	13.090	14.700	15.500	16.170
					○○○	10.350	11.450	13.110	14.720	15.520	16.190
240 x 120 x h.75	20	0,92	150	258	Finiture top marmo / marble top finishes Marmortop Ausführungen / top marbre finitions						
					N.Marquinia Bianco Carrara	Sahara Noir	Travertino Romano	Arabescato Orobico Gold	Tropikal Storm	Domus White	
					○	10.930	12.200	14.260	15.240	16.220	16.880
					○○	11.050	12.320	14.380	15.360	16.340	17.000
					○○○	11.070	12.340	14.400	15.380	16.360	17.120
					Finiture top marmo / marble top finishes Marmortop Ausführungen / top marbre finitions						
					N.Marquinia Bianco Carrara	Sahara Noir	Travertino Romano	Arabescato Orobico Gold	Tropikal Storm	Domus White	
					○	11.570	12.940	15.140	16.200	17.240	18.040
					○○	11.690	13.060	15.260	16.320	17.360	18.160
					○○○	11.710	13.080	15.280	16.340	17.380	18.180
280 x 120 x h.75	20	1,16	150	314	Finiture top marmo / marble top finishes Marmortop Ausführungen / top marbre finitions						
					N.Marquinia Bianco Carrara	Sahara Noir	Travertino Romano	Arabescato Orobico Gold	Tropikal Storm	Domus White	
					○	12.220	13.680	16.080	17.440	18.590	19.470
					○○	12.340	13.800	16.200	17.560	18.710	19.590
					○○○	12.360	13.820	16.220	17.580	18.730	19.610

- basamento **nero grafite** / base **graphite black** / Gestell **Grafitschwarz** / piètement **noir graphite**
- basamento **Dark Brown** / base **Dark Brown** / Gestell **Dark Brown** / piètement **Dark Brown**
- basamento **Champagne, Bronzo o Titanio** / base **Champagne, Bronzo or Titanio**
Gestell **Champagnerfarbe, Bronzo oder Titanio** / piètement **Champagne, Bronzo ou Titanio**

Specificare sempre la finitura del basamento verniciato, dei listelli in legno **Siberian Ash, Eucalipto, Noce Canaletto o Rovere Naturale** e del top in marmo.

Always specify finish of lacquered base, the **Siberian Ash, Eucalipto, Canaletto Walnut or Natural Oak** wood slats and the marble top.

Immer Ausführung des lackierten Gestells, der Holzleisten aus **Siberian Ash, Eucalipto, Walnuß Canaletto oder Natureiche** und der Marmorplatte angeben.

Spécifier toujours finition du piètement laqué, des bandes de bois **Siberian Ash, Eucalipto, Noyer Canaletto ou rovere naturel** e du top en marbre.

Spécifier toujours finition du piètement laqué, des bandes de bois **Siberian Ash, Eucalipto, Noyer Canaletto ou rovere naturel** e du top en marbre.

- Tavolo con basamento centrale in metallo e listelli in legno massello in Siberian Ash, Eucalipto, Noce Canaletto e Rovere Naturale.
Finiture metallo: nero grafite, Dark Brown, Titanio, Champagne o Bronzo. Top sagomato con bordo bisellato in marmo spazzolato opaco.
Finiture: Nero Marquina, Bianco Carrara, Arabescato Orobico Gold, Sahara Noir, Tropikal Storm, Domus White e Travertino Romano.

- Table with central base in metal and solid wood slats in Siberian Ash, Eucalipto, Walnut Canaletto and natural oak.

Metal finishes: graphite black, Dark Brown, Titanio, Champagne or Bronzo. Shaped tops in matt brushed marble with bevelled edge.

Finishes: Nero Marquina, Bianco Carrara, Arabescato Orobico Gold, Sahara Noir, Tropikal Storm, Domus White and Travertino Romano.

- Tisch mit zentralem Gestell aus Metall und Massivholzleisten aus Siberian Ash, Eucalipto, Walnuß Canaletto und Natureiche.

Metallausführungen: Grafitschwarz, Dark Brown, Titanio, Champagne oder Bronzo. Profilierte Tischplatte aus matt gebürstetem Marmor mit Facettenschliff am Rand.

Ausführungen: Nero Marquina, Bianco Carrara, Arabescato Orobico Gold, Sahara Noir, Tropikal Storm, Domus White und Travertino Romano.

- Table avec base central en métal et bandes en bois massif en Siberian Ash, Eucalipto, Noyer Canaletto et rovere naturel.

Finitions métal: noir graphite, Dark Brown, Titanio, Champagne ou Bronzo. Top profilé en marbre brossé matte avec bord biseauté.

Finitions : Nero Marquina, Bianco Carrara, Arabescato Orobico Gold, Sahara Noir, Tropikal Storm, Domus White et Travertino Romano.

	I	dimensioni	spessore	volume	carico ammesso	peso	prezzo
	E	dimension	thickness	volume	admitted load	weight	price
	D	abmessungen	stärke	volumen	tragfähigkeit	gewicht	preis
	F	dimension	épaisseur	volume	charge admise	poids	prix
		cm	mm	m3	kg	kg	euro

Crossover design Massimo Castagna 2021	220 x 130 x h 75	B 10+10 T 15/10+6	0,641	150	248	□ 13.920 ■ 14.460 ■ 14.470
	240 x 130 x h 75	B 10+10 T 15/10+6	0,670	150	260	□ 14.390 ■ 14.890 ■ 14.900
	260 x 130 x h 75	B 10+10 T 15/10+6	0,699	150	272	□ 14.690 ■ 15.170 ■ 15.180
	280 x 130 x h 75	B 10+10 T 15/10+6	0,747	150	301	□ 15.320 ■ 16.060 ■ 16.070
	300 x 130 x h 75	B 10+10 T 15/10+6	0,776	150	313	□ 15.360 ■ 16.190 ■ 16.200
	320 x 130 x h 75	B 10+10 T 15/10+6	0,805	150	325	□ 15.580 ■ 16.310 ■ 16.320

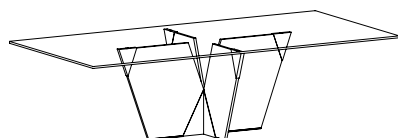

	150 x 150 x h 75	B 10+10 T 15/10+6	0,554	150	210	□ 13.660 ■ 13.910 ■ 13.920
--	------------------	-------------------	-------	-----	-----	----------------------------

	180 x 180 x h 75	B 10+10 T 15/10+6	0,701	150	286	□ 14.980 ■ 15.430 ■ 15.440
--	------------------	-------------------	-------	-----	-----	----------------------------

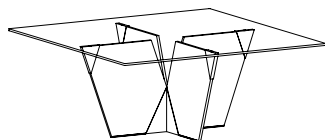

- top e basamento vetro extrachiaro / extra clear glass top and base
Top und Gestell aus extrahellem Glas / top et piètement en verre extra clair
- top e basamento vetro fumè / smoked glass top and base
Top und Gestell aus Rauchglas / top et piètement en verre fumé
- top e basamento vetro bronzo / bronze glass top and base
Top und Gestell aus Bronze Glas / top et piètement en verre bronze

Specificare sempre la finitura esterna delle parti metalliche.
Always specify external finish of metal part.
Immer Anfertigung der Außenseite der Metallteile angeben.
Indiquer toujours finition extérieur des parties en métal.

- Tavolo con basamento centrale in vetro stratificato 10+10mm, caratterizzato da un giunto piramidale in metallo e supporti top in finitura canna di fucile lucido o Titanio opaco.
Top e basamento in vetro extrachiaro, fumè e bronzo. I tops in vetro fumè e bronzo sono sempre stratificati.
- Table with central base made of stratified glass 10+10mm, featuring a pyramidal metal joint and top supports in polished gunmetal or matt Titanio.
Top and base in extra clear, smoked or bronze glass. Table tops in smoked or bronze glass are always stratified.
- Tisch mit zentralem Gestell aus Schichtglas 10+10mm, pyramidenförmiges Verbindungsstück aus Metall und Topplattenträger in glänzendem Gunmetal oder matt Titanio.
Top und Gestell aus extrahellem, Rauch oder Bronze Glas. Topplatten aus Rauch oder Bronze Glas sind immer aus Schichtglas.
- Table avec piètement central en verre stratifié 10+10mm, marqué par un joint pyramidal et supports top en finition gunmetal brillant ou Titanio mat.
Top et piètement en verre extra clair, fumé ou bronze. Les tops en verre fumé ou bronze sont toujours en verre stratifié.

	I E D F	dimensioni dimension abmessungen dimension	spessore thickness stärke épaisseur	volume volume volumen volume	carico ammesso admitted load tragfähigkeit charge admise	peso weight gewicht poids	prezzo price preis prix
		cm	mm	m3	kg	kg	euro

Crossover

design Massimo Castagna 2021

240 x 130 x h 75	B 10+10 T 15/10+6	0,670	150	253	□ 14.630 ■ 15.120 ■ 15.130
------------------	-------------------	-------	-----	-----	----------------------------

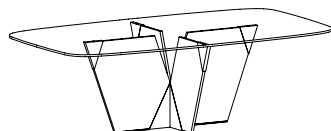

280 x 130 x h 75	B 10+10 T 15/10+6	0,747	150	293	□ 15.240 ■ 15.970 ■ 15.980
320 x 130 x h 75	B 10+10 T 15/10+6	0,805	150	317	□ 15.500 ■ 16.230 ■ 16.240

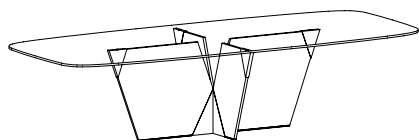

210 x 160 x h 75	B 10+10 T 15/10+6	0,693	150	247	□ 14.780 ■ 15.410 ■ 15.420
260 x 130 x h 75	B 10+10 T 15/10+6	0,699	150	244	□ 14.810 ■ 15.440 ■ 15.450

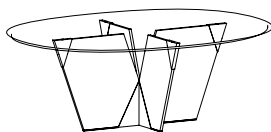

300 x 130 x h 75	B 10+10 T 15/10+6	0,776	150	280	□ 15.290 ■ 15.960 ■ 15.970
------------------	-------------------	-------	-----	-----	----------------------------

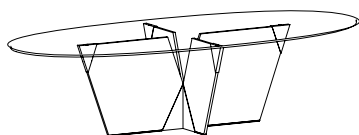

- top e basamento vetro extrachiaro / extra clear glass top and base
Top und Gestell aus extrahellem Glas / top et piètement en verre extra clair
- top e basamento vetro fumè / smoked glass top and base
Top und Gestell aus Rauchglas / top et piètement en verre fumé
- top e basamento vetro bronzo / bronze glass top and base
Top und Gestell aus Bronze Glas / top et piètement en verre bronze

Specificare sempre la finitura esterna delle parti metalliche.

Always specify external finish of metal part.

Immer Anfertigung der Außenseite der Metallteile angeben.

Indiquer toujours finition extérieur des parties en métal.

- Tavolo con basamento centrale in vetro stratificato 10+10mm, caratterizzato da un giunto piramidale in metallo e supporti top in finitura canna di fucile lucido o Titanio opaco.
Top e basamento in vetro extrachiaro, fumè e bronzo. I tops in vetro fumè e bronzo sono sempre stratificati.
- Table with central base made of stratified glass 10+10mm, featuring a pyramidal metal joint and top supports in polished gunmetal or matt Titanio.
Top and base in extra clear, smoked or bronze glass. Table tops in smoked or bronze glass are always stratified.
- Tisch mit zentralem Gestell aus Schichtglas 10+10mm, pyramidenförmiges Verbindungsstück aus Metall und Topplattenträger in glänzendem Gunmetal oder matt Titanio.
Top und Gestell aus extrahellem, Rauch oder Bronze Glas. Topplatten aus Rauch oder Bronze Glas sind immer aus Schichtglas.
- Table avec piètement central en verre stratifié 10+10mm, marqué par un joint pyramidal et supports top en finition gunmetal brillant ou Titanio mat.
Top et piètement en verre extra clair, fumé ou bronze. Les tops en verre fumé ou bronze sont toujours en verre stratifié.

	I E D F	dimensioni dimension abmessungen dimension	spessore thickness stärke épaisseur	volume volume volumen volume	carico ammesso admitted load tragfähigkeit charge admise	peso weight gewicht poids	prezzo price preis prix
		cm	mm	m3	kg	kg	euro

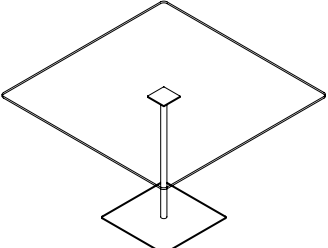
Farniente quadrato design G.T. Garattoni 2005/2024 	90x90 x h 73	12	0,123	120	50	<input type="checkbox"/> 1.970 <input checked="" type="checkbox"/> 2.000 <input type="checkbox"/> 2.020
	110x110 x h 73	12	0,180	120	70	<input type="checkbox"/> 2.170 <input checked="" type="checkbox"/> 2.210 <input type="checkbox"/> 2.240

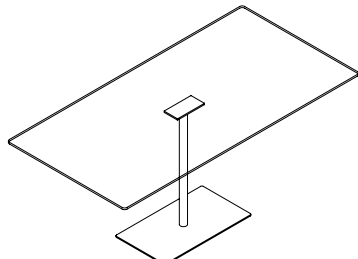
Farniente rettangolare design G.T. Garattoni 2005 /2024 	130 x 70 x h 73	12	0,183	120	68	<input type="checkbox"/> 2.230 <input checked="" type="checkbox"/> 2.260 <input type="checkbox"/> 2.280
	150 x 80 x h 73	12	0,185	120	75	<input type="checkbox"/> 2.380 <input checked="" type="checkbox"/> 2.420 <input type="checkbox"/> 2.450

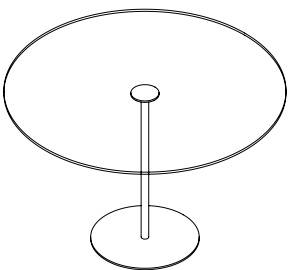
Farniente tondo design G.T. Garattoni 2005 /2024 	Ø 70 x h 73	12	0,100	120	38	<input type="checkbox"/> 1.830 <input checked="" type="checkbox"/> 1.850 <input type="checkbox"/> 1.870
	Ø 90 x h 73	12	0,123	120	45	<input type="checkbox"/> 2.100 <input checked="" type="checkbox"/> 2.130 <input type="checkbox"/> 2.150
	Ø 110 x h 73	12	0,180	120	68	<input type="checkbox"/> 2.310 <input checked="" type="checkbox"/> 2.350 <input type="checkbox"/> 2.380
	Ø 120 x h 73	12	0,190	120	75	<input type="checkbox"/> 2.450 <input checked="" type="checkbox"/> 2.490 <input type="checkbox"/> 2.520

Maggiorazione basamento in finitura: **canna di fucile o Champagne** 330
 Upcharge for base in finish: **gunmetal or Champagne**
 Aufpreis für Gestell aus: **Gunmetal oder Champagne**
 Surcharge pour base en: **canon de fusil ou Champagne**

- Vetro extrachiaro / extra clear glass / extrahelles Glas / verre extra clair
- Vetro fumé / smoked glass / Rauchglas / verre fumé
- Vetro bronzo / bronze glass / Bronze Glas / Verre bronze

- Tavolo in vetro extrachiaro, fumé o bronzo con basamento in finitura cromata, canna di fucile o Champagne.
- Table in extra clear, smoked or bronze glass with base in chrome, gunmetal or Champagne finish.
- Tisch aus extrahellem Glas, Rauchglas oder Bronze Glas mit Gestell in Chrom, gunmetal oder Champagne.
- Table en verre extra clair, fumé ou bronze, piètement en chrome, canon de fusil ou Champagne.

	I	dimensioni	spessore	volume	carico ammesso	peso	prezzo
	E	dimension	thickness	volume	admitted load	weight	price
	D	abmessungen	stärke	volumen	tragfähigkeit	gewicht	preis
	F	dimension	épaisseur	volume	charge admise	poids	prix
		cm	mm	m3	kg	kg	euro

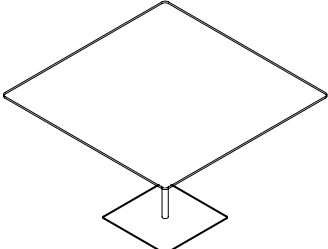
Farniente ceramic quadrato design G.T. Garattoni 2026 	90 x 90 x h 73	8 + 5	0,123	120	50	2.270
	110 x 110 x h 73	8 + 5	0,180	120	70	2.590

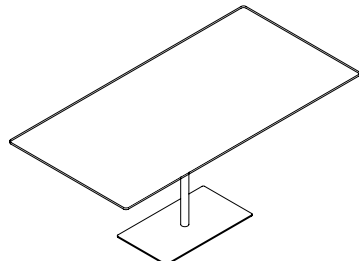
Farniente ceramic rettangolare design G.T. Garattoni 2026 	130 x 70 x h 73	8 + 5	0,183	120	68	2.530
	150 x 80 x h 73	8 + 5	0,185	120	75	2.770

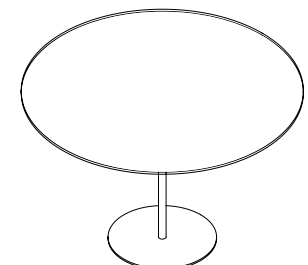
Farniente ceramic tondo design G.T. Garattoni 2026 	Ø 70 x h 73	8 + 5	0,100	120	38	1.980
	Ø 90 x h 73	8 + 5	0,123	120	45	2.410
	Ø 110 x h 73	8 + 5	0,180	120	68	2.730
	Ø 120 x h 73	8 + 5	0,190	120	75	2.940

Maggiorazione basamento in finitura: **canna di fucile o Champagne** 330
 Upcharge for base in finish: **gunmetal or Champagne**
 Aufpreis für Gestell aus: **Gunmetal oder Champagne**
 Surcharge pour base en: **canon de fusil ou Champagne**

- Top in ceramica + vetro nelle seguenti finiture: **Pietra di Savoia antracite bocciardato, Noir desir lucido o opaco, Calacatta oro venato lucido, Pietra Grey opaco, Sahara noir lucido o bocciardato e Travertino.**
 Basamento in finitura cromata, canna di fucile o Champagne.
- Top made of ceramic+glass with following finishes: **Pietra di Savoia anthracite bushhammered, Noir desir polished or matt, Calacatta oro venato polished, Pietra Grey matt, Sahara noir polished or bushhammered or Travertino.**
 Base in chrome, gunmetal or Champagne finish.
- Top aus Keramik+Glas in folgenden Ausfertigungen: **Pietra di Savoia Anthrazit bocciardato, Noir desir glänzend oder matt, Calacatta oro venato glänzend, Pietra Grey matt, Sahara noir glänzend oder bocciardato oder Travertino.**
 Gestell in Chrom, gunmetal oder Champagne.
- Top en céramique+verre dans les suivants finitions: **Pietra di Savoia anthracite bouchardé, Noir desir brillant ou matt, Calacatta oro venato brillant, Pietra Grey mat, Sahar noir brillant ou bouchardé ou Travertino.**
 Piètement en chrome, canon de fusil ou Champagne.

	I E D F	dimensioni dimension abmessungen dimension	spessore thickness stärke épaisseur	volume volume volumen volume	carico ammesso admitted load tragfähigkeit charge admise	peso weight gewicht poids	prezzo price preis prix
		cm	mm	m3	kg	kg	euro
Hybrid design Massimo Castagna 2022		Ø 140 x h 75	12	0,57	150	168	<input type="checkbox"/> 8.750 <input checked="" type="checkbox"/> 8.850 <input type="checkbox"/> 8.860
		Ø 160 x h 75	12	0,62	150	192	<input type="checkbox"/> 9.540 <input checked="" type="checkbox"/> 9.660 <input type="checkbox"/> 9.670
		Ø 180 x h 75	12	0,69	150	202	<input type="checkbox"/> 9.950 <input checked="" type="checkbox"/> 10.160 <input type="checkbox"/> 10.170

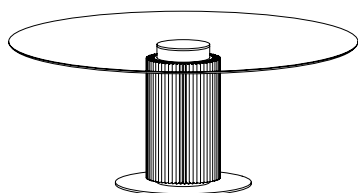

Maggiorazione base in finitura **canna di fucile**
 Upcharge base in **gunmetal**
 Aufpreis für Gestell in **Gunmetal**
 Surcharge pour piètement en **gunmetal**

230

- Vetro extrachiaro / extra clear glass / extrahelles Glas / verre extra clair
- Vetro fumé / smoked glass / Rauchglas / verre fumé
- Vetro bronzo / bronze glass / Glas Bronze / verre bronze

specificare sempre la finitura della base e dei listelli in legno massello.
always specify finish of base and solid wood strips.
immer Ausführung des Gestells und der Leisten aus massivem Holz angeben.
toujours spécifier la finition du piètement e des barres en bois massif.

- Tavolo con piano smussato sul bordo in vetro extra chiaro, fumé o bronzo temperato. Basamento centrale composto da listelli in legno massello **Siberian Ash, Eucalipto o Rovere naturale** e parte superiore in metallo sempre in finitura cromato lucido. Base a terra in finitura cromato lucido o canna di fucile lucido.
- Dining table with beveled top in extra clear, smoked or bronze tempered glass. Central base made of solid wood strips in **Siberian Ash, Eucalipto or Natural oak** and metal upper part always in polished chrome finish. Bottom plate in polished chrome or polished gunmetal.
- Esstisch mit Top mit abgeschrägten Kanten aus Sicherheitsglas extrahell, Rauchglas oder Bronze. Zentrales Gestell aus massiven Holzleisten in **Siberian Ash, Eucalipto oder Eiche Natur** und oberes Metallteil immer in Chrom glänzend. Grundplatte in Ausführung Chrom glänzend oder Gunmetal glänzend.
- Table haute avec top biseauté en verre trempé extra clair, fumé ou bronze. Piètement central composé de barres en bois massif **Siberian Ash, Eucalipto ou Rouvere naturel** et parte supérieur en métal toujours en finition chrome brillant. Plateau au fond en finition chrome brillant ou gunmetal brillant.

	I E D F	dimensioni dimension abmessungen dimension	spessore thickness stärke épaisseur	volume volume volumen volume	carico ammesso admitted load tragfähigkeit charge admise	peso weight gewicht poids	prezzo price preis prix
		cm	mm	m3	kg	kg	euro
Hybrid design Massimo Castagna 2022		140 x 140 x h 75	12	0,57	150	181	<input type="checkbox"/> 8.770 <input checked="" type="checkbox"/> 8.870 <input checked="" type="checkbox"/> 8.880
		160 x 160 x h 75	12	0,62	150	207	<input type="checkbox"/> 9.580 <input checked="" type="checkbox"/> 9.700 <input checked="" type="checkbox"/> 9.710
		180 x 180 x h 75	12	0,69	150	219	<input type="checkbox"/> 9.990 <input checked="" type="checkbox"/> 10.200 <input checked="" type="checkbox"/> 10.210

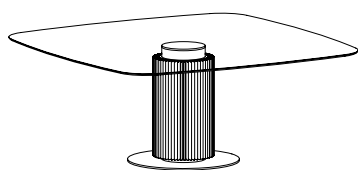

Maggiorazione base in finitura **canna di fucile**
 Upcharge base in **gunmetal**
 Aufpreis für Gestell in **Gunmetal**
 Surcharge pour piètement en **gunmetal**

230

- Vetro extrachiaro / extra clear glass / extrahelles Glas / verre extra clair
- Vetro fumé / smoked glass / Rauchglas / verre fumé
- Vetro bronzo / bronze glass / Glas Bronze / verre bronze

specificare sempre la finitura della base e dei listelli in legno massello.
always specify finish of base and solid wood strips.
immer Ausführung des Gestells und der Leisten aus massivem Holz angeben.
toujours spécifier la finition du piètement e des barres en bois massif.

- Tavolo con piano smussato sul bordo in vetro extra chiaro, fumé o bronzo temperato. Basamento centrale composto da listelli in legno massello **Siberian Ash, Eucalipto o Rovere naturale** e parte superiore in metallo sempre in finitura cromato lucido. Base a terra in finitura cromato lucido o canna di fucile lucido.
- Dining table with beveled top in extra clear, smoked or bronze tempered glass. Central base made of solid wood strips in **Siberian Ash, Eucalipto or Natural oak** and metal upper part always in polished chrome finish. Bottom plate in polished chrome or polished gunmetal.
- Esstisch mit Top mit abgeschrägten Kanten aus Sicherheitsglas extrahell, Rauchglas oder Bronze. Zentrales Gestell aus massiven Holzleisten in **Siberian Ash, Eucalipto oder Eiche Natur** und oberes Metallteil immer in Chrom glänzend. Grundplatte in Ausführung Chrom glänzend oder Gunmetal glänzend.
- Table haute avec top biseauté en verre trempé extra clair, fumé ou bronze. Piètement central composé de barres en bois massif **Siberian Ash, Eucalipto ou Rouvre naturel** et parte supérieur en métal toujours en finition chrome brillant. Plateau au fond en finition chrome brillant ou gunmetal brillant.

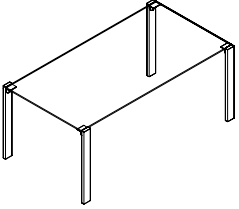
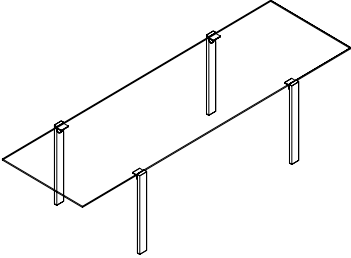
	I E D F	dimensioni dimension abmessungen dimension	spessore thickness stärke épaisseur	volume volume volumen volume	carico ammesso admitted load tragfähigkeit charge admise	peso weight gewicht poids	prezzo price preis prix
		cm	mm	m3	kg	kg	euro
Livingstand design Giulio Mancini 2006/2011 		120 x 90 x h 74	15	0,12	170	70	<input type="checkbox"/> 2.690
		140 x 90 x h 74	15	0,21	170	78	<input type="checkbox"/> 2.850
		160 x 90 x h 74	15	0,23	170	87	<input type="checkbox"/> 2.930
		180 x 90 x h 74	15	0,25	170	89	<input type="checkbox"/> 3.090
		200 x 100 x h 74	15	0,12	170	114	<input type="checkbox"/> 3.530
		220 x 100 x h 74	15	0,33	170	124	<input type="checkbox"/> 3.640
		240 x 100 x h 74	15	0,36	170	134	<input type="checkbox"/> 3.750
		260 x 100 x h 74	15	0,38	170	144	<input type="checkbox"/> 3.880
		280 x 100 x h 74	15	0,41	170	154	<input type="checkbox"/> 3.990

Maggiorazione per gambe in finitura: **BRONZO, CANNA DI FUCILE E CHAMPAGNE.**

240

Surcharge for legs finishing in: **BRONZE, GUNMETAL OR CHAMPAGNE.**

Aufpreis für Beine in Ausführung: **BRONZE, GUNMETAL ODER CHAMPAGNE.**

Surcoût pour pieds en finition: **BRONZE, GUNMETAL OU CHAMPAGNE.**

Piano extrachiaro / extra clear glass top / Glasplatte extrahell / Plateau en verre extra clair

SPECIFICARE SEMPRE FINITURA GAMBE. / ALWAYS SPECIFY LEGS FINISHING.

IMMER DIE AUSFÜHRUNG DER BEINE ANGEBEN. / SPECIFIEZ TOUJOURS LA FINITION DES PIEDS.

- Tavolo in vetro temprato extrachiaro. Gambe in metallo cromato, CROMATO OPACO, verniciate opaco bianche o nere.
- Dining table in tempered extra clear glass. Legs in chrome, MATT CHROME, black or white matt lacquered.
- Eßtisch aus Sicherheitsglas extrahell. Beine verchromt, CHROM MATT, schwarz oder weiß matt lackiert.
- Table haut en verre trempé extra clair. Pieds chromés, CHROME OPAQUE, laqués noir ou blanc opaque.

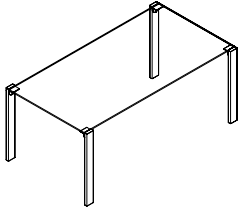
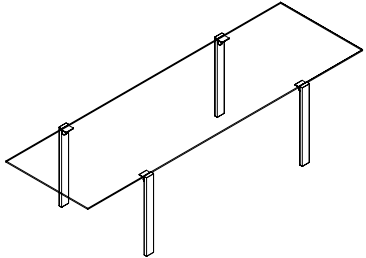
	I E D F	dimensioni dimension abmessungen dimension	spessore thickness stärke épaisseur	volume volume volumen volume	carico ammesso admitted load tragfähigkeit charge admise	peso weight gewicht poids	prezzo price preis prix
		cm	mm	m3	kg	kg	euro
Livingstand wood leg design Giulio Mancini 2000/2014 		120 x 90 x h 74	15	0,12	170	70	<input type="checkbox"/> 2.930
		140 x 90 x h 74	15	0,21	170	78	<input type="checkbox"/> 3.090
		160 x 90 x h 74	15	0,23	170	87	<input type="checkbox"/> 3.170
		180 x 90 x h 74	15	0,25	170	89	<input type="checkbox"/> 3.330
		200 x 100 x h 74	15	0,12	170	114	<input type="checkbox"/> 3.770
		220 x 100 x h 74	15	0,33	170	124	<input type="checkbox"/> 3.880
		240 x 100 x h 74	15	0,36	170	134	<input type="checkbox"/> 3.990
		260 x 100 x h 74	15	0,38	170	144	<input type="checkbox"/> 4.120
		280 x 100 x h 74	15	0,41	170	154	<input type="checkbox"/> 4.230

Piano extrachiaro / extra clear glass top / Glasplatte extrahell / Plateau en verre extra clair

**SPECIFICARE SEMPRE FINITURA GAMBE / ALWAYS SPECIFY LEGS FINISHING.
IMMER DIE AUSFÜHRUNG DER BEINE ANGEBEN / SPECIFIEZ TOUJOURS LA FINITION DES PIEDS.**

- Tavolo in vetro temprato extrachiaro.

Gambe in legno noce canaletto, rovere naturale, Siberian Ash oppure Eucalipto.

- Dining table tempered, extra clear glass.

Legs in canaletto walnut, natural oak, Siberian ash or Eucalipto.

- Eßtisch aus Sicherheitsglas extrahell.

Beine aus Walnuß Canaletto, Eiche Natur, Siberian Ash or Eucalipto.

- Table haut en verre trempé extra clair.

Pieds en noyer canaletto, rovere naturel, Siberian Ash ou Eucalipto.

	I E D F	dimensioni dimension abmessungen dimension	spessore thickness stärke épaisseur	volume volume volumen volume	carico ammesso admitted load tragfähigkeit charge admise	peso weight gewicht poids	prezzo price preis prix
		cm	mm	m3	kg	kg	euro

Livingstand Dark

design Giulio Mancini 2020

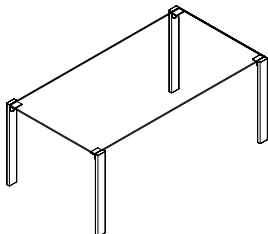

120 x 90 x h 74	10 + 6	0,12	170 *	70	■ 2.880 ■ 2.890
140 x 90 x h 74	10 + 6	0,12	170 *	78	■ 3.080 ■ 3.090
160 x 90 x h 74	10 + 6	0,23	170 *	87	■ 3.190 ■ 3.200
180 x 90 x h 74	10 + 6	0,25	170 *	96	■ 3.380 ■ 3.390

Maggiorazione per gambe in finitura:

BRONZO, CANNA DI FUCILE LUCIDO o CHAMPAGNE

240

Surcharge for legs finishing in:

BRONZE, GUNMETAL POLISHED or CHAMPAGNE

Aupreis für Beine in Ausführung:

BRONZE, GUNMETAL GLÄNZEND oder CHAMPAGNE

Augmentation pieds en finition:

BRONZE, GUNMETAL BRILLANT ou CHAMPAGNE

Maggiorazione per gambe in LEGNO finitura:

NOCE CANALETTO, ROVERE NATURALE, SIBERIAN ASH oppure EUCALIPTO

240

Surcharge for legs in WOOD finishing:

WALNUT CANALETTO, NATURAL OAK, SIBERIAN ASH or EUCALIPTO

Aufpreis für Beine aus HOLZ, Ausführung:

WALNUS CANALETTO, EICHE NATUR, SIBERIAN ASH oder EUCALIPTO

Augmentation pour pieds en BOIS, finition:

NOYER CANALETTO, ROUVRE NATUREL, SIBERIAN ASH ou EUCALIPTO

- Vetro Fumè / smoked glass / Rauchglas / verre fumé
- Vetro Bronzo / bronze glass / Glas Bronze / verre bronze

Specificare sempre finitura del vetro / Always specify glass finish

Immer Glasausführung angeben / Spécifiez toujours la finition du verre

Specificare sempre finitura gambe / Always specify legs finishing.

Immer die Ausführung der Beine angeben / Spécifiez toujours la finition des pieds.

* per tavolo / for table / für den Tisch / pour table

- Tavolo alto in vetro stratificato e temperato. Piano in vetro fumè o bronzo, gambe in metallo cromato lucido, cromato opaco, verniciato opaco bianco o nero.
- Table in stratified and tempered glass. Top in smoked or bronze glass, metal legs in chrome, matt chrome, matt black or white lacquered.
- Tisch in gehärtetem Schichtglas. Tischplatte aus Rauchglas oder Bronze Glas, Metallbeine in Chrom, Chrom matt, matt schwarz oder weiß lackiert.
- Table en verre stratifié et trempé. Plateau en verre fumé ou bronze, pieds en métal chromé, chromé mat, laqués noir ou blanc mat.

	I	dimensioni	spessore	volume	carico ammesso	peso	prezzo
	E	dimension	thickness	volume	admitted load	weight	price
	D	abmessungen	stärke	volumen	tragfähigkeit	gewicht	preis
	F	dimension	épaisseur	volume	charge admise	poids	prix
		cm	mm	m3	kg	kg	euro

Metropolis

design G. Maurizio Scutellà 2017

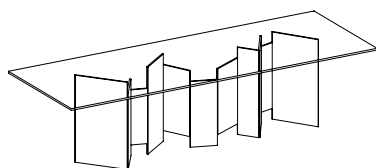

200 x 100 x h 75	12	0,58	150	115	<input type="checkbox"/> 2.990 <input checked="" type="checkbox"/> 3.120 <input checked="" type="checkbox"/> 3.280
220 x 100 x h 75	12	0,74	150	136	<input type="checkbox"/> 3.170 <input checked="" type="checkbox"/> 3.310 <input checked="" type="checkbox"/> 3.480
240 x 100 x h 75	12	0,93	150	148	<input type="checkbox"/> 3.330 <input checked="" type="checkbox"/> 3.470 <input checked="" type="checkbox"/> 3.650
260 x 100 x h 75	12	1,15	150	195	<input type="checkbox"/> 3.440 <input checked="" type="checkbox"/> 3.590 <input checked="" type="checkbox"/> 3.770
280 x 100 x h 75	12	1,32	150	219	<input type="checkbox"/> 3.840 <input checked="" type="checkbox"/> 4.000 <input checked="" type="checkbox"/> 4.210
300 x 100 x h 75	12	1,35	150	225	<input type="checkbox"/> 3.930 <input checked="" type="checkbox"/> 4.110 <input checked="" type="checkbox"/> 4.320

- top e basamento vetro extrachiaro / extra clear glass top and base
Top und Gestell aus extrahellem Glas / top et piètement en verre extra clair
- top e basamento vetro fumè / smoked glass top and base
Top und Gestell aus Rauchglas / top et piètement en verre fumé
- top e basamento vetro bronzo / bronze glass top and base
Top und Gestell aus Bronze Glas / top et piètement en verre bronze

- Tavolo con basamento centrale in vetro extrachiaro, fumè o bronzo.
Top in vetro extrachiaro, fumè o bronzo.
- Dining table with central base in extra clear, smoked or bronze glass.
Table top in extra clear, smoked or bronze glass.
- Esstisch mit zentralem Gestell aus extrahellem Glas, Rauchglas oder Bronze.
Topplatte aus extrahellem Glas, Rauchglas oder Bronze.
- Table avec piètement central en verre extra clair, fumé ou bronze.
Top en verre extra clair, fumé ou bronze.

	I	dimensioni	spessore	volume	carico ammesso	peso	prezzo
	E	dimension	thickness	volume	admitted load	weight	price
	D	abmessungen	stärke	volumen	tragfähigkeit	gewicht	preis
	F	dimension	épaisseur	volume	charge admise	poids	prix
		cm	mm	m3	kg	kg	euro

Metropolis ceramic

design G. Maurizio Scutellà 2017

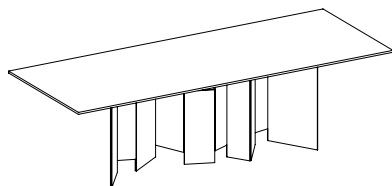

200x100 x h 75	12 / 8 + 5	0,58	150	115	<input type="checkbox"/> 3.880 <input checked="" type="checkbox"/> 3.980 <input checked="" type="checkbox"/> 4.190
220x100 x h 75	12 / 8 + 5	0,75	150	139	<input type="checkbox"/> 4.080 <input checked="" type="checkbox"/> 4.180 <input checked="" type="checkbox"/> 4.390
240x100 x h 75	12 / 8 + 5	0,80	150	144	<input type="checkbox"/> 4.370 <input checked="" type="checkbox"/> 4.470 <input checked="" type="checkbox"/> 4.690
260x100 x h 75	12 / 8 + 5	1,15	150	195	<input type="checkbox"/> 4.560 <input checked="" type="checkbox"/> 4.660 <input checked="" type="checkbox"/> 4.890
300x100 x h 75	12 / 8 + 5	1,35	150	225	<input type="checkbox"/> 5.420 <input checked="" type="checkbox"/> 5.520 <input checked="" type="checkbox"/> 5.790

240x115 x h 75	12 / 8 + 5	0,97	150	178	<input type="checkbox"/> 4.600 <input checked="" type="checkbox"/> 4.700 <input checked="" type="checkbox"/> 4.940
280x115 x h 75	12 / 8 + 5	1,14	150	210	<input type="checkbox"/> 5.650 <input checked="" type="checkbox"/> 5.750 <input checked="" type="checkbox"/> 6.040
320x115 x h 75	12 / 8 + 5	1,28	150	234	<input type="checkbox"/> 6.290 <input checked="" type="checkbox"/> 6.390 <input checked="" type="checkbox"/> 6.710

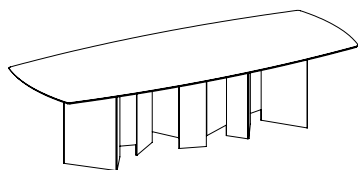

**SPECIFICARE SEMPRE LA FINITURA DEL TOP CERAMICA / ALWAYS SPECIFY CERAMIC TOP FINISH
IMMER DIE AUSFERTIGUNG DER KERAMIKPLATTE ANGEBEN / SPECIFIER TOUJOURS FINITION TOP EN CERAMIQUE**

- basamento in vetro extrachiaro / base in extra clear glass / Gestell aus extrahellem Glas / piètement en verre extra clair
- basamento in vetro fumè / base in smoked glass / Gestell aus Rauchglas / piètement en verre fumé
- basamento in vetro bronzo / base in bronze glass / Gestell aus Bronze Glas / piètement en verre bronze

- Tavolo con basamento in vetro extrachiaro, fumè o bronzo. Top in ceramica+vetro nelle seguenti finiture:

Pietra di Savoia antracite bocciardato, Noir desir lucido o opaco, Calacatta oro venato lucido, Pietra Grey opaco, Sahara noir lucido o bocciardato o Travertino.

- Dining table with base in extra clear, smoked or bronze glass. Top made of ceramic+glass with following finishes:

Pietra di Savoia anthracite bushhammered, Noir desir polished or matt, Calacatta oro venato polished, Pietra Grey matt, Sahara noir polished or bushhammered or Travertino.

- Esstisch mit Gestell aus extrahellem Glas, Rauchglas oder Bronze Glas. Top aus Keramik+Glas in folgenden Ausfertigungen:

Pietra di Savoia Anthrazit bocciardato, Noir desir glänzend oder matt, Calacatta oro venato glänzend, Pietra Grey matt, Sahara noir glänzend oder bocciardato oder Travertino.

- Table avec piètement en verre extra clair, fumé ou bronze. Top en céramique+verre dans les suivants finitions:

Pietra di Savoia anthracite bouchardé, Noir desir brillant ou mat, Calacatta oro venato brillant, Pietra Grey mat, Sahar noir brillant ou bouchardé ou Travertino.

	I	dimensioni	spessore	volume	carico ammesso	peso	prezzo
	E	dimension	thickness	volume	admitted load	weight	price
	D	abmessungen	stärke	volumen	tragfähigkeit	gewicht	preis
	F	dimension	épaisseur	volume	charge admise	poids	prix
		cm	mm	m3	kg	kg	euro

Metropolis fused glass

design G. Maurizio Scutellà 2023

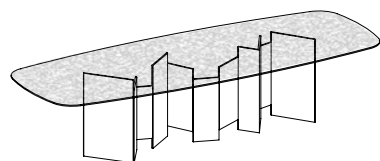

200 x 110 x h 75	12	0,59	150	115	■ 4.250 ■ 4.460
220 x 110 x h 75	12	0,73	150	135	■ 4.500 ■ 4.740
240 x 110 x h 75	12	0,94	150	145	■ 4.730 ■ 4.970
260 x 110 x h 75	12	1,16	150	190	■ 5.100 ■ 5.360
280 x 110 x h 75	12	1,34	150	210	■ 5.540 ■ 5.830
300 x 110 x h 75	12	1,38	150	225	■ 5.820 ■ 6.120
320 x 120 x h 75	12	1,42	150	250	■ 6.250 ■ 6.560

- basamento vetro fumè e top in vetro fuso fumè
base smoked glass and top fused smoked glass
Gestell Rauchglas und Top aus geschmolzenem Rauchglas
piètement verre fumé et top en verre en fusion fumé
- basamento vetro bronzo e top in vetro fuso bronzo
base bronze glass and top fused bronze glass
Gestell Bronze Glas und Top aus geschmolzenem Bronze Glas
piètement verre bronze et top verre en fusion bronze

- Tavolo con basamento centrale in vetro fumè o bronzo.
Top sagomato in vetro fuso fumè o bronzo.
- Dining table with central base in smoked or bronze glass.
Shaped top in fused smoked or bronze glass.
- Esstisch mit zentralem Gestell aus Rauchglas oder Bronze Glas. Profilerter
Top aus geschmolzenem Rauchglas oder Bronze.
- Table avec piètement central en verre fumé ou bronze.
Top profilé en verre en fusion fumé ou bronze.

	I E D F	dimensioni dimension abmessungen dimension	spessore thickness stärke épaisseur	volume volume volumen volume	carico ammesso admitted load tragfähigkeit charge admise	peso weight gewicht poids	prezzo price preis prix
		cm	mm	m3	kg	kg	euro

Nuvolari

design Nicola Bonriposi 2026

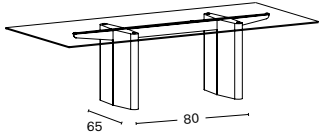
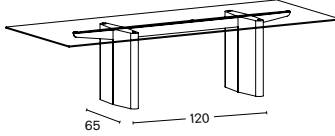
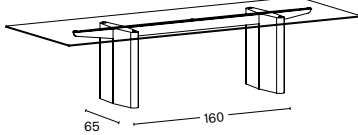
	200 x 100 x h 75	10	0,63	150	139	<input type="checkbox"/> 3.200 ■ 3.330 ■ 3.340 <input type="checkbox"/> 3.310 ■ 3.440 ■ 3.450 <input type="checkbox"/> 3.330 ■ 3.460 ■ 3.470
	220 x 100 x h 75	10	0,65	150	147	<input type="checkbox"/> 3.280 ■ 3.410 ■ 3.420 <input type="checkbox"/> 3.390 ■ 3.520 ■ 3.530 <input type="checkbox"/> 3.410 ■ 3.530 ■ 3.550
	240 x 100 x h 75	10	0,68	150	158	<input type="checkbox"/> 3.490 ■ 3.630 ■ 3.640 <input type="checkbox"/> 3.610 ■ 3.750 ■ 3.760 <input type="checkbox"/> 3.630 ■ 3.770 ■ 3.780
	260 x 100 x h 75	10	0,7	150	167	<input type="checkbox"/> 4.030 ■ 4.180 ■ 4.190 <input type="checkbox"/> 4.160 ■ 4.310 ■ 4.320 <input type="checkbox"/> 4.180 ■ 4.330 ■ 4.340
	280 x 100 x h 75	10	0,73	150	175	<input type="checkbox"/> 4.130 ■ 4.290 ■ 4.300 <input type="checkbox"/> 4.260 ■ 4.420 ■ 4.430 <input type="checkbox"/> 4.280 ■ 4.440 ■ 4.450
	300 x 100 x h 75	10	0,79	150	192	<input type="checkbox"/> 4.220 ■ 4.390 ■ 4.400 <input type="checkbox"/> 4.350 ■ 4.520 ■ 4.530 <input type="checkbox"/> 4.370 ■ 4.540 ■ 4.550
	320 x 120 x h 75	10	0,81	150	202	<input type="checkbox"/> 4.340 ■ 4.520 ■ 4.530 <input type="checkbox"/> 4.470 ■ 4.650 ■ 4.660 <input type="checkbox"/> 4.490 ■ 4.670 ■ 4.680

- Vetro extrachiaro / extra clear glass / extrahelles Glas / verre extra clair
 Vetro fumé / smoked glass / Rauchglas / verre fumé
 Vetro bronzo / bronze glass / Glas Bronze / verre bronze

- basamento **nero grafite** / base **graphite black** / Gestell **Grafit Schwarz** / piètement **noir graphite**
 basamento **Dark Brown** / base **Dark Brown** / Gestell **Dark Brown** / piètement **Dark Brown**
 basamento **Champagne, Bronzo o Titanio** / base **Champagne, Bronzo or Titanio**
 Gestell **Champagnerfarbe, Bronzo oder Titanio** / piètement **Champagne, Bronzo ou Titanio**

**Specificare sempre la finitura del basamento verniciato / always specify finish of lacquered base
immer Ausführung des lackierten Gestells angeben / spécifier toujours finition du piètement laqué.**

- Tavolo con basamento centrale in metallo. Finiture: Bronzo, Titanio, Champagne, Dark Brown e nero grafite.
 Top in appoggio rettangolari o sagomati in vetro extrachiaro, fumé o bronzo.
 - Table with central base in metal. Finishes: Bronze, Titanio, Champagne, Dark Brown and graphite black.
 Rectangular or shaped loose tops in extra clear, smoked or bronze glass.
 - Tisch mit zentralem Gestell aus Metall. Ausführungen: Bronzo, Titanio, Champagne, Dark Brown und Grafit Schwarz.
 Aufsitztop rechteckig oder profiliert aus extrahellem, Rauch- oder Bronze Glas.
 - Table avec base central en métal. Finitions: Bronze, Titanio, Champagne, Dark Brown et noir graphite.
 Plateaux rectangulaires ou profilés en verre extra-clair, fumé ou bronze.

	I	dimensioni	spessore	volume	carico ammesso	peso	prezzo
	E	dimension	thickness	volume	admitted load	weight	price
	D	abmessungen	stärke	volumen	tragfähigkeit	gewicht	preis
	F	dimension	épaisseur	volume	charge admise	poids	prix
		cm	mm	m3	kg	kg	euro

Nuvolari

design Nicola Bonriposi 2026

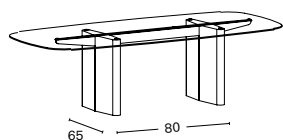

200 x 110 x h 75	10	0,64	150	141	○ □ 3.340 ■ 3.470 ■ 3.480 ○○ □ 3.450 ■ 3.580 ■ 3.590 ○○○ □ 3.470 ■ 3.600 ■ 3.610
220 x 110 x h 75	10	0,65	150	149	○ □ 3.420 ■ 3.550 ■ 3.560 ○○ □ 3.530 ■ 3.660 ■ 3.670 ○○○ □ 3.550 ■ 3.680 ■ 3.690
240 x 110 x h 75	10	0,69	150	160	○ □ 3.630 ■ 3.770 ■ 3.780 ○○ □ 3.750 ■ 3.890 ■ 3.900 ○○○ □ 3.770 ■ 3.910 ■ 3.920
260 x 110 x h 75	10	0,71	150	169	○ □ 4.170 ■ 4.320 ■ 4.330 ○○ □ 4.300 ■ 4.450 ■ 4.460 ○○○ □ 4.320 ■ 4.470 ■ 4.480
280 x 110 x h 75	10	0,74	150	177	○ □ 4.270 ■ 4.430 ■ 4.440 ○○ □ 4.400 ■ 4.560 ■ 4.570 ○○○ □ 4.420 ■ 4.580 ■ 4.590
300 x 120 x h 75	10	0,80	150	198	○ □ 4.360 ■ 4.530 ■ 4.540 ○○ □ 4.490 ■ 4.660 ■ 4.670 ○○○ □ 4.510 ■ 4.680 ■ 4.690
320 x 120 x h 75	10	0,81	150	202	○ □ 4.480 ■ 4.660 ■ 4.670 ○○ □ 4.610 ■ 4.790 ■ 4.800 ○○○ □ 4.630 ■ 4.810 ■ 4.820

- Vetro extrachiaro / extra clear glass / extrahelles Glas / verre extra clair
- Vetro fumé / smoked glass / Rauchglas / verre fumé
- Vetro bronzo / bronze glass / Glas Bronze / verre bronze

- basamento **nero grafite** / base **graphite black** / Gestell **Grafit schwarz** / piètement **noir graphite**
- basamento **Dark Brown** / base **Dark Brown** / Gestell **Dark Brown** / piètement **Dark Brown**
- basamento **Champagne, Bronzo o Titanio** / base **Champagne, Bronzo or Titanio**
Gestell **Champagnerfarbe, Bronzo oder Titanio** / piètement **Champagne, Bronzo ou Titanio**

**Specificare sempre la finitura del basamento verniciato / always specify finish of lacquered base
immer Ausführung des lackierten Gestells angeben / spécifier toujours finition du piètement laqué.**

- Tavolo con basamento centrale in metallo. Finiture: Bronzo, Titanio, Champagne, Dark Brown e nero grafite.
Top in appoggio rettangolari o sagomati in vetro extrachiaro, fumé o bronzo.
- Table with central base in metal. Finishes: Bronzo, Titanio, Champagne, Dark Brown and graphite black.
Rectangular or shaped tops in extra clear, smoked or bronze glass.
- Tisch mit zentralem Gestell aus Metall. Ausführungen: Bronzo, Titanio, Champagne, Dark Brown und Grafit schwarz.
Aufsitztop rechteckig oder profiliert aus extrahellem, Rauch- oder Bronze Glas.
- Table avec base central en métal. Finitions: Bronzo, Titanio, Champagne, Dark Brown et noir graphite.
Plateaux rectangulaires ou profilés en verre extra-clair, fumé ou bronze.

	I	dimensioni	spessore	volume	carico ammesso	peso	prezzo
	E	dimension	thickness	volume	admitted load	weight	price
	D	abmessungen	stärke	volumen	tragfähigkeit	gewicht	preis
	F	dimension	épaisseur	volume	charge admise	poids	prix
		cm	mm	m3	kg	kg	euro

Nuvolari ceramic

design Nicola Bonriposi 2026



200 x 100 x h 75	8 + 5	0,63	150	139	○ 3.980 ○○ 4.090 ○○○ 4.110
220 x 100 x h 75	8 + 5	0,65	150	147	○ 4.170 ○○ 4.280 ○○○ 4.300
240 x 100 x h 75	8 + 5	0,68	150	158	○ 4.320 ○○ 4.440 ○○○ 4.460
260 x 100 x h 75	8 + 5	0,7	150	167	○ 4.610 ○○ 4.740 ○○○ 4.760
300 x 100 x h 75	10 + 5	0,79	150	192	○ 5.180 ○○ 5.310 ○○○ 5.330
320 x 120 x h 75	10 + 5	0,81	150	202	○ 5.880 ○○ 6.010 ○○○ 6.030



200 x 110 x h 75	8 + 5	0,64	150	141	○ 4.130 ○○ 4.240 ○○○ 4.260
240 x 115 x h 75	8 + 5	0,7	150	160	○ 4.870 ○○ 4.990 ○○○ 5.010
280 x 115 x h 75	8 + 5	0,75	150	177	○ 6.280 ○○ 6.410 ○○○ 6.430
320 x 115 x h 75	10 + 5	0,8	150	202	○ 6.950 ○○ 7.080 ○○○ 7.100

- basamento **nero grafite** / base **graphite black** / Gestell **Grafitsschwarz** / piètement **noir graphite**
- basamento **Dark Brown** / base **Dark Brown** / Gestell **Dark Brown** / piètement **Dark Brown**
- basamento **Champagne, Bronzo o Titanio** / base **Champagne, Bronzo or Titanio**
Gestell **Champagnerfarbe, Bronzo oder Titanio** / piètement **Champagne, Bronzo ou Titanio**

Specificare sempre la finitura del basamento verniciato e della ceramica del top.

Always specify finish of laquered base and ceramic of top.

Immer Ausführung des lackierten Gestell angeben und Keramik des Tops.

Spécifier toujours finition du piètement laqué et céramique du top.

- Tavolo con basamento in metallo. Finiture: Bronzo, Titanio, Champagne, Dark Brown e nero grafite.
Top in appoggio in ceramica nelle finiture: **Pietra di Savoia antracite bocciardato, Noir desir lucido o opaco, Calacatta oro venato lucido, Pietra Grey opaco, Sahara noir lucido o bocciardato o Travertino.**
- Table with base in metal. Finishes: Bronzo, Titanio, Champagne, Dark Brown and graphite black lacquered.
Loose ceramic top in following finishes: **Pietra di Savoia anthracite bushhammered, Noir desir polished or matt, Calacatta oro venato polished, Pietra Grey matt, Sahara noir polished or bushhammered or Travertino.**
- Esstisch mit Gestell aus Metall. Ausführungen: Bronzo, Titanio, Champagne, Dark Brown und Grafitsschwarz.
Keramiktop in folgenden Ausführungen: **Pietra di Savoia Anthrazit bocciardato, Noir desir glänzend oder matt, Calacatta oro venato glänzend, Pietra Grey matt, Sahara noir glänzend oder bocciardato oder Travertino.**
- Table avec base en métal. Finitions: Bronzo, Titanio, Champagne, Dark Brown et noir graphite.
Top en céramique disponible en: **Pietra di Savoia anthracite bouchardé, Noir desir brillant ou mat, Calacatta oro venato brillant, Pietra Grey mat, Sahar noir brillant ou bouchardé ou Travertino.**

	I	dimensioni	spessore	volume	carico ammesso	peso	prezzo
	E	dimension	thickness	volume	admitted load	weight	price
	D	abmessungen	stärke	volumen	tragfähigkeit	gewicht	preis
	F	dimension	épaisseur	volume	charge admise	poids	prix
		cm	mm	m3	kg	kg	euro

Nuvolari fused glass

design Nicola Bonriposi 2026

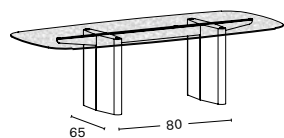

200 x 110 x h 75	10	0,64	150	141	○ ■ 4.070 ○ ■ 4.080
					○○ ■ 4.170 ○○ ■ 4.180
					○○○ ■ 4.190 ○○○ ■ 4.200

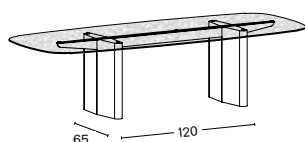

220 x 110 x h 75	10	0,65	150	149	○ ■ 4.220 ○ ■ 4.230
					○○ ■ 4.280 ○○ ■ 4.290
					○○○ ■ 4.300 ○○○ ■ 4.310

240 x 110 x h 75	10	0,69	150	160	○ ■ 4.550 ○ ■ 4.560
					○○ ■ 4.670 ○○ ■ 4.680
					○○○ ■ 4.690 ○○○ ■ 4.700

260 x 110 x h 75	10	0,71	150	169	○ ■ 5.100 ○ ■ 5.110
					○○ ■ 5.230 ○○ ■ 5.240
					○○○ ■ 5.250 ○○○ ■ 5.260

280 x 110 x h 75	10	0,74	150	177	○ ■ 5.210 ○ ■ 5.220
					○○ ■ 5.340 ○○ ■ 5.350
					○○○ ■ 5.360 ○○○ ■ 5.370

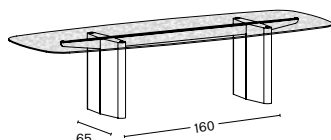

300 x 120 x h 75	10	0,80	150	198	○ ■ 5.450 ○ ■ 5.460
					○○ ■ 5.580 ○○ ■ 5.590
					○○○ ■ 5.600 ○○○ ■ 5.610

320 x 120 x h 75	10	0,81	150	202	○ ■ 5.580 ○ ■ 5.590
					○○ ■ 5.710 ○○ ■ 5.720
					○○○ ■ 5.730 ○○○ ■ 5.740

- Vetro fuso fumé / smoked fused glass / geschmolzenes Rauchglas / verre en fusion fumé
- Vetro fuso bronzo / bronze fused glass / geschmolzenes Bronze Glas / verre en fusion bronze

- basamento **nero grafite** / base **graphite black** / Gestell **Grafitsschwarz** / piètement **noir graphite**
- basamento **Dark Brown** / base **Dark Brown** / Gestell **Dark Brown** / piètement **Dark Brown**
- basamento **Champagne, Bronzo o Titanio** / base **Champagne, Bronzo or Titanio**
Gestell **Champagnerfarbe, Bronzo oder Titanio** / piètement **Champagne, Bronzo ou Titanio**

**Specificare sempre la finitura del basamento verniciato / always specify finish of laquered base
immer Ausführung des lackierten Gestell angeben / spécifier toujours finition du piètement laqué.**

- Tavolo con basamento centrale in metallo. Finiture: Bronzo, Titanio, Champagne, Dark Brown e nero grafite.
Top in appoggio sagomati in vetro fuso fumé o bronzo.
- Table with central base in metal. Finishes: Bronzo, Titanio, Champagne, Dark Drown and graphite black lacquered.
Shaped tops in fused smoked or bronze glass.
- Tisch mit zentralem Gestell aus Metall. Ausführungen: Bronzo, Titanio, Champagne, Dark Brown und Grafitsschwarz lackiert.
Top aus geschmolzenem profiliertem Rauchglas oder Bronze Glas.
- Table avec base central en métal. Finitions: Bronzo, Titanio, Champagne, Dark Brown et lacqué noir graphite.
Plateaux profilés en verre en fusion fumé ou bronze.

	I	dimensioni	spessore	volume	carico ammesso	peso	prezzo
	E	dimension	thickness	volume	admitted load	weight	price
	D	abmessungen	stärke	volumen	tragfähigkeit	gewicht	preis
	F	dimension	épaisseur	volume	charge admise	poids	prix
		cm	mm	m3	kg	kg	euro

T5

design Giulio Mancini 2018/2024

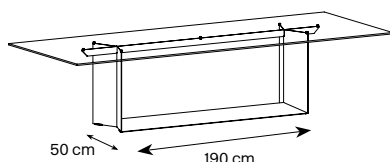
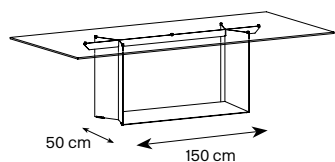
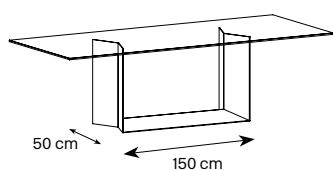
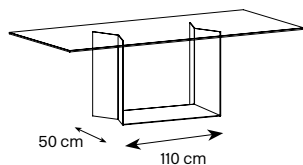

200 x 100 x h 75	10	0,70	150	112	○ □ 2.750 ■ 2.880 ■ 2.890 ○○ □ 3.740 ■ 3.870 ■ 3.880 ○○○ □ 3.450 ■ 3.580 ■ 3.590
220 x 100 x h 75	10	0,72	150	125	○ □ 2.830 ■ 2.960 ■ 2.970 ○○ □ 3.820 ■ 3.950 ■ 3.960 ○○○ □ 3.530 ■ 3.660 ■ 3.670
240 x 100 x h 75	10	0,92	150	130	○ □ 3.060 ■ 3.200 ■ 3.210 ○○ □ 4.050 ■ 4.190 ■ 4.200 ○○○ □ 3.760 ■ 3.900 ■ 3.910
260 x 100 x h 75	10	0,94	150	154	○ □ 3.430 ■ 3.580 ■ 3.590 ○○ □ 4.420 ■ 4.570 ■ 4.580 ○○○ □ 4.130 ■ 4.280 ■ 4.290
280 x 100 x h 75	10	0,96	150	157	○ □ 3.900 ■ 4.060 ■ 4.070 ○○ □ 4.890 ■ 5.050 ■ 5.060 ○○○ □ 4.600 ■ 4.760 ■ 4.770
300 x 100 x h 75	10	0,98	150	171	○ □ 3.990 ■ 4.160 ■ 4.170 ○○ □ 5.290 ■ 5.460 ■ 5.470 ○○○ □ 4.910 ■ 5.080 ■ 5.040
320 x 120 x h 75	10	1,16	150	179	○ □ 4.180 ■ 4.360 ■ 4.370 ○○ □ 5.480 ■ 5.660 ■ 5.670 ○○○ □ 5.100 ■ 5.280 ■ 5.290

- Vetro extrachiaro / extra clear glass / extrahelles Glas / verre extra clair
- Vetro fumé / smoked glass / Rauchglas / verre fumé
- Vetro bronzo / bronze glass / Bronze Glas / Verre bronze

- basamento **nero grafite o bianco opaco** / base **graphite black or matt white**
Gestell **Grafitschwarz oder matt weiß** / piètement **noir graphite ou mat blanc**
- basamento **Bronzo o Titanio** / base **Bronzo or Titanio**
Gestell **Bronzo oder Titanio** / piètement **Bronzo ou Titanio**
- basamento **Champagne o Dark Brown** / base **Champagne or Dark Brown**
Gestell **Champagnerfarbe oder Dark Brown** / piètement **Champagne ou Dark Brown**

**Specificare sempre la finitura del basamento verniciato / always specify finish of laquered base
immer Ausführung des lackierten Gestell angeben / spécifier toujours finition du piètement laqué.**

- Tavolo con basamento centrale in metallo. Finiture: Bronzo, Titanio, Champagne, Dark Brown e verniciato nero grafite o bianco opaco. Top in appoggio rettangolari o sagomati in vetro extrachiaro, fumé o bronzo.
- Table with central base in metal. Finishes: Bronzo, Titanio, Champagne, Dark Brown and graphite black or matt white lacquered. Rectangular or shaped tops in extra clear, smoked or bronze glass.
- Tisch mit zentralem Gestell aus Metall. Ausführungen: Bronzo, Titanio, Champagne, Dark Brown und Grafitschwarz oder matt weiß lackiert. Aufsitztop rechteckig oder profiliert aus extrahellem, Rauch oder Bronze Glas.
- Table avec base central en métal. Finitions: Bronzo, Titanio, Champagne, Dark Brown et laqué noir graphite ou mat blanc. Plateaux rectangulaires ou profilés en verre extra clair, fumé ou bronze.

	I	dimensioni	spessore	volume	carico ammesso	peso	prezzo
	E	dimension	thickness	volume	admitted load	weight	price
	D	abmessungen	stärke	volumen	tragfähigkeit	gewicht	preis
	F	dimension	épaisseur	volume	charge admise	poids	prix
		cm	mm	m3	kg	kg	euro

T5

design Giulio Mancini 2018/2024

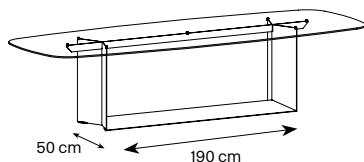
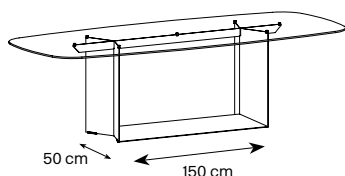
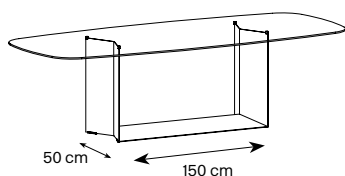
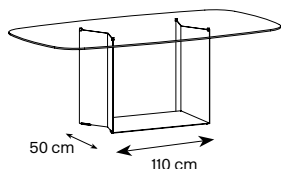

200 x 100 x h 75	10	0,71	150	110	○ □ 2.890 ■ 3.020 ■ 3.030 ○○ □ 3.880 ■ 4.010 ■ 4.020 ○○○ □ 3.590 ■ 3.720 ■ 3.730
220 x 100 x h 75	10	0,74	150	121	○ □ 2.970 ■ 3.100 ■ 3.110 ○○ □ 3.960 ■ 4.090 ■ 4.100 ○○○ □ 3.670 ■ 3.800 ■ 3.810
240 x 100 x h 75	10	0,94	150	129	○ □ 3.200 ■ 3.340 ■ 3.350 ○○ □ 4.190 ■ 4.330 ■ 4.340 ○○○ □ 3.900 ■ 4.040 ■ 4.050
260 x 110 x h 75	10	0,96	150	152	○ □ 3.570 ■ 3.720 ■ 3.730 ○○ □ 4.560 ■ 4.710 ■ 4.720 ○○○ □ 4.270 ■ 4.420 ■ 4.430
280 x 110 x h 75	10	0,97	150	167	○ □ 4.040 ■ 4.200 ■ 4.210 ○○ □ 5.030 ■ 5.190 ■ 5.200 ○○○ □ 4.740 ■ 4.900 ■ 4.910
300 x 120 x h 75	10	1,19	150	175	○ □ 4.130 ■ 4.300 ■ 4.310 ○○ □ 5.430 ■ 5.600 ■ 5.610 ○○○ □ 5.050 ■ 5.220 ■ 5.230
320 x 120 x h 75	10	1,22	150	205	○ □ 4.320 ■ 4.500 ■ 4.510 ○○ □ 5.620 ■ 5.800 ■ 5.810 ○○○ □ 5.240 ■ 5.420 ■ 5.430

- Vetro extrachiaro / extra clear glass / extrahelles Glas / verre extra clair
- Vetro fumé / smoked glass / Rauchglas / verre fumé
- Vetro bronzo / bronze glass / Bronze Glas / Verre bronze

- basamento **nero grafite o bianco opaco** / base **graphite black or matt white**
Gestell **Grafitschwarz oder matt weiß** / piètement **noir graphite ou mat blanc**
- basamento **Bronzo o Titanio** / base **Bronzo or Titanio**
Gestell **Bronzo oder Titanio** / piètement **Bronzo ou Titanio**
- basamento **Champagne o Dark Brown** / base **Champagne or Dark Brown**
Gestell **Champagnerfarbe oder Dark Brown** / piètement **Champagne ou Dark Brown**

**Specificare sempre la finitura del basamento verniciato / always specify finish of laquered base
immer Ausführung des lackierten Gestell angeben / spécifier toujours finition du piètement laqué.**

- Tavolo con basamento centrale in metallo. Finiture: Bronzo, Titanio, Champagne, Dark Brown e verniciato nero grafite o bianco opaco. Top in appoggio rettangolari o sagomati in vetro extrachiaro, fumé o bronzo.
- Table with central base in metal. Finishes: Bronzo, Titanio, Champagne, Dark Brown and graphite black or matt white lacquered. Rectangular or shaped tops in extra clear, smoked or bronze glass.
- Tisch mit zentralem Gestell aus Metall. Ausführungen: Bronzo, Titanio, Champagne, Dark Brown und Grafitschwarz oder matt weiß lackiert. Aufsitztop rechteckig oder profiliert aus extrahellem, Rauch oder Bronze Glas.
- Table avec base central en métal. Finitions: Bronzo, Titanio, Champagne, Dark Brown et lacqué noir graphite ou mat blanc. Plateaux rectangulaires ou profilés en verre extra clair, fumé ou bronze.

	I	dimensioni	spessore	volumi	carico ammesso	peso		prezzo
	E	dimension	thickness	volumi	admitted load	weight		price
	D	abmessungen	stärke	volumen	tragfähigkeit	gewicht		preis
	F	dimension	épaisseur	volumi	charge admise	poids		prix
		cm	mm	m3	kg	kg		euro

T5 fused glass

design Giulio Mancini 2023

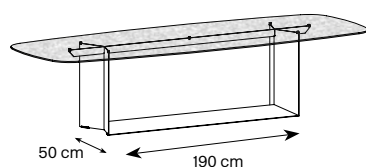
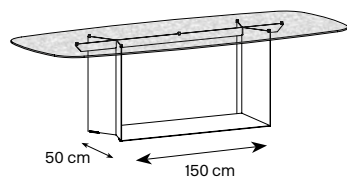
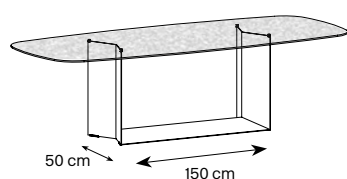
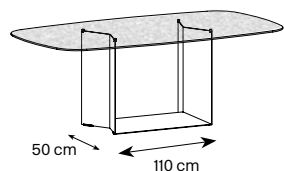

200 x 110 x h 75	10	0,71	150	110	○ ■ 3.610 ○ ■ 3.600 ○○ ■ 4.600 ○○ ■ 4.590 ○○○ ■ 4.310 ○○○ ■ 4.300
220 x 110 x h 75	10	0,74	150	121	○ ■ 3.740 ○ ■ 3.730 ○○ ■ 4.730 ○○ ■ 4.720 ○○○ ■ 4.440 ○○○ ■ 4.430
240 x 110 x h 75	10	0,94	150	129	○ ■ 3.980 ○ ■ 3.970 ○○ ■ 4.970 ○○ ■ 4.960 ○○○ ■ 4.680 ○○○ ■ 4.670
260 x 110 x h 75	10	0,96	150	152	○ ■ 4.680 ○ ■ 4.670 ○○ ■ 5.670 ○○ ■ 5.660 ○○○ ■ 5.380 ○○○ ■ 5.370
280 x 110 x h 75	10	0,97	150	167	○ ■ 4.740 ○ ■ 4.730 ○○ ■ 5.730 ○○ ■ 5.720 ○○○ ■ 5.440 ○○○ ■ 5.430
300 x 110 x h 75	10	1,19	150	175	○ ■ 4.830 ○ ■ 4.820 ○○ ■ 6.130 ○○ ■ 6.120 ○○○ ■ 5.750 ○○○ ■ 5.740
320 x 120 x h 75	10	1,22	150	205	○ ■ 5.010 ○ ■ 5.000 ○○ ■ 6.310 ○○ ■ 6.300 ○○○ ■ 5.930 ○○○ ■ 5.920

- Vetro fuso fumé / smoked fused glass / geschmolzenes Rauchglas / verre en fusion fumé
- Vetro fuso bronzo / bronze fused glass / geschmolzenes Bronze Glas / verre en fusion bronze

- basamento **nero grafite o bianco opaco** / base **graphite black or matt white**
Gestell **Grafit schwarz oder matt weiß** / piètement **noir graphite ou mat blanc**
- basamento **Bronzo o Titanio** / base **Bronzo or Titanio**
Gestell **Bronzo oder Titanio** / piètement **Bronzo ou Titanio**
- basamento **Champagne o Dark Brown** / base **Champagne or Dark Brown**
Gestell **Champagnerfarbe oder Dark Brown** / piètement **Champagne ou Dark Brown**

**Specificare sempre la finitura del basamento verniciato / always specify finish of laquered base
immer Ausführung des lackierten Gestell angeben / spécifier toujours finition du piètement laqué.**

- Tavolo con basamento centrale in metallo. Finiture: Bronzo, Titanio, Champagne, Dark Brown e verniciato nero grafite o bianco opaco. Top in appoggio in vetro fuso fumé o bronzo.
- Table with central base in metal. Finishes: Bronzo, Titanio, Champagne, Dark Brown and graphite black or matt white lacquered. Tops in fused smoked or bronze glass.
- Esstisch mit zentralem Gestell aus Metall. Ausführungen: Bronzo, Titanio, Champagne, Dark Brown und Grafit schwarz oder matt weiß lackiert. Top aus geschmolzenem Rauchglas oder Bronze Glas.
- Table avec base central en métal. Finitions: Bronzo, Titanio, Champagne, Dark Brown et laqué noir graphite ou mat blanc. Top en verre en fusion fumé ou bronze.

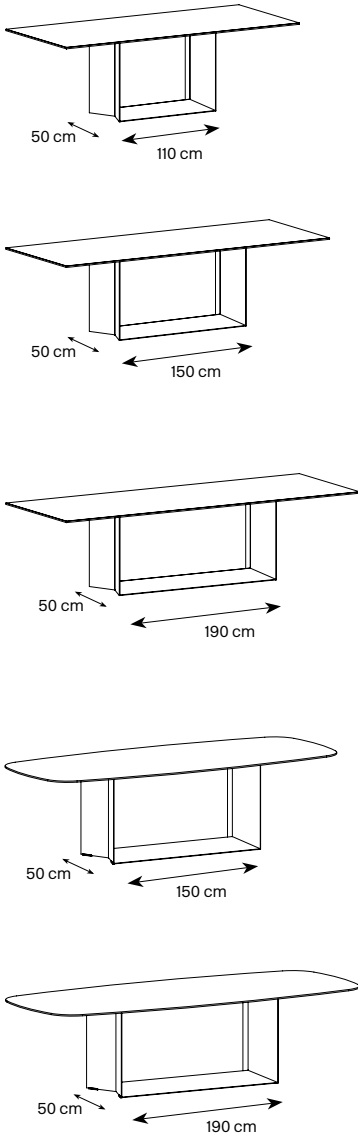
	I E D F	dimensioni dimension abmessungen dimension	spessore thickness stärke épaisseur	volum volume volumen volume	carico ammesso admitted load tragfähigkeit charge admise	peso weight gewicht poids	prezzo price preis prix
		cm	mm	m3	kg	kg	euro
T5 ceramic design Giulio Mancini 2018 		200 x 100 x h 75	8 + 5	0,70	150	128	○ 3.830 ○○ 4.820 ○○○ 4.530
		220 x 100 x h 75	8 + 5	0,71	150	136	○ 3.990 ○○ 4.980 ○○○ 4.690
		240 x 100 x h 75	8 + 5	0,85	150	152	○ 4.490 ○○ 5.480 ○○○ 5.190
		260 x 100 x h 75	8 + 5	0,94	150	163	○ 4.660 ○○ 5.650 ○○○ 5.360
		300 x 100 x h 75	10 + 5	1,16	150	192	○ 5.250 ○○ 6.550 ○○○ 6.170
		320 x 120 x h 75	10 + 5	1,25	150	242	○ 6.090 ○○ 7.390 ○○○ 7.010
		240 x 115 x h 75	8 + 5	0,95	150	170	○ 4.900 ○○ 5.890 ○○○ 5.600
		280 x 115 x h 75	8 + 5	0,98	150	188	○ 5.310 ○○ 6.300 ○○○ 6.010
		320 x 115 x h 75	10 + 5	1,20	150	218	○ 5.970 ○○ 7.270 ○○○ 6.890

- basamento **nero grafite o bianco opaco** / base **graphite black or matt white**
Gestell **Grafitschwarz oder matt weiß** / piètement **noir graphite ou mat blanc**
- basamento **Bronzo o Titanio** / base **Bronzo or Titanio**
Gestell **Bronzo oder Titanio** / piètement **Bronzo ou Titanio**
- basamento **Champagne o Dark Brown** / base **Champagne or Dark Brown**
Gestell **Champagnerfarbe oder Dark Brown** / piètement **Champagne ou Dark Brown**

**Specificare sempre la finitura del basamento verniciato / always specify finish of laquered base
immer Ausführung des lackierten Gestell angeben / spécifier toujours finition du piètement laqué.**

- Tavolo con basamento centrale in metallo. Finiture: Bronzo, Titanio, Champagne, Dark Brown e verniciato nero grafite o bianco opaco. Top in appoggio in ceramica nelle finiture: **Pietra di Savoia antracite bocciardato, Noir desir lucido o opaco, Calacatta oro venato lucido, Pietra Grey opaco, Sahara noir lucido o bocciardato o Travertino.**
- Table with central base in metal. Finishes: Bronzo, Titanio, Champagne, Dark Brown and graphite black or matt white lacquered. Ceramic top in following finishes: **Pietra di Savoia anthracite bushhammered, Noir desir polished or matt, Calacatta oro venato polished, Pietra Grey matt, Sahara noir polished or bushhammered or Travertino.**
- Esstisch mit zentralem Gestell aus Metall. Ausführungen: Bronzo, Titanio, Champagne, Dark Brown und Grafitschwarz oder matt weiß lackiert. Keramiktop in folgenden Ausführungen: **Pietra di Savoia Anthrazit bocciardato, Noir desir glänzend oder matt, Calacatta oro venato glänzend, Pietra Grey matt, Sahara noir glänzend oder bocciardato oder Travertino.**
- Table avec base central en métal. Finitions: Bronzo, Titanio, Champagne, Dark Brown et lacqué noir graphite ou mat blanc. Top en céramique disponible en: **Pietra di Savoia anthracite bouchardé, Noir desir brillant ou mat, Calacatta oro venato brillant, Pietra Grey mat, Sahar noir brillant ou bouchardé ou Travertino.**

T5 Stone

design Giulio Mancini 2025

dimensioni
dimension
dimensionen

spessore
thickness
stärke
épaisseur

volum
volume
volumen
volumen

carico ammesso
admitted load
tragfähigkeit
charge admise

peso
weight
gewicht
poids

prezzo
price
preis
prix

	cm	mm	m3	kg	kg	euro																											
	200 x 100 x h.75	20	0,70	150	222	Finiture top marmo / marble top finishes Marmortop Ausführungen / top marbre finitions																											
						<table border="1"> <tr> <th>N.Marquina Bianco Carrara</th> <th>Sahara Noir</th> <th>Travertino Romano</th> <th>Arabescato Orobico Gold</th> <th>Tropikal Storm</th> <th>Domus White</th> </tr> <tr> <td>○</td> <td>6.640</td> <td>7.540</td> <td>8.920</td> <td>10.730</td> <td>11.320</td> <td>11.880</td> </tr> <tr> <td>○○</td> <td>7.590</td> <td>8.490</td> <td>9.870</td> <td>11.680</td> <td>12.270</td> <td>12.830</td> </tr> <tr> <td>○○○</td> <td>7.330</td> <td>8.230</td> <td>9.610</td> <td>11.420</td> <td>12.010</td> <td>12.570</td> </tr> </table>	N.Marquina Bianco Carrara	Sahara Noir	Travertino Romano	Arabescato Orobico Gold	Tropikal Storm	Domus White	○	6.640	7.540	8.920	10.730	11.320	11.880	○○	7.590	8.490	9.870	11.680	12.270	12.830	○○○	7.330	8.230	9.610	11.420	12.010	12.570
						N.Marquina Bianco Carrara	Sahara Noir	Travertino Romano	Arabescato Orobico Gold	Tropikal Storm	Domus White																						
						○	6.640	7.540	8.920	10.730	11.320	11.880																					
○○	7.590	8.490	9.870	11.680	12.270	12.830																											
○○○	7.330	8.230	9.610	11.420	12.010	12.570																											
Finiture top marmo / marble top finishes Marmortop Ausführungen / top marbre finitions																																	
<table border="1"> <tr> <th>N.Marquina Bianco Carrara</th> <th>Sahara Noir</th> <th>Travertino Romano</th> <th>Arabescato Orobico Gold</th> <th>Tropikal Storm</th> <th>Domus White</th> </tr> <tr> <td>○</td> <td>7.640</td> <td>8.740</td> <td>10.540</td> <td>12.330</td> <td>13.130</td> <td>13.820</td> </tr> <tr> <td>○○</td> <td>8.640</td> <td>9.740</td> <td>11.540</td> <td>13.330</td> <td>14.130</td> <td>14.820</td> </tr> <tr> <td>○○○</td> <td>8.360</td> <td>9.460</td> <td>11.260</td> <td>13.050</td> <td>13.850</td> <td>14.540</td> </tr> </table>	N.Marquina Bianco Carrara	Sahara Noir	Travertino Romano	Arabescato Orobico Gold	Tropikal Storm	Domus White	○	7.640	8.740	10.540	12.330	13.130	13.820	○○	8.640	9.740	11.540	13.330	14.130	14.820	○○○	8.360	9.460	11.260	13.050	13.850	14.540						
N.Marquina Bianco Carrara	Sahara Noir	Travertino Romano	Arabescato Orobico Gold	Tropikal Storm	Domus White																												
○	7.640	8.740	10.540	12.330	13.130	13.820																											
○○	8.640	9.740	11.540	13.330	14.130	14.820																											
○○○	8.360	9.460	11.260	13.050	13.850	14.540																											
	240 x 100 x h.75	20	0,92	150	262	Finiture top marmo / marble top finishes Marmortop Ausführungen / top marbre finitions																											
						<table border="1"> <tr> <th>N.Marquina Bianco Carrara</th> <th>Sahara Noir</th> <th>Travertino Romano</th> <th>Arabescato Orobico Gold</th> <th>Tropikal Storm</th> <th>Domus White</th> </tr> <tr> <td>○</td> <td>7.640</td> <td>8.740</td> <td>10.540</td> <td>12.330</td> <td>13.130</td> <td>13.820</td> </tr> <tr> <td>○○</td> <td>8.640</td> <td>9.740</td> <td>11.540</td> <td>13.330</td> <td>14.130</td> <td>14.820</td> </tr> <tr> <td>○○○</td> <td>8.360</td> <td>9.460</td> <td>11.260</td> <td>13.050</td> <td>13.850</td> <td>14.540</td> </tr> </table>	N.Marquina Bianco Carrara	Sahara Noir	Travertino Romano	Arabescato Orobico Gold	Tropikal Storm	Domus White	○	7.640	8.740	10.540	12.330	13.130	13.820	○○	8.640	9.740	11.540	13.330	14.130	14.820	○○○	8.360	9.460	11.260	13.050	13.850	14.540
						N.Marquina Bianco Carrara	Sahara Noir	Travertino Romano	Arabescato Orobico Gold	Tropikal Storm	Domus White																						
						○	7.640	8.740	10.540	12.330	13.130	13.820																					
○○	8.640	9.740	11.540	13.330	14.130	14.820																											
○○○	8.360	9.460	11.260	13.050	13.850	14.540																											
Finiture top marmo / marble top finishes Marmortop Ausführungen / top marbre finitions																																	
<table border="1"> <tr> <th>N.Marquina Bianco Carrara</th> <th>Sahara Noir</th> <th>Travertino Romano</th> <th>Arabescato Orobico Gold</th> <th>Tropikal Storm</th> <th>Domus White</th> </tr> <tr> <td>○</td> <td>7.820</td> <td>8.990</td> <td>10.870</td> <td>12.720</td> <td>13.560</td> <td>14.290</td> </tr> <tr> <td>○○</td> <td>8.820</td> <td>9.990</td> <td>11.870</td> <td>13.720</td> <td>14.560</td> <td>15.290</td> </tr> <tr> <td>○○○</td> <td>8.540</td> <td>9.710</td> <td>11.590</td> <td>13.440</td> <td>14.280</td> <td>15.010</td> </tr> </table>	N.Marquina Bianco Carrara	Sahara Noir	Travertino Romano	Arabescato Orobico Gold	Tropikal Storm	Domus White	○	7.820	8.990	10.870	12.720	13.560	14.290	○○	8.820	9.990	11.870	13.720	14.560	15.290	○○○	8.540	9.710	11.590	13.440	14.280	15.010						
N.Marquina Bianco Carrara	Sahara Noir	Travertino Romano	Arabescato Orobico Gold	Tropikal Storm	Domus White																												
○	7.820	8.990	10.870	12.720	13.560	14.290																											
○○	8.820	9.990	11.870	13.720	14.560	15.290																											
○○○	8.540	9.710	11.590	13.440	14.280	15.010																											
	260 x 100 x h.75	20	0,96	150	278	Finiture top marmo / marble top finishes Marmortop Ausführungen / top marbre finitions																											
						<table border="1"> <tr> <th>N.Marquina Bianco Carrara</th> <th>Sahara Noir</th> <th>Travertino Romano</th> <th>Arabescato Orobico Gold</th> <th>Tropikal Storm</th> <th>Domus White</th> </tr> <tr> <td>○</td> <td>9.140</td> <td>11.030</td> <td>13.090</td> <td>14.770</td> <td>15.910</td> <td>16.800</td> </tr> <tr> <td>○○</td> <td>10.140</td> <td>12.030</td> <td>14.090</td> <td>15.770</td> <td>16.910</td> <td>17.800</td> </tr> <tr> <td>○○○</td> <td>9.860</td> <td>11.750</td> <td>13.810</td> <td>15.490</td> <td>16.630</td> <td>17.520</td> </tr> </table>	N.Marquina Bianco Carrara	Sahara Noir	Travertino Romano	Arabescato Orobico Gold	Tropikal Storm	Domus White	○	9.140	11.030	13.090	14.770	15.910	16.800	○○	10.140	12.030	14.090	15.770	16.910	17.800	○○○	9.860	11.750	13.810	15.490	16.630	17.520
						N.Marquina Bianco Carrara	Sahara Noir	Travertino Romano	Arabescato Orobico Gold	Tropikal Storm	Domus White																						
						○	9.140	11.030	13.090	14.770	15.910	16.800																					
○○	10.140	12.030	14.090	15.770	16.910	17.800																											
○○○	9.860	11.750	13.810	15.490	16.630	17.520																											
Finiture top marmo / marble top finishes Marmortop Ausführungen / top marbre finitions																																	
<table border="1"> <tr> <th>N.Marquina Bianco Carrara</th> <th>Sahara Noir</th> <th>Travertino Romano</th> <th>Arabescato Orobico Gold</th> <th>Tropikal Storm</th> <th>Domus White</th> </tr> <tr> <td>○</td> <td>9.140</td> <td>11.030</td> <td>13.090</td> <td>14.770</td> <td>15.910</td> <td>16.800</td> </tr> <tr> <td>○○</td> <td>10.140</td> <td>12.030</td> <td>14.090</td> <td>15.770</td> <td>16.910</td> <td>17.800</td> </tr> <tr> <td>○○○</td> <td>9.860</td> <td>11.750</td> <td>13.810</td> <td>15.490</td> <td>16.630</td> <td>17.520</td> </tr> </table>	N.Marquina Bianco Carrara	Sahara Noir	Travertino Romano	Arabescato Orobico Gold	Tropikal Storm	Domus White	○	9.140	11.030	13.090	14.770	15.910	16.800	○○	10.140	12.030	14.090	15.770	16.910	17.800	○○○	9.860	11.750	13.810	15.490	16.630	17.520						
N.Marquina Bianco Carrara	Sahara Noir	Travertino Romano	Arabescato Orobico Gold	Tropikal Storm	Domus White																												
○	9.140	11.030	13.090	14.770	15.910	16.800																											
○○	10.140	12.030	14.090	15.770	16.910	17.800																											
○○○	9.860	11.750	13.810	15.490	16.630	17.520																											
	280 x 120 x h.75	20	1,10	150	306	Finiture top marmo / marble top finishes Marmortop Ausführungen / top marbre finitions																											
						<table border="1"> <tr> <th>N.Marquina Bianco Carrara</th> <th>Sahara Noir</th> <th>Travertino Romano</th> <th>Arabescato Orobico Gold</th> <th>Tropikal Storm</th> <th>Domus White</th> </tr> <tr> <td>○</td> <td>9.140</td> <td>11.030</td> <td>13.090</td> <td>14.770</td> <td>15.910</td> <td>16.800</td> </tr> <tr> <td>○○</td> <td>10.140</td> <td>12.030</td> <td>14.090</td> <td>15.770</td> <td>16.910</td> <td>17.800</td> </tr> <tr> <td>○○○</td> <td>9.860</td> <td>11.750</td> <td>13.810</td> <td>15.490</td> <td>16.630</td> <td>17.520</td> </tr> </table>	N.Marquina Bianco Carrara	Sahara Noir	Travertino Romano	Arabescato Orobico Gold	Tropikal Storm	Domus White	○	9.140	11.030	13.090	14.770	15.910	16.800	○○	10.140	12.030	14.090	15.770	16.910	17.800	○○○	9.860	11.750	13.810	15.490	16.630	17.520
						N.Marquina Bianco Carrara	Sahara Noir	Travertino Romano	Arabescato Orobico Gold	Tropikal Storm	Domus White																						
						○	9.140	11.030	13.090	14.770	15.910	16.800																					
○○	10.140	12.030	14.090	15.770	16.910	17.800																											
○○○	9.860	11.750	13.810	15.490	16.630	17.520																											
Finiture top marmo / marble top finishes Marmortop Ausführungen / top marbre finitions																																	
<table border="1"> <tr> <th>N.Marquina Bianco Carrara</th> <th>Sahara Noir</th> <th>Travertino Romano</th> <th>Arabescato Orobico Gold</th> <th>Tropikal Storm</th> <th>Domus White</th> </tr> <tr> <td>○</td> <td>9.140</td> <td>11.030</td> <td>13.090</td> <td>14.770</td> <td>15.910</td> <td>16.800</td> </tr> <tr> <td>○○</td> <td>10.140</td> <td>12.030</td> <td>14.090</td> <td>15.770</td> <td>16.910</td> <td>17.800</td> </tr> <tr> <td>○○○</td> <td>9.860</td> <td>11.750</td> <td>13.810</td> <td>15.490</td> <td>16.630</td> <td>17.520</td> </tr> </table>	N.Marquina Bianco Carrara	Sahara Noir	Travertino Romano	Arabescato Orobico Gold	Tropikal Storm	Domus White	○	9.140	11.030	13.090	14.770	15.910	16.800	○○	10.140	12.030	14.090	15.770	16.910	17.800	○○○	9.860	11.750	13.810	15.490	16.630	17.520						
N.Marquina Bianco Carrara	Sahara Noir	Travertino Romano	Arabescato Orobico Gold	Tropikal Storm	Domus White																												
○	9.140	11.030	13.090	14.770	15.910	16.800																											
○○	10.140	12.030	14.090	15.770	16.910	17.800																											
○○○	9.860	11.750	13.810	15.490	16.630	17.520																											

- basamento **nero grafite o bianco opaco** / base **graphite black or matt white**
Gestell **Grafit schwarz oder matt weiß** / piètement **noir graphite ou mat blanc**
- basamento **Bronzo o Titanio** / base **Bronzo or Titanio**
Gestell **Bronzo oder Titanio** / piètement **Bronzo ou Titanio**
- basamento **Champagne o Dark Brown** / base **Champagne or Dark Brown**
Gestell **Champagnerfarbe oder Dark Brown** / piètement **Champagne ou Dark Brown**

Specificare sempre la finitura del basamento verniciato
always specify finish of laquered base
immer Ausführung des lackierten Gestell angeben
spécifier toujours finition du piètement laqué.

- Tavolo con basamento centrale in metallo. Finiture: Bronzo, Titanio, Champagne, Dark Brown, verniciato nero graffite o bianco opaco.
Top in appoggio rettangolari o sagomati in marmo spazzolato opaco con bordo bisellato.
Finiture: **Nero Marquina, Bianco Carrara, Arabescato Orobico Gold, Sahara Noir, Tropikal Storm, Domus White e Travertino Romano.**
- Table with central base in metal. Finishes: Bronzo, Titanio, Champagne, Dark Brown, graphite black or matt white lacquered.
Rectangular or shaped tops in matt brushed marble with bevelled edge.
Finishes: **Nero Marquina, Bianco Carrara, Arabescato Orobico Gold, Sahara Noir, Tropikal Storm, Domus White and Travertino Romano.**
- Tisch mit zentralem Gestell aus Metall. Ausführungen: Bronzo, Titanio, Champagne, Dark Brown, Grafit schwarz oder matt weiß lackiert.
Aufsitztop rechteckig oder profiliert aus matt gebürstetem Marmor mit Facettenschliff am Rand.
Ausführungen: **Nero Marquina, Bianco Carrara, Arabescato Orobico Gold, Sahara Noir, Tropikal Storm, Domus White und Travertino Romano.**
- Table avec base central en métal. Finitions: Bronzo, Titanio, Champagne, Dark Brown, lacqué noir graphite ou mat blanc.
Top en appuis rectangulaire ou profilé en marble brossé matte avec bord biseauté.
Finitions: **Nero Marquina, Bianco Carrara, Arabescato Orobico Gold, Sahara Noir, Tropikal Storm, Domus White et Travertino Romano.**

T5 Stone

design Giulio Mancini 2025

dimensioni
dimension
dimensionen

spessore
thickness
stärke
épaisseur

volume
volumen
volumen

carico ammesso
admitted load
tragfähigkeit
charge admise

peso
weight
gewicht
poids

prezzo
price
preis
prix

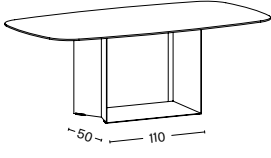
	cm	mm	m3	kg	kg	euro							
	200 x 115 x h.75	20	0,80	150	231	Finiture top marmo / marble top finishes Marmortop Ausführungen / top marbre finitions							
						N.Marquinia Bianco Carrara	Sahara Noir	Travertino Romano	Arabescato Orobico Gold	Tropikal Storm	Domus White		
						○	6.960	7.960	9.540	11.010	11.730	12.340	
						○○	7.910	8.920	10.480	11.960	12.680	13.290	
						○○○	7.650	8.650	10.230	11.700	12.420	13.030	
						Finiture top marmo / marble top finishes Marmortop Ausführungen / top marbre finitions							
	220 x 115 x h.75	20	0,88	150	248	248	N.Marquinia Bianco Carrara	Sahara Noir	Travertino Romano	Arabescato Orobico Gold	Tropikal Storm	Domus White	
							○	7.430	8.530	10.190	11.800	12.600	13.270
							○○	8.380	9.480	11.140	12.750	13.550	14.220
							○○○	8.120	9.220	10.880	12.490	13.290	13.960
							Finiture top marmo / marble top finishes Marmortop Ausführungen / top marbre finitions						
							240 x 120 x h.75	20	0,99	150	150	282	N.Marquinia Bianco Carrara
○	8.060	9.330	11.390	12.700	13.680	14.440							
○○	9.060	10.330	12.390	13.700	14.680	15.440							
○○○	8.780	10.050	12.110	13.420	14.400	15.160							
Finiture top marmo / marble top finishes Marmortop Ausführungen / top marbre finitions													
260 x 120 x h.75	20	1,13	150	150	299	N.Marquinia Bianco Carrara							Sahara Noir
						○	8.510	9.880	12.110	13.440	14.510	15.330	
						○○	9.510	10.880	13.110	14.440	15.510	16.330	
						○○○	9.230	10.600	12.830	14.160	15.230	16.050	
						Finiture top marmo / marble top finishes Marmortop Ausführungen / top marbre finitions							
						280 x 120 x h.75	20	1,15	150	150	316	N.Marquinia Bianco Carrara	Sahara Noir
○	8.950	10.410	12.810	14.170	15.320							16.200	
○○	9.950	11.410	13.810	15.170	16.320							17.200	
○○○	9.670	11.130	13.530	14.890	16.040							16.920	

- basamento **nero grafite o bianco opaco** / base **graphite black or matt white**
Gestell **Grafitschwarz oder matt weiß** / piètement **noir graphite ou mat blanc**
- basamento **Bronzo o Titanio** / base **Bronzo or Titanio**
Gestell **Bronzo oder Titanio** / piètement **Bronzo ou Titanio**
- basamento **Champagne o Dark Brown** / base **Champagne or Dark Brown**
Gestell **Champagnerfarbe oder Dark Brown** / piètement **Champagne ou Dark Brown**

Specificare sempre la finitura del basamento verniciato
always specify finish of laquered base
immer Ausführung des lackierten Gestell angeben
spécifier toujours finition du piètement laqué.

- Tavolo con basamento centrale in metallo. Finiture: Bronzo, Titanio, Champagne, Dark Brown, verniciato nero graffite o bianco opaco.
Top in appoggio rettangolari o sagomati in marmo spazzolato opaco con bordo bisellato.
Finiture: **Nero Marquina, Bianco Carrara, Arabescato Orobico Gold, Sahara Noir, Tropikal Storm, Domus White e Travertino Romano.**
- Table with central base in metal. Finishes: Bronzo, Titanio, Champagne, Dark Brown, graphite black or matt white lacquered.
Rectangular or shaped tops in matt brushed marble with bevelled edge.
Finishes: **Nero Marquina, Bianco Carrara, Arabescato Orobico Gold, Sahara Noir, Tropikal Storm, Domus White and Travertino Romano.**
- Tisch mit zentralem Gestell aus Metall. Ausführungen: Bronzo, Titanio, Champagne, Dark Brown, Grafitschwarz oder matt weiß lackiert.
Aufsitztop rechteckig oder profiliert aus matt gebürstetem Marmor mit Facettenschliff am Rand.
Ausführungen: **Nero Marquina, Bianco Carrara, Arabescato Orobico Gold, Sahara Noir, Tropikal Storm, Domus White und Travertino Romano.**
- Table avec base central en métal. Finitions: Bronzo, Titanio, Champagne, Dark Brown, lacqué noir graphite ou mat blanc.
Top en appuis rectangulaire ou profilé en marbre brossé matte avec bord biseauté.
Finitions: **Nero Marquina, Bianco Carrara, Arabescato Orobico Gold, Sahara Noir, Tropikal Storm, Domus White et Travertino Romano.**

	I E D F	dimensioni dimension abmessungen dimension	spessore thickness stärke épaisseur	volume volume volumen volume	carico ammesso admitted load tragfähigkeit charge admise	peso weight gewicht poids	prezzo price preis prix
		cm	mm	m3	kg	kg	euro

Thrim

design Massimo Castagna 2022

Ø140 x h 75	10 / 10	0,62	150	135	□ 3.290 ■ 3.560 ■ 3.580
Ø160 x h 75	10 / 10	0,7	150	169	□ 3.670 ■ 3.970 ■ 3.990
Ø180 x h 75	10 / 10	0,82	150	194	□ 4.170 ■ 4.540 ■ 4.580
Ø200 x h 75	10 / 10	0,94	150	213	□ 4.690 ■ 5.150 ■ 5.190

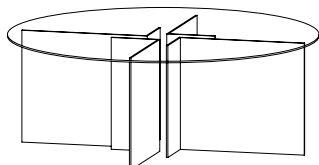

- basamento e piano extrachiaro / extra clear base and top
Gestell und Tischplatte extrahell / piètement et top extra clair
- basamento e piano fumè / smoked base and top
Gestell und Tischplatte aus Rauchglas / piètement et top fumé
- basamento e piano bronzo / bronze base and top
Gestell und Tischplatte aus Bronze Glas / piètement et top bronze

- Tavolo con piano in appoggio in vetro extra chiaro , fumè o bronzo temperato.
Basamento composto da elementi accostabili in vetro extra chiaro , fumè o bronzo.
- Dining table with top in tempered extra clear, smoked or bronze glass.
Base made of combining elements in extra clear, smoked or bronze glass.
- Esstisch mit Top aus Sicherheitsglas extrahell, Rauchglas oder Bronze Glas.
Gestell aus kombinierbaren Elementen aus extrahellem Glas, Rauchglas oder Bronze Glas.
- Table haut avec top en verre trempé en extra clair, fumé ou bronze.
Piètement composé de éléments approchables en verre extra clair, fumé ou bronze.

Thrim fused glass

design Massimo Castagna 2023

Ø140 x h 75	10 / 10	0,62	150	135	■ 4.350 ■ 4.370
Ø160 x h 75	10 / 10	0,7	150	169	■ 4.880 ■ 4.900
Ø180 x h 75	10 / 10	0,82	150	194	■ 5.770 ■ 5.810
Ø200 x h 75	10 / 10	0,94	150	213	■ 6.560 ■ 6.600

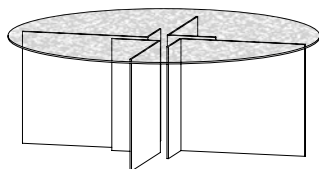

- basamento vetro fumè e piana vetro fuso fumè / base smoked glass and top fused smoked glass
Gestell Rauchglas und Top geschmolzenes Rauchglas / piètement verre fumé et top en verre en fusion fumé
- basamento vetro bronzo e piana vetro fuso bronzo / base bronze glass and top fused bronze glass
Gestell Bronze Glas und Top geschmolzenes Bronze Glas / piètement verre bronze et top verre en fusion bronze

- Tavolo con piano in appoggio in vetro fuso fumè o bronzo.
Basamento composto da elementi accostabili in vetro fumè o bronzo.
- Dining table with propped up top in fused smoked or bronze glass.
Base made of combining elements in smoked or bronze glass.
- Esstisch mit Auflage Top aus geschmolzenem Rauchglas oder Bronze Glas.
Gestell aus kombinierbaren Elementen aus Rauchglas oder Bronze Glas.
- Table haut avec top en appui en verre en fusion fumé ou bronze.
Piètement composé de éléments approchables en verre fumé ou bronze.

	I	dimensioni	spessore	volume	carico ammesso	peso	prezzo
	E	dimension	thickness	volume	admitted load	weight	price
	D	abmessungen	stärke	volumen	tragfähigkeit	gewicht	preis
	F	dimension	épaisseur	volume	charge admise	poids	prix
		cm	mm	m3	kg	kg	euro
Thrim design Massimo Castagna 2022		140 x 140 x h 75	10 / 10	0,87	150	186	□ 3.470 ■ 3.750 ■ 3.770
		160 x 160 x h 75	10 / 10	1,05	150	222	□ 3.860 ■ 4.190 ■ 4.220
		180 x 180 x h 75	10 / 10	1,22	150	259	□ 4.390 ■ 4.780 ■ 4.820
		200 x 200 x h 75	10 / 10	1,4	150	291	□ 4.940 ■ 5.420 ■ 5.460

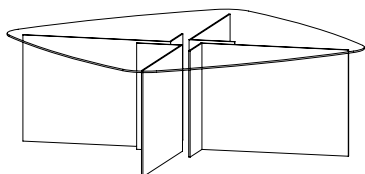

- basamento e piano extrachiaro / extra clear base and top
Gestell und Tischplatte extrahell / piètement et top extra clair
- basamento e piano fumè / smoked base and top
Gestell und Tischplatte aus Rauchglas / piètement et top fumé
- basamento e piano bronzo / bronze base and top
Gestell und Tischplatte aus Bronze Glas / piètement et top bronze

- Tavolo con piano in appoggio in vetro extra chiaro , fumè o bronzo temperato.
Basamento composto da elementi accostabili in vetro extra chiaro , fumè o bronzo.
- Dining table with top in tempered extra clear, smoked or bronze glass.
Base made of combining elements in extra clear, smoked or bronze glass.
- Esstisch mit Top aus Sicherheitsglas extrahell, Rauchglas oder Bronze Glas.
Gestell aus kombinierbaren Elementen aus extrahellem Glas, Rauchglas oder Bronze Glas.
- Table haut avec top en verre trempé en extra clair, fumé ou bronze.
Piètement composé de éléments approchables en verre extra clair, fumé ou bronze.

	I E D F	dimensioni dimension abmessungen dimension	spessore thickness stärke épaisseur	volume volume volumen volume	carico ammesso admitted load tragfähigkeit charge admise	peso weight gewicht poids	prezzo price preis prix
		cm	mm	m3	kg	kg	euro

Thrim design Massimo Castagna 2022	200 x 110 x h 75	10 / 10	0,93	150	169	□ 3.360 ■ 3.470 ■ 3.480
	220 x 110 x h 75	10 / 10	1,02	150	187	□ 3.550 ■ 3.660 ■ 3.670
	240 x 110 x h 75	10 / 10	1,06	150	195	□ 3.670 ■ 3.780 ■ 3.790
	260 x 110 x h 75	10 / 10	1,11	150	209	□ 3.800 ■ 3.920 ■ 3.930
	280 x 110 x h 75	10 / 10	1,14	150	217	□ 3.890 ■ 4.020 ■ 4.030
	300 x 120 x h 75	10 / 10	1,34	150	236	□ 4.180 ■ 4.300 ■ 4.310
	320 x 120 x h 75	10 / 10	1,50	150	255	□ 4.400 ■ 4.540 ■ 4.550

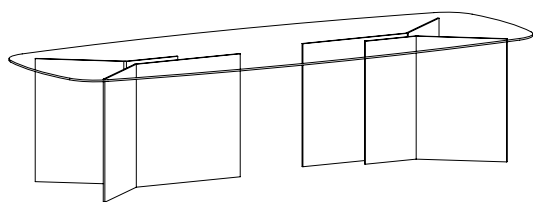

- basamento e piano extrachiaro / extra clear base and top
Gestell und Tischplatte extrahell / piètement et top extra clair
- basamento e piano fumè / smoked base and top
Gestell und Tischplatte aus Rauchglas / piètement et top fumé
- basamento e piano bronzo / bronze base and top
Gestell und Tischplatte aus Bronze Glas / piètement et top bronze

- Tavolo con piano in appoggio in vetro extra chiaro , fumè o bronzo temperato.
Basamento composto da elementi accostabili in vetro extra chiaro , fumè o bronzo.
- Dining table with top in tempered extra clear, smoked or bronze glass.
Base made of combining elements in extra clear, smoked or bronze glass.
- Esstisch mit Top aus Sicherheitsglas extrahell, Rauchglas oder Bronze Glas.
Gestell aus kombinierbaren Elementen aus extrahellem Glas, Rauchglas oder Bronze Glas.
- Table haut avec top en verre trempé en extra clair, fumé ou bronze.
Piètement composé de éléments approchables en verre extra clair, fumé ou bronze.

Thrim fused glass design Massimo Castagna 2023	200 x 110 x h 75	10 / 10	0,93	150	169	■ 4.130 ■ 4.140
	220 x 110 x h 75	10 / 10	1,02	150	187	■ 4.320 ■ 4.330
	240 x 110 x h 75	10 / 10	1,06	150	195	■ 4.450 ■ 4.460
	260 x 110 x h 75	10 / 10	1,11	150	209	■ 4.570 ■ 4.580
	280 x 110 x h 75	10 / 10	1,14	150	217	■ 4.760 ■ 4.770
	300 x 120 x h 75	10 / 10	1,34	150	236	■ 5.040 ■ 5.050
	320 x 120 x h 75	10 / 10	1,50	150	255	■ 5.160 ■ 5.170

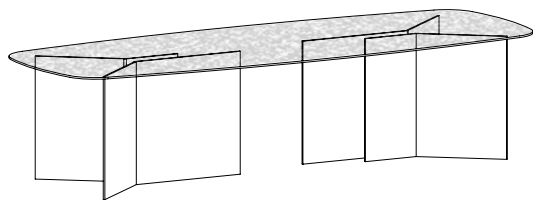

- basamento vetro fumè e piana vetro fuso fumè / base smoked glass and top fused smoked glass
Gestell Rauchglas und Top geschmolzenes Rauchglas / piètement verre fumé et top en verre en fusion fumé
- basamento vetro bronzo e piana vetro fuso bronzo / base bronze glass and top fused bronze glass
Gestell Bronze Glas und Top geschmolzenes Bronze Glas / piètement verre bronze et top verre en fusion bronze

- Tavolo con piano in appoggio in vetro fuso fumè o bronzo.
Basamento composto da elementi accostabili in vetro fumè o bronzo.
- Dining table with propped up top in fused smoked or bronze glass.
Base made of combining elements in smoked or bronze glass.
- Esstisch mit Auflage Top aus geschmolzenem Rauchglas oder Bronze Glas.
Gestell aus kombinierbaren Elementen aus Rauchglas oder Bronze Glas.
- Table haut avec top en appui en verre en fusion fumé ou bronze.
Piètement composé de éléments approchables en verre fumé ou bronze.

	I E D F	dimensioni dimension abmessungen dimension	spessore thickness stärke épaisseur	volume volume volumen volume	carico ammesso admitted load tragfähigkeit charge admise	peso weight gewicht poids	prezzo price preis prix
		cm	mm	m3	kg	kg	euro
Thrim design Massimo Castagna 2022		200 x 100 x h 75	10 / 10	0,91	150	170	□ 3.210 ■ 3.310 ■ 3.320
		220 x 100 x h 75	10 / 10	1,01	150	188	□ 3.370 ■ 3.480 ■ 3.490
		240 x 100 x h 75	10 / 10	1,04	150	196	□ 3.460 ■ 3.580 ■ 3.590
		260 x 100 x h 75	10 / 10	1,09	150	210	□ 3.620 ■ 3.730 ■ 3.740
		280 x 100 x h 75	10 / 10	1,11	150	218	□ 3.710 ■ 3.820 ■ 3.830
		300 x 100 x h 75	10 / 10	1,31	150	237	□ 3.980 ■ 4.110 ■ 4.120
		320 x 120 x h 75	10 / 10	1,70	150	271	□ 4.530 ■ 4.690 ■ 4.700

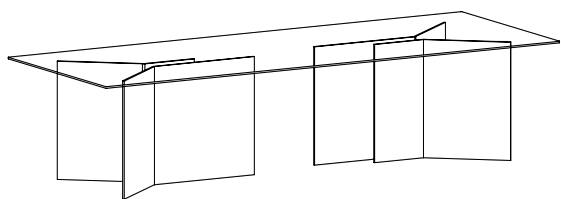

- basamento e piano extrachiaro / extra clear base and top
Gestell und Tischplatte extrahell / piètement et top extra clair
- basamento e piano fumè / smoked base and top
Gestell und Tischplatte aus Rauchglas / piètement et top fumé
- basamento e piano bronzo / bronze base and top
Gestell und Tischplatte aus Bronze Glas / piètement et top bronze

- Tavolo con piano in appoggio in vetro extra chiaro , fumè o bronzo temperato.
Basamento composto da elementi accostabili in vetro extra chiaro , fumè o bronzo.
- Dining table with top in tempered extra clear, smoked or bronze glass.
Base made of combining elements in extra clear, smoked or bronze glass.
- Esstisch mit Top aus Sicherheitsglas extrahell, Rauchglas oder Bronze Glas.
Gestell aus kombinierbaren Elementen aus extrahellem Glas, Rauchglas oder Bronze Glas.
- Table haut avec top en verre trempé en extra clair, fumé ou bronze.
Piètement composé de éléments approchables en verre extra clair, fumé ou bronze.

	I	dimensioni	spessore	volume	carico ammesso	peso	prezzo
	E	dimension	thickness	volume	admitted load	weight	price
	D	abmessungen	stärke	volumen	tragfähigkeit	gewicht	preis
	F	dimension	épaisseur	volume	charge admise	poids	prix
		cm	mm	m3	kg	kg	euro

Wiston

Tonelli design studio 2025

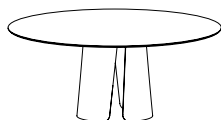

Ø120 x h 75	12	0,48	150	175	○	4.790
					○○	4.910
					○○○	4.930
Ø140 x h 75	12	0,54	150	192	○	5.060
					○○	5.180
					○○○	5.200
Ø160 x h 75	12	0,58	150	211	○	6.030
					○○	6.150
					○○○	6.170
Ø180 x h 75	12	0,7	150	232	○	6.820
					○○	6.940
					○○○	6.960

Maggiorazione per finitura laccato RAL opaco su base e top in vetro satinato
Surcharge for matt RAL lacquered finish on base and frosted glass top
Aufpreis für matt RAL Lackierung des Gestells und des Satiniertem Glastop
Supplément pour finition laquée mat RAL sur base et plateau en verre satiné

- basamento **nero grafite o bianco opaco** / base **graphite black or matt white**
Gestell **Grafit Schwarz oder matt weiß** / piètement **noir graphite ou mat blanc**
- basamento **Dark Brown** / base **Dark Brown**
Gestell **Dark Brown** / piètement **Dark Brown**
- basamento **Champagne, Titanio o Bronzo** / base **Champagne, Titanio or Bronzo**
Gestell **Champagnerfarbe, Titanio oder Bronzo** / piètement **Champagne, Titanio ou Bronzo**



Specificare sempre la finitura del basamento verniciato e del colore del top.
Always specify finish of laquered base and colour of top.
Immer Ausführung des lackierten Gestell angeben und Farbe des Tops.
Spécifier toujours finition du piètement laqué et couleur du top.

- Tavolo con basamento centrale in metallo. Finiture: nero grafite o bianco opaco, Dark Brown, Titanio, Champagne o Bronzo.
Top rotondo o sagomato con bordo bisellato in vetro extrachiaro satinato laccato nero, bianco, Dark Brown, Titanio, Champagne e Bronzo.
- Table with central base in metal. Finishes: graphite black or matt white, Dark Brown, Titanio, Champagne or Bronzo.
Round or shaped top with bevelled edge in extra clear frosted glass lacquered black, white, Dark Brown, Titanio, Champagne and Bronzo.
- Tisch mit zentralem Gestell aus Metall. Ausführungen: Grafit Schwarz oder matt weiß, Dark Brown, Titanio, Champagnerfarbe oder Bronzo.
Runder oder profilierter Top mit Facettenschliff aus extrahell satiniertem Glas schwarz, weiß, Dark Brown, Titanio, Champagne und Bronzo lackiert.
- Table avec base central en métal. Finitions: noir graphite ou blanc mat, Dark Brown, Titanio, Champagne ou Bronzo.
Top ronde ou profilé avec bord biseauté en verre extra clair satiné lacqué noir, blanc, Dark Brown, Titanio, Champagne et Bronzo.

	I E D F	dimensioni dimension abmessungen dimension	spessore thickness stärke épaisseur	volume volume volumen volume	carico ammesso admitted load tragfähigkeit charge admise	peso weight gewicht poids	prezzo price preis prix
		cm	mm	m3	kg	kg	euro

Wiston

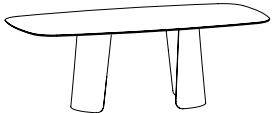
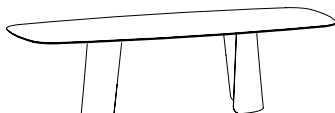
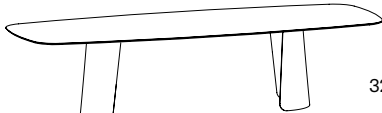
Tonelli design studio 2025

	200 x 110 x h 75	12	0,57	150	213	○	5.910
						○○	6.030
						○○○	6.050
	220 x 110 x h 75	12	0,6	150	221	○	6.140
						○○	6.260
						○○○	6.280
	240 x 110 x h 75	12	0,63	150	245	○	6.560
						○○	6.680
						○○○	6.700
	260 x 110 x h 75	12	0,65	150	252	○	6.910
						○○	7.030
						○○○	7.050
	280 x 110 x h 75	12	0,69	150	261	○	6.960
						○○	7.080
						○○○	7.100
	300 x 120 x h 75	12	0,72	150	285	○	7.640
						○○	7.760
						○○○	7.780
	320 x 120 x h 75	12	0,79	150	303	○	8.200
						○○	8.320
						○○○	8.340

Maggiorazione per finitura laccato RAL opaco su base e top in vetro satinato
Surcharge for matt RAL lacquered finish on base and frosted glass top
Aufpreis für matt RAL Lackierung des Gestells und des Satiniertem Glastop
Supplément pour finition laquée mat RAL sur base et plateau en verre satiné

- basamento **nero grafite o bianco opaco** / base **graphite black or matt white**
Gestell **Grafitschwarz oder matt weiß** / piètement **noir graphite ou mat blanc**
- basamento **Dark Brown** / base **Dark Brown**
Gestell **Dark Brown** / piètement **Dark Brown**
- basamento **Champagne, Titanio o Bronzo** / base **Champagne, Titanio or Bronzo**
Gestell **Champagnerfarbe, Titanio oder Bronzo** / piètement **Champagne, Titanio ou Bronzo**

Specificare sempre la finitura del basamento verniciato e del colore del top.
Always specify finish of laquered base and colour of top.
Immer Ausführung des lackierten Gestell angeben und Farbe des Tops.
Spécifier toujours finition du piètement laqué et couleur du top.

- Tavolo con basamento centrale in metallo. Finiture: nero grafite o bianco opaco, Dark Brown, Titanio, Champagne o Bronzo.
Top rotondo o sagomato con bordo bisellato in vetro extrachiaro satinato laccato nero, bianco, Dark Brown, Titanio, Champagne e Bronzo.
- Table with central base in metal. Finishes: graphite black or matt white, Dark Brown, Titanio, Champagne or Bronzo.
Round or shaped top with bevelled edge in extra clear frosted glass lacquered black, white, Dark Brown, Titanio, Champagne and Bronzo.
- Tisch mit zentralem Gestell aus Metall. Ausführungen: Grafitschwarz oder matt weiß, Dark Brown, Titanio, Champagnerfarbe oder Bronzo.
Runder oder profilierter Top mit Facettenschliff aus extrahell satiniertem Glas schwarz, weiß, Dark Brown, Titanio, Champagne und Bronzo lackiert.
- Table avec base central en métal. Finitions: noir graphite ou blanc mat, Dark Brown, Titanio, Champagne ou Bronzo.
Top ronde ou profilé avec bord biseauté en verre extra clair satiné lacqué noir, blanc, Dark Brown, Titanio, Champagne et Bronzo.

	I	dimensioni	spessore	volume	carico ammesso	peso	prezzo
	E	dimension	thickness	volume	admitted load	weight	price
	D	abmessungen	stärke	volumen	tragfähigkeit	gewicht	preis
	F	dimension	épaisseur	volume	charge admise	poids	prix
		cm	mm	m3	kg	kg	euro

Wiston ceramic

Tonelli design studio 2025



Ø120 x h 75	8 + 5	0,48	150	179	○	4.350
					○○	4.470
					○○○	4.490
Ø140 x h 75	8 + 5	0,54	150	197	○	4.740
					○○	4.860
					○○○	4.880
Ø160 x h 75	8 + 5	0,58	150	217	○	5.180
					○○	5.300
					○○○	5.320

- basamento **nero grafite o bianco opaco** / base **graphite black or matt white**
Gestell **Grafitschwarz oder matt weiß** / piètement **noir graphite ou mat blanc**
- basamento **Dark Brown** / base **Dark Brown**
Gestell **Dark Brown** / piètement **Dark Brown**
- basamento **Champagne, Titanio o Bronzo** / base **Champagne, Titanio or Bronzo**
Gestell **Champagnerfarbe, Titanio oder Bronzo** / piètement **Champagne, Titanio ou Bronzo**

Specificare sempre la finitura del basamento verniciato e della ceramica del top.

Always specify finish of laquered base and ceramic of top.

Immer Ausführung des lackierten Gestell angeben und Keramik des Tops.

Spécifier toujours finition du piètement laqué et céramique du top.

- Tavolo con basamento centrale in metallo. Finiture: nero grafite o bianco opaco, Dark Brown, Titanio, Champagne o Bronzo
Top rotondo o sagomato in ceramica nelle finiture: **Pietra di Savoia antracite bocciardato, Noir desir lucido o opaco, Calacatta oro venato lucido, Pietra Grey opaco, Sahara noir lucido o bocciardato e Travertino bocciardato.**
- Table with central base in metal. Finishes: graphite black or matt white, Dark Brown, Titanio, Champagne or Bronzo
Round or shaped top in ceramic, finishes: **Pietra di Savoia anthracite bocciardato, Noir desir polished or matt, Calacatta oro venato polished, Pietra Grey matt, Sahara noir polished or bocciardato, Travertino bocciardato.**
- Tisch mit zentralem Gestell aus Metall. Ausführungen: grafitschwarz oder matt weiß, Dark Brown, Titanio, Champagnerfarbe oder Bronzo.
Rundes oder profiliertes Top aus Keramik, Ausführungen: **Pietra di Savoia Anthrazit bocciardato, Noir desir glänzend oder matt, Calacatta oro venato glänzend, Pietra Grey matt, Sahara noir glänzend oder bocciardato, Travertino bocciardato.**
- Table avec base central en métal. Finitions: noir graphite ou blanc mat, Dark Brown, Titanio Champagne ou Bronzo.
Top rond ou profilé en céramique, finitions: **Pietra di Savoia anthracite mat, Noir desir brillant ou mat, Calacatta oro venato brillant, Pietra Grey mat, Sahar noir brillant ou bocciardato, Travertino bocciardato.**

	I E D F	dimensioni dimension abmessungen dimension	spessore thickness stärke épaisseur	volume volume volumen volume	carico ammesso admitted load tragfähigkeit charge admise	peso weight gewicht poids	prezzo price preis prix
		cm	mm	m3	kg	kg	euro

Wiston ceramic

Tonelli design studio 2025

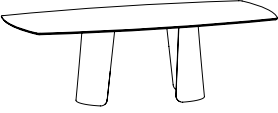
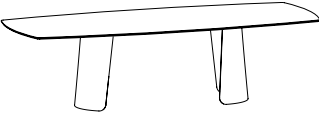
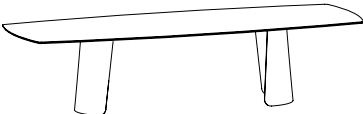
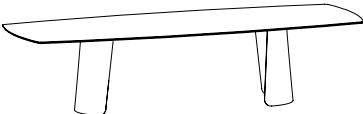
	200 x 110 x h 75	8 + 5	0,57	150	217	○ 5.800
						○○ 5.920
						○○○ 5.940
	240 x 115 x h 75	8 + 5	0,64	150	260	○ 6.540
						○○ 6.660
						○○○ 6.680
	280 x 115 x h 75	8 + 5	0,7	150	217	○ 6.950
						○○ 7.070
						○○○ 7.090
	320 x 115 x h 75	10 + 5	0,8	150	314	○ 7.620
						○○ 7.740
						○○○ 7.760

- basamento **nero grafite o bianco opaco** / base **graphite black or matt white**
Gestell **Grafitschwarz oder matt weiß** / piètement **noir graphite ou mat blanc**
- basamento **Dark Brown** / base **Dark Brown**
Gestell **Dark Brown** / piètement **Dark Brown**
- basamento **Champagne, Titanio o Bronzo** / base **Champagne, Titanio or Bronzo**
Gestell **Champagnerfarbe, Titanio oder Bronzo** / piètement **Champagne, Titanio ou Bronzo**

Specificare sempre la finitura del basamento verniciato e della ceramica del top.

Always specify finish of laquered base and ceramic of top.

Immer Ausföhrung des lackierten Gestell angeben und Keramik des Tops.

Spécifier toujours finition du piètement laqué et céramique du top.

- Tavolo con basamento centrale in metallo. Finiture: nero grafite o bianco opaco, Dark Brown, Titanio, Champagne o Bronzo.
Top rotondo o sagomato in ceramica nelle finiture: **Pietra di Savoia antracite bocciardato, Noir desir lucido o opaco, Calacatta oro venato lucido, Pietra Grey opaco, Sahara noir lucido o bocciardato e Travertino bocciardato.**

- Table with central base in metal. Finishes: graphite black or matt white, Dark Brown, Titanio, Champagne or Bronzo.
Round or shaped top in ceramic, finishes: **Pietra di Savoia anthracite bocciardato, Noir desir polished or matt, Calacatta oro venato polished, Pietra Grey matt, Sahara noir polished or bocciardato, Travertino bocciardato.**

- Tisch mit zentralem Gestell aus Metall. Ausföhrungen: grafitschwarz oder matt weiß, Dark Brown, Titanio, Champagnerfarbe oder Bronzo.
Rundes oder profiliertes Top aus Keramik, Ausföhrungen: **Pietra di Savoia Anthrazit bocciardato, Noir desir glänzend oder matt, Calacatta oro venato glänzend, Pietra Grey matt, Sahara noir glänzend oder bocciardato, Travertino bocciardato.**

- Table avec base central en métal. Finitions: noir graphite ou blanc mat, Dark Brown, Titanio Champagne ou Bronzo.
Top rond ou profilé en céramique, finitions: **Pietra di Savoia anthracite mat, Noir desir brillant ou mat, Calacatta oro venato brillant, Pietra Grey mat, Sahar noir brillant ou bocciardato, Travertino bocciardato.**

Wiston stone

Tonelli design studio 2025

dimensioni
dimension
dimensionen

spessore
thickness
stärke
épaisseur

volumi
volume
volumen
volumen

carico ammesso
admitted load
tragfähigkeit
charge admise

peso
weight
gewicht
poids

prezzo
price
preis
prix

cm	mm	m3	kg	kg	euro					
Ø 120 x h.75	20	0,6	150	223	Finiture top marmo / marble top finishes Marmortop Ausführungen / top marbre finitions					
					N.Marquinia Bianco Carrara	Sahara Noir	Travertino Romano	Arabescato Orobico Gold	Tropikal Storm	Domus White
					○ 7.280	7.960	8.980	9.450	9.860	10.280
					○○ 7.570	8.250	9.270	9.740	10.150	10.570
○○○ 7.590	8.270	9.290	9.760	10.170	10.590					
Ø 140 x h.75	20	0,66	150	248	Finiture top marmo / marble top finishes Marmortop Ausführungen / top marbre finitions					
					N.Marquinia Bianco Carrara	Sahara Noir	Travertino Romano	Arabescato Orobico Gold	Tropikal Storm	Domus White
					○ 8.310	9.200	10.550	10.920	11.520	12.050
					○○ 8.600	9.490	10.840	11.210	11.810	12.340
○○○ 8.620	9.510	10.860	11.230	11.830	12.360					
Ø 160 x h.75	20	0,7	150	276	Finiture top marmo / marble top finishes Marmortop Ausführungen / top marbre finitions					
					N.Marquinia Bianco Carrara	Sahara Noir	Travertino Romano	Arabescato Orobico Gold	Tropikal Storm	Domus White
					○ 9.490	10.690	11.830	12.610	12.860	13.510
					○○ 9.780	10.980	12.120	12.900	13.150	13.800
○○○ 9.800	11.000	12.140	12.920	13.170	13.820					
Ø 180 x h.75	20	0,82	150	308	Finiture top marmo / marble top finishes Marmortop Ausführungen / top marbre finitions					
					N.Marquinia Bianco Carrara	Sahara Noir	Travertino Romano	Arabescato Orobico Gold	Tropikal Storm	Domus White
					○ 10.770	11.550	13.610	14.390	15.180	15.990
					○○ 11.060	11.840	13.900	14.680	15.470	16.280
○○○ 11.080	11.860	13.920	14.700	15.490	16.300					

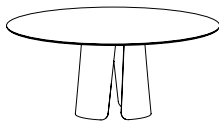

- basamento **nero grafite o bianco opaco** / base **graphite black or matt white**
Gestell **Grafitschwarz oder matt weiß** / piètement **noir graphite ou mat blanc**
- basamento **Dark Brown** / base **Dark Brown**
Gestell **Dark Brown** / piètement **Dark Brown**
- basamento **Champagne, Titanio o Bronzo** / base **Champagne, Titanio or Bronzo**
Gestell **Champagnerfarbe, Titanio oder Bronzo** / piètement **Champagne, Titanio ou Bronzo**

Specificare sempre la finitura del basamento verniciato e del marmo del top.

Always specify finish of laquered base and marble of top.

Immer Ausführung des lackierten Gestell angeben und Marmor des Tops.

Spécifier toujours finition du piètement laqué et marble du top.

- Tavolo con basamento centrale in metallo. Finiture: nero grafite o bianco opaco, Dark Brown, Titanio, Champagne o Bronzo.

Top rotondo o sagomato con bordo bisellato in marmo spazzolato opaco.

Finiture: **Nero Marquina, Bianco Carrara, Arabescato Orobico Gold, Sahara Noir, Tropikal Storm, Domus White e Travertino Romano.**

- Table with central base in metal. Finishes: graphite black or matt white, Dark Brown, Titanio, Champagne or Bronzo.

Round or shaped tops in matt brushed marble with bevelled edge.

Finishes: **Nero Marquina, Bianco Carrara, Arabescato Orobico Gold, Sahara Noir, Tropikal Storm, Domus White and Travertino Romano.**

- Tisch mit zentralem Gestell aus Metall. Ausführungen: Grafitschwarz oder matt weiß lackiert, Dark Brown, Titanio, Champagne oder Bronzo.
Aufsitztop rund oder profiliert aus matt gebürstetem Marmor mit Facettenschliff am Rand.

Ausführungen: **Nero Marquina, Bianco Carrara, Arabescato Orobico Gold, Sahara Noir, Tropikal Storm, Domus White und Travertino Romano.**

- Table avec base central en métal. Finitions: noir graphite ou mat blanc, Dark Brown, Titanio, Champagne ou Bronzo.

Top en appuis ronde ou profilé en marble brossé matte avec bord biseauté.

Finitions: **Nero Marquina, Bianco Carrara, Arabescato Orobico Gold, Sahara Noir, Tropikal Storm, Domus White et Travertino Romano.**

Wiston stone

Tonelli design studio 2025

dimensioni
dimensionen
dimensionen

spessore
thickness
stärke
épaisseur

volumi
volume
volumen
volumen

carico ammesso
admitted load
tragfähigkeit
charge admise

peso
weight
gewicht
poids

prezzo
price
preis
prix

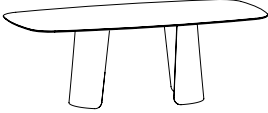
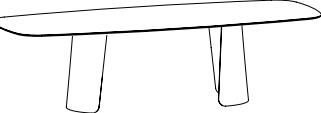
	cm	mm	m3	kg	kg	euro																											
	200 x 115 x h.75	20	0,64	150	299	Finiture top marmo / marble top finishes Marmortop Ausführungen / top marbre finitions																											
						<table border="1"> <tr> <th>N.Marquinia Bianco Carrara</th> <th>Sahara Noir</th> <th>Travertino Romano</th> <th>Arabescato Orobico Gold</th> <th>Tropikal Storm</th> <th>Domus White</th> </tr> <tr> <td>○</td> <td>8.680</td> <td>9.680</td> <td>10.260</td> <td>11.730</td> <td>12.450</td> <td>13.060</td> </tr> <tr> <td>○○</td> <td>8.970</td> <td>9.970</td> <td>10.550</td> <td>12.020</td> <td>12.740</td> <td>13.350</td> </tr> <tr> <td>○○○</td> <td>8.990</td> <td>9.990</td> <td>10.570</td> <td>12.040</td> <td>12.760</td> <td>13.370</td> </tr> </table>	N.Marquinia Bianco Carrara	Sahara Noir	Travertino Romano	Arabescato Orobico Gold	Tropikal Storm	Domus White	○	8.680	9.680	10.260	11.730	12.450	13.060	○○	8.970	9.970	10.550	12.020	12.740	13.350	○○○	8.990	9.990	10.570	12.040	12.760	13.370
						N.Marquinia Bianco Carrara	Sahara Noir	Travertino Romano	Arabescato Orobico Gold	Tropikal Storm	Domus White																						
						○	8.680	9.680	10.260	11.730	12.450	13.060																					
						○○	8.970	9.970	10.550	12.020	12.740	13.350																					
						○○○	8.990	9.990	10.570	12.040	12.760	13.370																					
	Finiture top marmo / marble top finishes Marmortop Ausführungen / top marbre finitions																																
	<table border="1"> <tr> <th>N.Marquinia Bianco Carrara</th> <th>Sahara Noir</th> <th>Travertino Romano</th> <th>Arabescato Orobico Gold</th> <th>Tropikal Storm</th> <th>Domus White</th> </tr> <tr> <td>○</td> <td>9.160</td> <td>10.260</td> <td>11.920</td> <td>13.530</td> <td>14.330</td> <td>15.000</td> </tr> <tr> <td>○○</td> <td>9.450</td> <td>10.550</td> <td>12.210</td> <td>13.820</td> <td>14.620</td> <td>15.290</td> </tr> <tr> <td>○○○</td> <td>9.470</td> <td>10.570</td> <td>12.230</td> <td>13.840</td> <td>14.640</td> <td>15.310</td> </tr> </table>	N.Marquinia Bianco Carrara	Sahara Noir	Travertino Romano	Arabescato Orobico Gold	Tropikal Storm	Domus White	○	9.160	10.260	11.920	13.530	14.330	15.000	○○	9.450	10.550	12.210	13.820	14.620	15.290	○○○	9.470	10.570	12.230	13.840	14.640	15.310					
	N.Marquinia Bianco Carrara	Sahara Noir	Travertino Romano	Arabescato Orobico Gold	Tropikal Storm	Domus White																											
	○	9.160	10.260	11.920	13.530	14.330	15.000																										
	○○	9.450	10.550	12.210	13.820	14.620	15.290																										
	○○○	9.470	10.570	12.230	13.840	14.640	15.310																										
Finiture top marmo / marble top finishes Marmortop Ausführungen / top marbre finitions																																	
<table border="1"> <tr> <th>N.Marquinia Bianco Carrara</th> <th>Sahara Noir</th> <th>Travertino Romano</th> <th>Arabescato Orobico Gold</th> <th>Tropikal Storm</th> <th>Domus White</th> </tr> <tr> <td>○</td> <td>9.880</td> <td>11.150</td> <td>13.210</td> <td>14.190</td> <td>15.170</td> <td>15.930</td> </tr> <tr> <td>○○</td> <td>10.170</td> <td>11.440</td> <td>13.500</td> <td>14.480</td> <td>15.460</td> <td>16.220</td> </tr> <tr> <td>○○○</td> <td>10.190</td> <td>11.460</td> <td>13.520</td> <td>14.500</td> <td>15.480</td> <td>16.240</td> </tr> </table>	N.Marquinia Bianco Carrara	Sahara Noir	Travertino Romano	Arabescato Orobico Gold	Tropikal Storm	Domus White	○	9.880	11.150	13.210	14.190	15.170	15.930	○○	10.170	11.440	13.500	14.480	15.460	16.220	○○○	10.190	11.460	13.520	14.500	15.480	16.240						
N.Marquinia Bianco Carrara	Sahara Noir	Travertino Romano	Arabescato Orobico Gold	Tropikal Storm	Domus White																												
○	9.880	11.150	13.210	14.190	15.170	15.930																											
○○	10.170	11.440	13.500	14.480	15.460	16.220																											
○○○	10.190	11.460	13.520	14.500	15.480	16.240																											
	240 x 120 x h.75	20	0,76	150	354	Finiture top marmo / marble top finishes Marmortop Ausführungen / top marbre finitions																											
						<table border="1"> <tr> <th>N.Marquinia Bianco Carrara</th> <th>Sahara Noir</th> <th>Travertino Romano</th> <th>Arabescato Orobico Gold</th> <th>Tropikal Storm</th> <th>Domus White</th> </tr> <tr> <td>○</td> <td>10.520</td> <td>11.890</td> <td>14.090</td> <td>15.150</td> <td>16.190</td> <td>16.990</td> </tr> <tr> <td>○○</td> <td>10.810</td> <td>12.180</td> <td>14.380</td> <td>15.440</td> <td>16.480</td> <td>17.280</td> </tr> <tr> <td>○○○</td> <td>10.830</td> <td>12.200</td> <td>14.400</td> <td>15.460</td> <td>16.500</td> <td>17.300</td> </tr> </table>	N.Marquinia Bianco Carrara	Sahara Noir	Travertino Romano	Arabescato Orobico Gold	Tropikal Storm	Domus White	○	10.520	11.890	14.090	15.150	16.190	16.990	○○	10.810	12.180	14.380	15.440	16.480	17.280	○○○	10.830	12.200	14.400	15.460	16.500	17.300
						N.Marquinia Bianco Carrara	Sahara Noir	Travertino Romano	Arabescato Orobico Gold	Tropikal Storm	Domus White																						
						○	10.520	11.890	14.090	15.150	16.190	16.990																					
						○○	10.810	12.180	14.380	15.440	16.480	17.280																					
						○○○	10.830	12.200	14.400	15.460	16.500	17.300																					
	Finiture top marmo / marble top finishes Marmortop Ausführungen / top marbre finitions																																
	<table border="1"> <tr> <th>N.Marquinia Bianco Carrara</th> <th>Sahara Noir</th> <th>Travertino Romano</th> <th>Arabescato Orobico Gold</th> <th>Tropikal Storm</th> <th>Domus White</th> </tr> <tr> <td>○</td> <td>11.170</td> <td>12.630</td> <td>15.030</td> <td>16.390</td> <td>17.540</td> <td>18.420</td> </tr> <tr> <td>○○</td> <td>11.460</td> <td>12.920</td> <td>15.320</td> <td>16.680</td> <td>17.830</td> <td>18.710</td> </tr> <tr> <td>○○○</td> <td>11.480</td> <td>12.940</td> <td>15.340</td> <td>16.700</td> <td>17.850</td> <td>18.730</td> </tr> </table>	N.Marquinia Bianco Carrara	Sahara Noir	Travertino Romano	Arabescato Orobico Gold	Tropikal Storm	Domus White	○	11.170	12.630	15.030	16.390	17.540	18.420	○○	11.460	12.920	15.320	16.680	17.830	18.710	○○○	11.480	12.940	15.340	16.700	17.850	18.730					
	N.Marquinia Bianco Carrara	Sahara Noir	Travertino Romano	Arabescato Orobico Gold	Tropikal Storm	Domus White																											
	○	11.170	12.630	15.030	16.390	17.540	18.420																										
	○○	11.460	12.920	15.320	16.680	17.830	18.710																										
	○○○	11.480	12.940	15.340	16.700	17.850	18.730																										
Finiture top marmo / marble top finishes Marmortop Ausführungen / top marbre finitions																																	
<table border="1"> <tr> <th>N.Marquinia Bianco Carrara</th> <th>Sahara Noir</th> <th>Travertino Romano</th> <th>Arabescato Orobico Gold</th> <th>Tropikal Storm</th> <th>Domus White</th> </tr> <tr> <td>○</td> <td>11.170</td> <td>12.630</td> <td>15.030</td> <td>16.390</td> <td>17.540</td> <td>18.420</td> </tr> <tr> <td>○○</td> <td>11.460</td> <td>12.920</td> <td>15.320</td> <td>16.680</td> <td>17.830</td> <td>18.710</td> </tr> <tr> <td>○○○</td> <td>11.480</td> <td>12.940</td> <td>15.340</td> <td>16.700</td> <td>17.850</td> <td>18.730</td> </tr> </table>	N.Marquinia Bianco Carrara	Sahara Noir	Travertino Romano	Arabescato Orobico Gold	Tropikal Storm	Domus White	○	11.170	12.630	15.030	16.390	17.540	18.420	○○	11.460	12.920	15.320	16.680	17.830	18.710	○○○	11.480	12.940	15.340	16.700	17.850	18.730						
N.Marquinia Bianco Carrara	Sahara Noir	Travertino Romano	Arabescato Orobico Gold	Tropikal Storm	Domus White																												
○	11.170	12.630	15.030	16.390	17.540	18.420																											
○○	11.460	12.920	15.320	16.680	17.830	18.710																											
○○○	11.480	12.940	15.340	16.700	17.850	18.730																											

- basamento **nero grafite o bianco opaco** / base **graphite black or matt white**
Gestell **Grafit schwarz oder matt weiß** / piètement **noir graphite ou mat blanc**
- basamento **Dark Brown** / base **Dark Brown**
Gestell **Dark Brown** / piètement **Dark Brown**
- basamento **Champagne, Titanio o Bronzo** / base **Champagne, Titanio or Bronzo**
Gestell **Champagnerfarbe, Titanio oder Bronzo** / piètement **Champagne, Titanio ou Bronzo**

Specificare sempre la finitura del basamento verniciato e del marmo del top.

Always specify finish of laquered base and marble of top.

Immer Ausführung des lackierten Gestell angeben und Marmor des Tops.

Spécifier toujours finition du piètement laqué et marble du top.

- Tavolo con basamento centrale in metallo. Finiture: nero grafite o bianco opaco, Dark Brown, Titanio, Champagne o Bronzo.
Top rotondo o sagomato con bordo bisellato in marmo spazzolato opaco.
Finiture: **Nero Marquina, Bianco Carrara, Arabescato Orobico Gold, Sahara Noir, Tropikal Storm, Domus White e Travertino Romano.**
- Table with central base in metal. Finishes: graphite black or matt white, Dark Brown, Titanio, Champagne or Bronzo.
Round or shaped tops in matt brushed marble with bevelled edge.
Finishes: **Nero Marquina, Bianco Carrara, Arabescato Orobico Gold, Sahara Noir, Tropikal Storm, Domus White and Travertino Romano.**
- Tisch mit zentralem Gestell aus Metall. Ausführungen: Grafit schwarz oder matt weiß lackiert, Dark Brown, Titanio, Champagne oder Bronzo.
Aufsitztop rund oder profiliert aus matt gebürstetem Marmor mit Facettenschliff am Rand.
Ausführungen: **Nero Marquina, Bianco Carrara, Arabescato Orobico Gold, Sahara Noir, Tropikal Storm, Domus White und Travertino Romano.**
- Table avec base central en métal. Finitions: noir graphite ou mat blanc, Dark Brown, Titanio, Champagne ou Bronzo.
Top en appuis ronde ou profilé en marble brossé matte avec bord biseauté.
Finitions: **Nero Marquina, Bianco Carrara, Arabescato Orobico Gold, Sahara Noir, Tropikal Storm, Domus White et Travertino Romano.**

tavoli XXL | tables XXL

	I E D F	dimensioni dimension abmessungen dimension	spessore thickness stärke épaisseur	volume volume volumen volume	carico ammesso admitted load tragfähigkeit charge admise	peso weight gewicht poids	prezzo price preis prix
		cm	mm	m3	kg	kg	euro

Metropolis XXL design G. Maurizio Scutellà 2022	Ø 240 x h 75	12	3,60	150	347	<input type="checkbox"/> 8.780
						<input checked="" type="checkbox"/> 9.920
						<input checked="" type="checkbox"/> 10.420

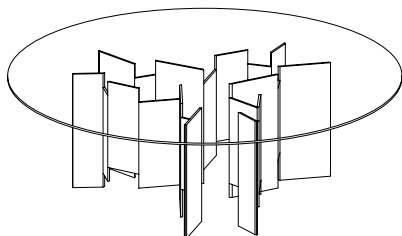

Metropolis XXL design G. Maurizio Scutellà 2022	400 x 120 x h 75	12	2,52	150	300	<input type="checkbox"/> 8.710
						<input checked="" type="checkbox"/> 9.840
						<input checked="" type="checkbox"/> 10.340

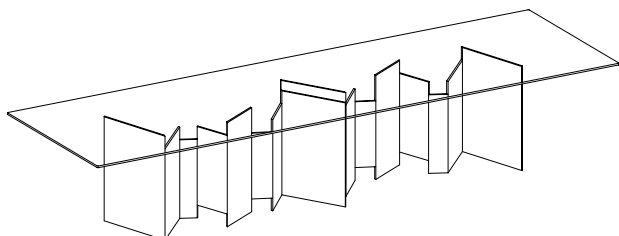

- top e basamento vetro extrachiaro / extra clear glass top and base
Top und Gestell aus extrahellem Glas / top et piètement en verre extra clair
- top e basamento vetro fumè / smoked glass top and base
Top und Gestell aus Rauchglas / top et piètement en verre fumé
- top e basamento vetro bronzo / bronze glass top and base
Top und Gestell aus Bronze Glas / top et piètement en verre bronze

- Tavolo con basamento centrale in vetro extrachiaro, fumè o bronzo. Top in vetro extrachiaro, fumè o bronzo.
- Dining table with central base in extra clear or smoked glass. Table top extra clear glass or smoked glass.
- Esstisch mit zentralem Gestell aus extrahellem Glas oder Rauchglas. Topplatte aus extrahellem Glas oder Rauchglas.
- Table avec piètement central en verre extra clair ou fumé. Top en verre extra clair ou fumé.

	I E D F	dimensioni dimension abmessungen dimension	spessore thickness stärke épaisseur	volume volume volumen volume	carico ammesso admitted load tragfähigkeit charge admise	peso weight gewicht poids	prezzo price preis prix
		cm	mm	m3	kg	kg	euro

Metropolis XXL design G. Maurizio Scutellà 2022	320 x 160 x h 75	12	3,09	150	366	<input type="checkbox"/> 9.120
						<input checked="" type="checkbox"/> 10.300
						<input checked="" type="checkbox"/> 10.820

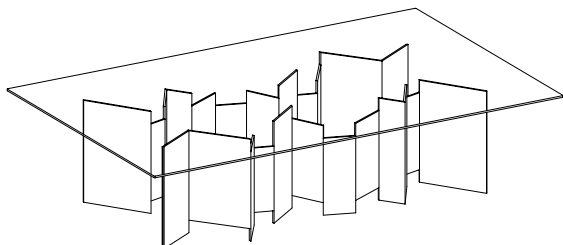

Metropolis XXL design G. Maurizio Scutellà 2022	320 x 200 x h 75	12	3,22	150	406	<input type="checkbox"/> 9.950
						<input checked="" type="checkbox"/> 11.240
						<input checked="" type="checkbox"/> 11.810

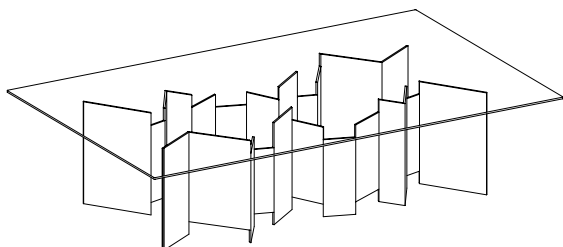

- top e basamento vetro extrachiaro / extra clear glass top and base
Top und Gestell aus extrahellem Glas / top et piètement en verre extra clair
- top e basamento vetro fumè / smoked glass top and base
Top und Gestell aus Rauchglas / top et piètement en verre fumé
- top e basamento vetro bronzo / bronze glass top and base
Top und Gestell aus Bronze Glas / top et piètement en verre bronze

- Tavolo con basamento centrale in vetro extrachiaro, fumè o bronzo. Top in vetro extrachiaro, fumè o bronzo.
- Dining table with central base in extra clear or smoked glass. Table top extra clear glass or smoked glass.
- Esstisch mit zentralem Gestell aus extrahellem Glas oder Rauchglas. Topplatte aus extrahellem Glas oder Rauchglas.
- Table avec piètement central en verre extra clair ou fumé. Top en verre extra clair ou fumé.

tavoli allungabili | extending tables

	I E D F	dimensioni dimension abmessungen dimension	spessore thickness stärke épaisseur	volume volume volumen volume	carico ammesso admitted load tragfähigkeit charge admise	peso weight gewicht poids	prezzo price preis prix
		cm	mm	m3	kg	kg	euro

Livingstone

design Giulio Mancini 2006/2010

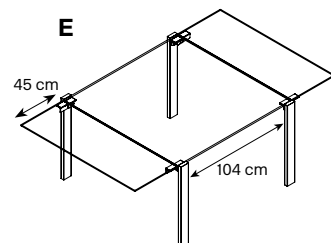
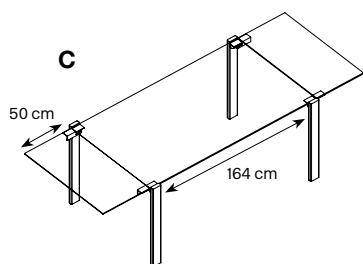
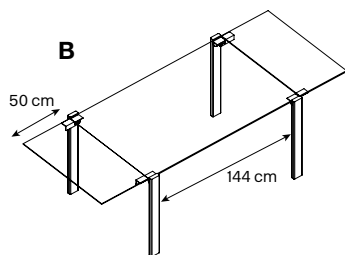
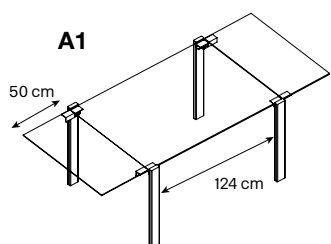
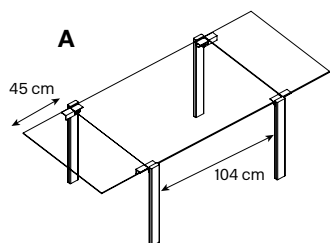

A	120/210 x 90 x h 74	15 / 10	0,45	170 * / 40 * *	100	□ 3.830
A1	140/240 x 90 x h 74	15 / 10	0,47	170 * / 40 * *	106	□ 3.900
B	160/260 x 90 x h 74	15 / 10	0,48	170 * / 40 * *	108	□ 3.970
C	180/280 x 90 x h 74	15 / 10	0,53	170 * / 40 * *	115	□ 4.110
E	120/210 x 120 x h 74	15 / 10	0,54	170 * / 40 * *	118	□ 4.160

Maggiorazione per gambe in finitura: **BRONZO, CANNA DI FUCILE o CHAMPAGNE.**

240

Surcharge for legs finishing in: **BRONZE, GUNMETAL OR CHAMPAGNE.**

Aufpreis für Beine in Ausführung: **BRONZE, GUNMETAL ODER CHAMPAGNE..**

Surcoût pour pieds en finition: **BRONZE, GUNMETAL OU CHAMPAGNE.**

- Piano extrachiaro con allunghi extrachiaro / extra clear glass top and extra clear extension leaves /
 Glasplatte extrahell mit extrahellen Verlängerungsplatten / plateau en verre extra clair avec rallonges extra claires

SPECIFICARE SEMPRE FINITURA GAMBE / ALWAYS SPECIFY LEGS FINISHING.

IMMER DIE AUSFÜHRUNG DER BEINE ANGEBEN / SPECIFIEZ TOUJOURS LA FINITION DES PIEDS.

* per tavolo/for table/für den Tisch/pour table ** per allungo/for extension/für Verlängerungsstück/pour allonge

- Tavolo allungabile in vetro temprato. Piano in vetro: extrachiaro.

Gambe in metallo cromato, CROMATO OPACO, verniciate opaco bianche o nere.

- Extending table in tempered glass. Glass top: extraclear.

Legs in chrome, MATT CHROME, black or white mat lacquered.

- Hoher verlängerbarer Tisch aus Sicherheitsglas. Tischplatte: extrahell.

Beine verchromt, CHROM MATT, schwarz oder weiß matt lackiert.

- Table haute avec rallonges en verre trempé. Plateau: extra claire.

Pieds chromés, CHROME OPAQUE, laqués noir ou blanc opaque.

	I E D F	dimensioni dimension abmessungen dimension	spessore thickness stärke épaisseur	volume volume volumen volume	carico ammesso admitted load tragfähigkeit charge admise	peso weight gewicht poids	prezzo price preis prix
		cm	mm	m3	kg	kg	euro

Livingstone wood leg

design Giulio Mancini 2006/ 2014

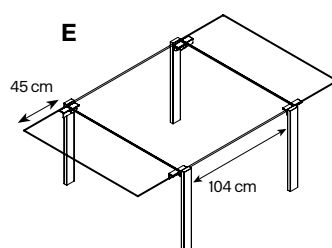
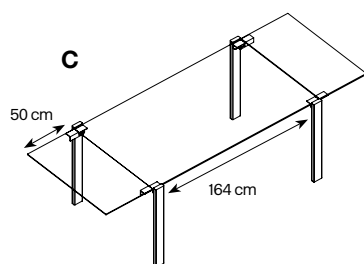
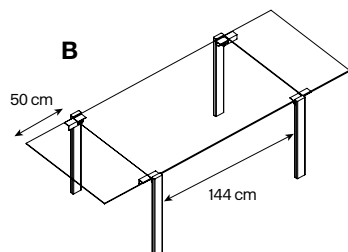
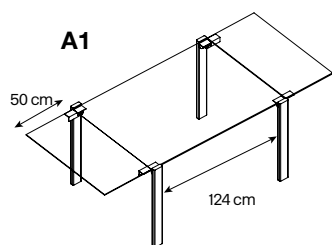
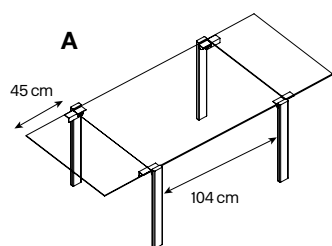

120/210 x 90 x h 74 A	15 / 10	0,45	170 * / 40 * *	100	□ 4.070
140/240 x 90 x h 74 A1	15 / 10	0,47	170 * / 40 * *	106	□ 4.140
160/260 x 90 x h 74 B	15 / 10	0,48	170 * / 40 * *	108	□ 4.210
180/280 x 90 x h 74 C	15 / 10	0,53	170 * / 40 * *	115	□ 4.350
120/210 x 120 x h 74 E	15 / 10	0,54	170 * / 40 * *	118	□ 4.400

□ Piano extrachiaro con allunghi extrachiaro / extra clear glass top and extra clear extension leaves /
 Glasplatte extrahell mit extrahellen Verlängerungsplatten / plateau en verre extra clair avec rallonges extra claires

SPECIFICARE SEMPRE FINITURA GAMBE / ALWAYS SPECIFY LEGS FINISHING.
IMMER DIE AUSFÜHRUNG DER BEINE ANGEBEN / SPECIFIEZ TOUJOURS LA FINITION DES PIEDS.

* per tavolo/for table/für den Tisch/pour table ** per allungo/for extension/für Verlängerungsstück/pour allonge

- Tavolo allungabile in vetro temperato. Piano in vetro: trasparente o extrachiaro.
Gambe in legno noce canaletto, rovere naturale, Siberian Ash oppure Eucalipto.
- Extending table in tempered glass. Glass top: transparent or extra clear.
Legs in canaletto walnut, natural oak, Siberian ash or Eucalipto.
- Hoher verlängerbarer Tisch aus Sicherheitsglas. Tischplatte: transparent, extrahell.
Beine aus Walnuß Canaletto, Eiche Natur, Siberian Ash or Eucalipto.
- Table haute avec rallonges en verre trempé. Plateau: transparent, extra clair.
Pieds en noyer canaletto, rovere naturel, Siberian Ash ou Eucalipto.

	I E D F	dimensioni dimension abmessungen dimension	spessore thickness stärke épaisseur	volume volume volumen volume	carico ammesso admitted load tragfähigkeit charge admise	peso weight gewicht poids	prezzo price preis prix
		cm	mm	m3	kg	kg	euro

Livingstone Dark

design Giulio Mancini 2020

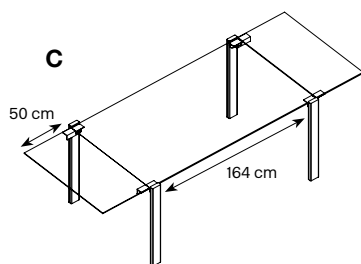
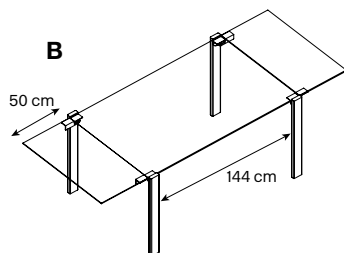
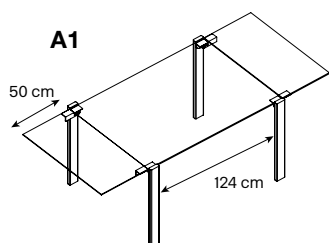
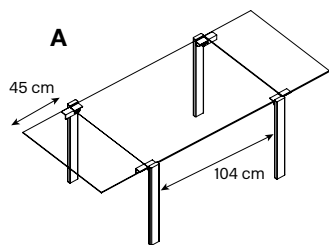

120/210 x 90 x h 74 A	10+6 / 10	0,45	170 * / 40 * *	110	■ 3.870 ■ 3.880
140/240 x 90 x h 74 A1	10+6 / 10	0,47	170 * / 40 * *	116	■ 3.940 ■ 3.950
160/260 x 90 x h 74 B	10+6 / 10	0,48	170 * / 40 * *	119	■ 4.050 ■ 4.060
180/280 x 90 x h 74 C	10+6 / 10	0,5	170 * / 40 * *	129	■ 4.240 ■ 4.250

Maggiorazione per gambe in finitura: **BRONZO, CANNA DI FUCILE o CHAMPAGNE.** 240
 Surcharge for legs finishing in: **BRONZE, GUNMETAL OR CHAMPAGNE.**
 Aufpreis für Beine in Ausführung: **BRONZE, GUNMETAL ODER CHAMPAGNE.**
 Surcoût pour pieds en finition: **BRONZE, GUNMETAL OU CHAMPAGNE.**

Maggiorazione per gambe in LEGNO finitura: 240
NOCE CANALETTO, ROVERE NATURALE, SIBERIAN ASH oppure **EUCALIPTO**
 Surcharge for legs in WOOD finishing:
WALNUT CANALETTO, NATURAL OAK, SIBERIAN ASH or **EUCALIPTO**
 Aufpreis für Beine aus HOLZ, Ausführung:
WALNUSS CANALETTO, EICHE NATUR, SIBERIAN ASH oder **EUCALIPTO**
 Augmentation pour pieds en BOIS, finition:
NOYER CANALETTO, ROUVRE NATUREL, SIBERIAN ASH ou **EUCALIPTO**

- Vetro Fumè / smoked glass / Rauchglas / verre fumé
- Vetro Bronzo / bronze glass / Glas Bronze / verre bronze

Specificare sempre finitura del vetro / Always specify glass finish
Immer Glasausführung angeben / Spécifiez toujours la finition du verre

Specificare sempre finitura gambe / Always specify legs finishing.
Immer die Ausführung der Beine angeben / Spécifiez toujours la finition des pieds.

* per tavolo / for table / für den Tisch / pour table ** per allungo / for extension / für Verlängerungsstück / pour allonge

- Tavolo alto allungabile in vetro stratificato e temperato. Piano in vetro fumè o bronzo, gambe in metallo cromato, cromato opaco, verniciato opaco bianco o nero.
- Extending table in stratified and tempered glass. Top in smoked or bronze glass, metal legs in chrome, matt chrome, matt black or white lacquered.
- Verlängerbarer Tisch in gehärtetem Schichtglas. Tischplatte aus Rauchglas oder Bronze Glas, Metallbeine in Chrom, Chrom matt, matt schwarz oder weiß lackiert.
- Table avec rallonges en verre stratifié et trempé. Plateau en verre fumé ou bronze, pieds en métal chromé, chromé mat, laqués noir ou blanc mat.

	I E D F	dimensioni dimension abmessungen dimension	spessore thickness stärke épaisseur	volume volume volumen volume	carico ammesso admitted load tragfähigkeit charge admise	peso weight gewicht poids	prezzo price preis prix
		cm	mm	m3	kg	kg	euro
T5 E ceramic design Giulio Mancini 2019		160/250 x 100 x h 75	6 + 5	0,93	150 * / 40 **	172	○ 5.330 ○○ 5.760
		180/270 x 100 x h 75	6 + 5	1,01	150 * / 40 **	194	○ 5.550 ○○ 5.980

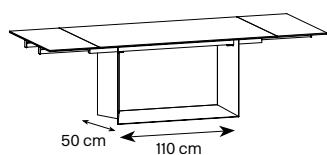

- nero grafite / graphite black / Grafitschwarz / noir graphite
○○ Bronzo / Bronzo / Bronzo / Bronzo

- * per piano centrale / central top / zentrale Platte / plateau central
** ogni allungo / each extension / jede Verlängerung / chaque allonge

**Specificare sempre la finitura del top ceramica / always specify ceramic top finish
immer Ausführung der Keramikplatte angeben / toujours spécifier finition top céramique**

- Tavolo allungabile con basamento centrale nelle finiture: Bronzo e verniciato nero grafite. Top e due allunghe in ceramica a vena continua nelle finiture: **Pietra di Savoia antracite bocciardato, Noir desir lucido o opaco, Calacatta oro venato lucido, Pietra Grey opaco, Sahara noir lucido o bocciardato o Travertino.** Il meccanismo allungabile è sempre verniciato nero opaco.
- Extending table with central base in: Bronzo or graphite black lacquered. Top and extensions in ceramic with uninterrupted grain in following finishes: **Pietra di Savoia anthracite bocciardato, Noir desir polished or matt, Calacatta oro venato polished, Pietra Grey matt, Sahara noir polished or bocciardato or Travertino.** Extension mechanism always matt black lacquered.
- Ausziehbarer Tisch mit zentralem Gestell in: Bronzo oder Grafitschwarz lackiert. Top und Verlängerungen aus Keramik mit ununterbrochener Maserung: **Pietra di Savoia Anthrazit bocciardato, Noir desir glänzend oder matt, Calacatta oro venato glänzend, Pietra Grey glänzend oder matt, Sahara noir glänzend oder bocciardato oder Travertino.** Ausziehmechanismus immer matt schwarz lackiert.
- Table extensible avec piètement central en: Bronzo ou noir graphite mat. Top et allonges en céramique avec veine continue dans les finitions: **Pietra di Savoia anthracite mat, Noir desir brillant ou mat, Calacatta oro venato brillant, Pietra Grey mat, Sahar noir brillant ou bocciardato ou Travertino.** Mécanisme d'allonge toujours laqué noir mat.

tavoli da bistrot | bistrot tables

	I	dimensioni	spessore	volume	carico ammesso	peso	prezzo
	E	dimension	thickness	volume	admitted load	weight	price
	D	abmessungen	stärke	volumen	tragfähigkeit	gewicht	preis
	F	dimension	épaisseur	volume	charge admise	poids	prix
		cm	mm	m3	kg	kg	euro

Farniente bistrot

design G.T. Garattoni 2026

Ø 60 x h 102

10
10
10
8+5

0,118

90

43

□ 1.830
■ 1.840
■ 1.850
● 1.980

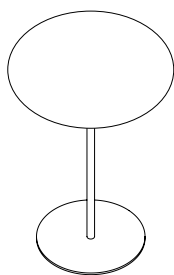
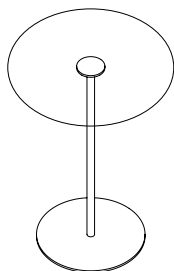

Maggiorazione basamento in finitura: **canna di fucile o Champagne**
Upcharge for base in finish: **gunmetal or Champagne**
Aufpreis für Gestell aus: **Gunmetal oder Champagne**
Surcharge pour base en: **canon de fusil ou Champagne**

350

- Vetro extrachiaro / extra clear glass / extrahelles Glas / verre extra clair
- Vetro fumé / smoked glass / Rauchglas / verre fumé
- Vetro bronzo / bronze glass / Bronze Glas / Verre bronze
- Ceramica / Ceramic / Keramik / céramique

Disponibile con dimensioni a richiesta.

Special sizes available.

Sondermaße sind möglich.

Dimensions spéciales sur demande.

- Tavolo bistrot con top in vetro extrachiaro, fumé o bronzo o in ceramica + vetro nelle seguenti finiture: **Pietra di Savoia antracite bocciardato, Noir desir lucido o opaco, Calacatta oro venato lucido, Pietra Grey opaco, Sahara noir lucido o bocciardato e Travertino.** Basamento in finitura cromata, canna di fucile o Champagne.
- Bistrot table with top in extra clear, smoked or bronze glass or made of ceramic+glass with following finishes: **Pietra di Savoia anthracite bushhammered, Noir desir polished or matt, Calacatta oro venato polished, Pietra Grey matt, Sahara noir polished or bushhammered or Travertino.** Base in chrome, gunmetal or Champagne finish.
- Bistrot Tisch mit Platte aus extrahellem Glas, Rauchglas oder Bronze Glas oder aus Keramik+Glas in folgenden Ausfertigungen: **Pietra di Savoia Anthrazit bocciardato, Noir desir glänzend oder matt, Calacatta oro venato glänzend, Pietra Grey matt, Sahara noir glänzend oder bocciardato oder Travertino.** Gestell in Chrom, gunmetal oder Champagne.
- Bistrot Table avec plateau en verre extra clair, fumé ou bronze ou en céramique+verre dans les suivants finitions: **Pietra di Savoia anthracite bouchardé, Noir desir brillant ou mat, Calacatta oro venato brillant, Pietra Grey mat, Sahar noir brillant ou bouchardé ou Travertino.** Piètement en chrome, canon de fusil ou Champagne.

home office | home office

	I E D F	dimensioni dimension abmessungen dimension	spessore thickness stärke épaisseur	volume volume volumen volume	carico ammesso admitted load tragfähigkeit charge admise	peso weight gewicht poids	prezzo price preis prix
		cm	mm	m3	kg	kg	euro
Logica design Fauciglietti Engineering		120 x 60 x h 73	15	0,235	100	85	2.600
		140 x 60 x h 73	15	0,256	100	92	2.670
		160 x 80 x h 73	15	0,42	100	127	2.990
		180 x 90 x h 73	15	0,432	100	150	3.180
		200 x 90 x h 73	15	0,462	100	160	3.290
		200 x 100 x h 73	15	0,51	100	176	3.430
		220 x 90 x h 73	15	0,492	100	174	3.360

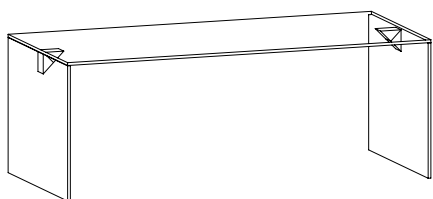

- Scrivania completamente smontabile, in vetro extrachiario temperato da 15 mm, con supporti di fissaggio in acciaio inossidabile spazzolato. Disponibile anche fuori misura su richiesta.
- Completely demountable desk in 15 mm extra clear tempered glass, with fixings in brushed stainless steel. Also available in custom size.
- Komplet zerblegbarer Schreibtisch in extrahellem 15 mm dickem Sicherheitsglas, mit Befestigungen in gebürstetem Edelstahl. Auch in Sondermaß erhältlich.
- Bureau complètement démontable en verre trempé extra clair de 15 mm, avec supports de fixation en acier inox brossé. Aussi disponible sur mesure.

Penrose desk design Isao Hosoe 2013 con Lucia Fontana e Masaya Hashimoto		185 x 78 x h 75	15	1,37	80	77	□ 2.870
---	--	-----------------	----	------	----	----	---------

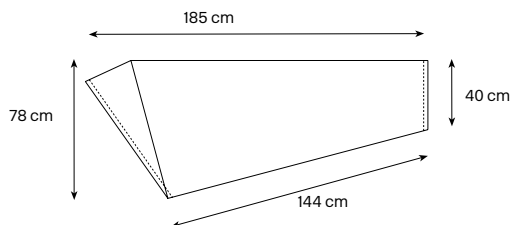
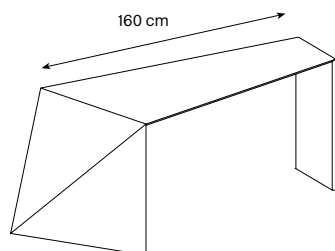

- Vetro extrachiario / extra clear glass / Glas extrahell / verre extra clair

- Scrivania di forma irregolare. Disponibile in vetro extrachiario.
- Irregular shaped desk. Available in clear glass.
- Schreibtisch in irregulärer Form. In extrahellem Glas erhältlich.
- Bureau en forme irrégulière. Disponible en verre extra clair.

	I	dimensioni	spessore	volume	carico ammesso	peso	prezzo
	E	dimension	thickness	volume	admitted load	weight	price
	D	abmessungen	stärke	volumen	tragfähigkeit	gewicht	preis
	F	dimension	épaisseur	volume	charge admise	poids	prix
		cm	mm	m3	kg	kg	euro

Marcell desk

design Massimo Castagna 2021

H 130 x 60 x h 75	12	0,92	60 + 10 *	81	<input type="checkbox"/> 2.200 <input checked="" type="checkbox"/> 2.260
G 150 x 60 x h 75	12	1,01	60 + 10 *	94	<input type="checkbox"/> 2.880 <input checked="" type="checkbox"/> 2.990
F 150 x 60 x h 75	12	1,01	60 + 10 *	94	<input type="checkbox"/> 3.700 <input checked="" type="checkbox"/> 3.830

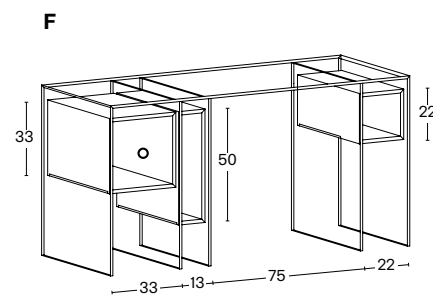
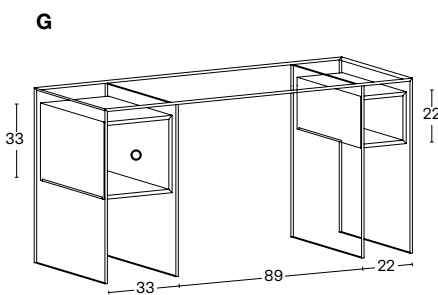
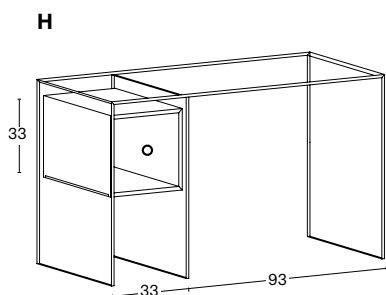

* per ogni contenitore / for each storage unit / für jeden Behälter / pour chaque récipient

- vetro extrachiaro / extra clear glass / extrahelles Glas / verre extra clair
 vetro fumè / smoked glass / Rauchglas / verre fumé

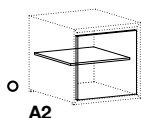

A2

- A2** Optional anta battente SX in finitura Eucalipto, Siberian Ash o Rovere Naturale e ripiano interno in vetro **240**
 Optional hinge door left in finish Eucalipto, Siberian Ash or natural oak and internal glass shelf
 Optional Drehflügel Tür links aus Eucalipto, Siberian Ash oder Eiche Natur und internes Glasfach
 Option porte à battant gauche en Eucalipto, Siberian Ash ou rouvre naturel et étagère en verre intérieur

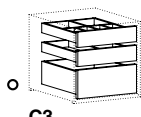

C3

- C3** Optional set 3 cassetti portaoggetti, completi di separatori in legno, in finitura Eucalipto, Siberian Ash o Rovere Naturale **580**
 Optional set of 3 glove box drawers, including wooden partition, in Eucalipto, Siberian Ash or natural oak
 Optional set von 3 Handschuhfächern, komplett mit innerer Abtrennung aus Holz, aus Eucalipto, Siberian Ash oder Eiche Natur
 Option set de 3 tiroirs boîte à gants, complet de cloisons en bois, en finition Eucalipto, Siberian Ash ou rouvre naturel

Specificare la finitura in legno dei contenitori e degli optional SIBERIAN ASH, EUCALIPTO o ROVERE NATURALE
Specify wood finish of storage unit and optional elements SIBERIAN ASH, EUCALIPTO or NATURAL OAK
Holzausführung der Behälter und optionalen Teile angeben SIBERIAN ASH, EUCALIPTO oder EICHE NATUR
Indiquer finition bois des récipients et des éléments optionnels SIBERIAN ASH, EUCALIPTO ou ROUVRE NATUREL

- Scrivitoio con struttura incollata in vetro e contenitori in legno in finitura Eucalipto, Siberian Ash o Rovere Naturale.

Optionalio con struttura incollata in vetro e contenitori in legno in finitura Eucalipto, Siberian Ash o Rovere Naturale. Lo scrivitoio può essere completato con lo specchio in appoggio Marcell Mirror

- Desk with glued structure made of glass and wooden storage units in Eucalipto, Siberian Ash or natural oak finish.

Optional hinge door left or set of 3 glove box drawers in matching finish.

The desk can also be completed with the countertop Marcell Mirror

- Schreibtisch mit verklebter Struktur aus Glas und Behälter aus Holz in Ausführung Eucalipto, Siberian Ash oder Eiche Natur.

Optional Drehflügeltür links oder set von 3 Handschuhfächern in kombinierter Ausführung.

Der Schreibtisch kann auch mit dem aufstellbarem Spiegel Marcell Mirror ergänzt werden

- Bureau avec structure collée en verre et récipients en bois en finition Eucalipto, Siberian Ash ou rouvre naturel.

Optionnelle porte à battant gauche ou set de 3 tiroirs boîte à gants en finition assorti.

Le bureau peut être aussi complété avec le miroir en appuy Marcell Mirror

sedie | chairs

	I E D F	dimensioni dimension abmessungen dimension	spessore thickness stärke épaisseur	volume volume volumen volume	carico ammesso admitted load tragfähigkeit charge admise	peso weight gewicht poids	prezzo price preis prix
		cm	mm	m3	kg	kg	euro

Aw_chair

49x58xh 81

0,36

6

design Massimo Castagna 2023/2025

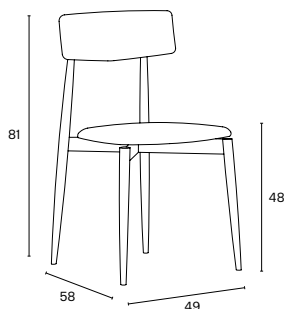

**ORDINE MINIMO N. 4 SEDIE / MINIMUM ORDER N. 4 CHAIRS
MINDESTBESTELLUNG N.4 STÜHLE / COMMANDE MINIMUM N. 4 CHAISES**

FINITURA STRUTTURA / STRUCTURE FINISH STRUKTURAUSFÜHRUNG / FINITION STRUCTURE	SEDUTA-SCHIENALE / SEAT-BACKREST / SITZ-SITZLEHNE / ASSISE-DOSSIER TESSUTO / FABRIC / STOFF / TISSU					
	C	P	H	F	B	D
laccato nero poro aperto / open grain black lacquered offenporig schwarz lackiert / laque noir pores ouverts	590	610	635	640	670	690
rovere naturale / natural oak natur eiche / rouvre naturel	615	635	660	665	695	715
siberian ash / eucalipto	610	630	655	660	690	710

Seduta sfoderabile/removable seat cover/abziehbarer Bezug der Sitzfläche/revêtement siège déhoussable **60**

Versione imbottitura ignifuga/fireproof upholstery version/ Version feuerhemmende Polsterung/version rembourrage ignifuge **80**

**Finiture tessuti vedi catalogo
Fabric finishes see catalogue
Stoffausführungen siehe Katalog
Finitions tissus voir catalogues**

**Per informazioni su eventuale tessuto cliente rivolgersi all'ufficio vendite per prezzo e metraggi.
For information on possible custom fabrics contact sales office for price and length.
Für Informationen bezüglich personalisierter Stoffe bitte wenden Sie sich an unser Verkaufsbüro für Preise und Maße.
Pour information sur tissus personnalisés contactez notre bureau de vente pour prix et métrage.**

- Sedia in legno massello di frassino. Seduta sagomata e imbottita, rivestita in tessuto.
Schienale in legno curvato a vista sul retro, imbottito e rivestito in tessuto frontalmente con cucitura a cordone sul bordo
Giunto di unione fra schienale e struttura in metallo opaco. Sedia non sfoderabile.
- Chair in solid ash wood. Shaped and upholstered seat, covered in fabric.
Curved wooden backrest, frontally upholstered and covered in fabric with cord stitching on the edge.
Junction between backrest and structure in matt metal. Covering not removable. Fabric covering not removable.
- Holzstuhl aus massivem Eschenholz. Profilerter und gepolsterter Sitz mit Stoff überzogen.
Rücklehne aus gebogenem Holz, vorne gepolstert und Stoffbekleidung mit Kordelnaht am Rand.
Verbindung zwischen Rücklehne und Struktur aus mat Metall. Nicht abziehbarer Stuhl.
- Chaise en bois massif de frêne. Assise profilé et rembourré, revêtu en tissu.
Dos en bois incurvé, rembourré et revêtu en tissu frontalement avec couture à cordon sur le bord.
Joint entre dos et structure en métal mat. Chaise non déhoussable.

	I E D F	dimensioni dimension abmessungen dimension	spessore thickness stärke épaisseur	volume volume volumen volume	carico ammesso admitted load tragfähigkeit charge admise	peso weight gewicht poids	prezzo price preis prix
		cm	mm	m3	kg	kg	euro

Dea

49x47xh80

0,33

6

design Giovanna Azzarello 2026

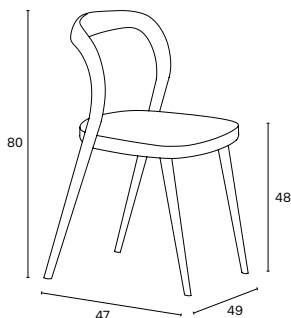

**ORDINE MINIMO N. 4 SEDIE / MINIMUM ORDER N. 4 CHAIRS
MINDESTBESTELLUNG N.4 STÜHLE / COMMANDE MINIMUM N. 4 CHAISES**

FINITURA STRUTTURA / STRUCTURE FINISH STRUKTURAUSFÜHRUNG / FINITION STRUCTURE	SEDUTA / SEAT-BACKREST / SITZ / ASSISE TESSUTO / FABRIC / STOFF / TISSU					
	C	P	H	F	B	D
laccato nero poro aperto / open grain black lacquered offenporig schwarz lackiert / laque noir pores ouverts	890	910	935	940	970	1.000
rovere naturale / natural oak natur eiche / rouvre naturel	915	935	960	965	995	1.025
siberian ash / eucalipto	910	930	955	960	990	1.020

Seduta sfoderabile/removable seat cover/abziehbarer Bezug der Sitzfläche/revêtement siège déhoussable **60**

Versione imbottitura ignifuga/fireproof upholstery version/ Version feuerhemmende Polsterung/version rembourrage ignifuge **80**

**Finiture tessuti vedi catalogo
Fabric finishes see catalogue
Stoffausführungen siehe Katalog
Finitions tissus voir catalogues**

**Per informazioni su eventuale tessuto cliente rivolgersi all'ufficio vendite per prezzo e metraggi.
For information on possible custom fabrics contact sales office for price and length.
Für Informationen bezüglich personalisierter Stoffe bitte wenden Sie sich an unser Verkaufsbüro für Preise und Maße.
Pour information sur tissus personnalisés contactez notre bureau de vente pour prix et métrage.**

- Sedia in legno massello curvato con gambe tornite e struttura a traversi incrociati.
Seduta sagomata e imbottita, rivestita in tessuto. Sfoderabile su richiesta.
- Curved solid wood chair with turned legs and a cross-beam structure.
Contoured and padded seat, upholstered in fabric, removable upon request.
- Gebogener Massivholzstuhl mit gedrechselten Beinen und Kreuzträgerstruktur.
Geformter und gepolsterter Sitz mit Stoffbezug. Abnehmbarer Bezug auf Anfrage erhältlich.
- Chaise en bois massif courbé, pieds tournés et structure à entretoises.
Assise profilée et rembourrée, revêtue de tissu. Housse amovible disponible sur demande.

	I E D F	dimensioni dimension abmessungen dimension	spessore thickness stärke épaisseur	volume volume volumen volume	carico ammesso admitted load tragfähigkeit charge admise	peso weight gewicht poids	prezzo price preis prix
		cm	mm	m3	kg	kg	euro

Ekua

62x54 x h73

0,42

12

design Massimo Castagna 2026

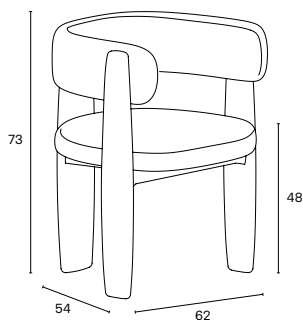

**ORDINE MINIMO N. 4 SEDIE / MINIMUM ORDER N. 4 CHAIRS
MINDESTBESTELLUNG N.4 STÜHLE / COMMANDE MINIMUM N. 4 CHAISES**

FINITURA STRUTTURA / STRUCTURE FINISH STRUKTURAUSFÜHRUNG / FINITION STRUCTURE	SEDUTA-SCHIENALE / SEAT-BACKREST / SITZ-SITZLEHNE / ASSISE-DOSSIER TESSUTO / FABRIC / STOFF / TISSU					
	C	P	H	F	B	D
laccato nero poro aperto / open grain black lacquered offenporig schwarz lackiert / laque noir pores ouverts	1.150	1.160	1.210	1.250	1.300	1.320
rovere naturale / natural oak natur eiche / rouvre naturel	1.175	1.185	1.235	1.275	1.325	1.345
siberian ash / eucalipto	1.170	1.180	1.230	1.270	1.320	1.340

Seduta sfoderabile/removable seat cover/abziehbarer Bezug der Sitzfläche/revêtement siège déhoussable **80**

Versione imbottitura ignifuga/fireproof upholstery version/ Version feuerhemmende Polsterung/version rembourrage ignifuge **100**

**Finiture tessuti vedi catalogo
Fabric finishes see catalogue
Stoffausführungen siehe Katalog
Finitions tissus voir catalogues**

**Per informazioni su eventuale tessuto cliente rivolgersi all'ufficio vendite per prezzo e metraggi.
For information on possible custom fabrics contact sales office for price and length.
Für Informationen bezüglich personalisierter Stoffe bitte wenden Sie sich an unser Verkaufsbüro für Preise und Maße.
Pour information sur tissus personnalisés contactez notre bureau de vente pour prix et métrage.**

- Sedia con struttura a tre gambe in legno massello tornito e traversi incrociati.
Seduta e schienale sagomati e imbottiti, rivestiti in tessuto. Seduta sfoderabile su richiesta.
- Chair with three-legged frame in turned solid wood and cross-beam structure.
Contoured and padded seat and backrest, upholstered in fabric; removable seat covers available upon request.
- Stuhl mit dreibeinigem Gestell aus gedrechseltem Massivholz und Kreuzträgerstruktur.
Konturierte und gepolsterte Sitzfläche und Rückenlehne, bezogen mit Stoff. Abnehmbarer Sitzbezug auf Anfrage erhältlich.
- Chaise à trois pieds en bois massif tourné et traverses croisées.
Assise et dossier profilés et rembourrés, revêtus de tissu.
Housse d'assise amovible disponible sur demande.

	I E D F	dimensioni dimension abmessungen dimension	spessore thickness stärke épaisseur	volume volume volumen volume	carico ammesso admitted load tragfähigkeit charge admise	peso weight gewicht poids	prezzo price preis prix
		cm	mm	m3	kg	kg	euro

Mit

48 x 50 x h 78

0,36

10

design Massimo Castagna 2024

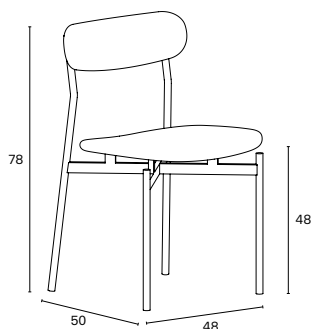

**ORDINE MINIMO N. 4 SEDIE / MINIMUM ORDER N. 4 CHAIRS
MINDESTBESTELLUNG N.4 STÜHLE / COMMANDE MINIMUM N. 4 CHAISES**

FINITURA STRUTTURA / STRUCTURE FINISH STRUKTURAUSFÜHRUNG / FINITION STRUCTURE	SEDUTA-SCHIENALE / SEAT-BACKREST / SITZ-SITZLEHNE / ASSISE-DOSSIER					
VERNICIATA / LACQUERED LACKIERT / LACQUÉE	TESSUTO C FABRIC C STOFF C TISSU C	TESSUTO P FABRIC P STOFF P TISSU P	TESSUTO H FABRIC H STOFF H TISSU H	TESSUTO F FABRIC F STOFF F TISSU F	TESSUTO B FABRIC B STOFF B TISSU B	TESSUTO D FABRIC D STOFF D TISSU D
nero / black / schwarz / noir	560	580	605	610	640	660
champagne o Titanio / champagne or Titanio Champagne roder Titanio / champagne ou Titanio	580	600	625	630	660	680
CROMATO / CHROME CHROM / CHROME						
cromo lucido / polished chrome Chrom glänzend / chrome brilliant	620	640	665	670	700	720
canna di fucile lucido / polished gunmetal Gunmetal glänzend / gunmetal brilliant						

Seduta sfoderabile/removable seat cover/abziehbarer Bezug der Sitzfläche/revêtement siège déhoussable **60**

Versione imbottitura ignifuga/fireproof upholstery version/ Version feuerhemmende Polsterung/version rembourrage ignifuge **80**

**Finiture tessuti vedi catalogo
Fabric finishes see catalogue
Stoffausführungen siehe Katalog
Finitions tissus voir catalogues**

**Per informazioni su eventuale tessuto cliente rivolgersi all'ufficio vendite per prezzo e metraggi.
For information on possible custom fabrics contact sales office for price and length
Für Informationen bezüglich personalisierter Stoffe bitte wenden Sie sich an unser Verkaufsbüro für Preise und Maße
Pour information sur tissus personnalisés contactez notre bureau de vente pour prix et métrage.**

- Sedia con struttura in metallo nelle finiture cromo lucido, canna di fucile lucido oppure verniciata, nero opaco, Champagne o Titanio
Seduta e schienale sagomati, imbottiti e rivestiti in tessuto.
Seduta non sfoderabile. Optional seduta sfoderabile.
- Chair with metal structure in finishes polished chrome, polished gunmetal or lacquered, matt black, Champagne or Titanio.
Shaped seat and backrest, upholstered and covered in fabric.
Covering not removable. Optional removable seat covering.
- Stuhl mit Metallstruktur in Ausführung Chrom glänzend, Gunmetal glänzend oder lackiert: mat schwarz, Champagnerfarbe oder Titanio.
Sitz und Rücklehne profiliert, gepolstert und mit Stoff überzogen.
Stoff nicht abziehbar. Optional abziehbarer Sitzbezug.
- Chaise avec structure en métal en finition chrome brillant, gumetal brillant ou laqué: noir mat, Champagne ou Titanio.
Assise et dos profilés, rembourrés et revêtu en tissu.
Tissue pas déhoussable. Optionnelle assise déhoussable.

	I E D F	dimensioni dimension abmessungen dimension	spessore thickness stärke épaisseur	volume volume volumen volume	carico ammesso admitted load tragfähigkeit charge admise	peso weight gewicht poids	prezzo price preis prix
		cm	mm	m3	kg	kg	euro

Sanur

59x59xh71

0,4

7

design Giovanni D'Ambrosio 2026

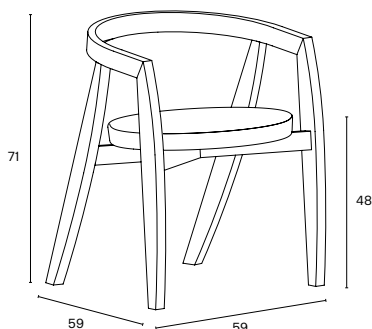

**ORDINE MINIMO N. 4 SEDIE / MINIMUM ORDER N. 4 CHAIRS
MINDESTBESTELLUNG N.4 STÜHLE / COMMANDE MINIMUM N. 4 CHAISES**

FINITURA STRUTTURA / STRUCTURE FINISH STRUKTURAUSFÜHRUNG / FINITION STRUCTURE	SEDUTA / SEAT / SITZ / ASSISE TESSUTO / FABRIC / STOFF / TISSU					
	C	P	H	F	B	D
laccato nero poro aperto / open grain black lacquered offenporig schwarz lackiert / laque noir pores ouverts	765	785	810	815	845	865
rovere naturale / natural oak natur eiche / rouvre naturel	790	810	835	840	870	890
siberian ash / eucalipto	785	805	830	835	865	885

Seduta sfoderabile/removable seat cover/abziehbarer Bezug der Sitzfläche/revêtement siège déhoussable **60**

Versione imbottitura ignifuga/fireproof upholstery version/ Version feuerhemmende Polsterung/version rembourrage ignifuge **80**

**Finiture tessuti vedi catalogo
Fabric finishes see catalogue
Stoffausführungen siehe Katalog
Finitions tissus voir catalogues**

**Per informazioni su eventuale tessuto cliente rivolgersi all'ufficio vendite per prezzo e metraggi.
For information on possible custom fabrics contact sales office for price and length.
Für Informationen bezüglich personalisierter Stoffe bitte wenden Sie sich an unser Verkaufsbüro für Preise und Maße.
Pour information sur tissus personnalisés contactez notre bureau de vente pour prix et métrage.**

- Sedia in legno massello curvato con gambe inclinate e struttura a traversi incrociati.
Seduta sagomata e imbottita, rivestita in tessuto. Sfoderabile su richiesta.
- Chair in curved solid wood with slanted legs and a cross-beam structure.
Contoured and padded seat, upholstered in fabric, removable upon request.
- Gebogener Massivholzstuhl mit schrägen Beinen und Kreuzträgerstruktur.
Konturierter, gepolsterter Sitz mit Stoffbezug. Abnehmbarer Bezug auf Anfrage erhältlich.
- Chaise en bois massif courbé, avec pieds inclinés et structure à entretoises croisées.
Assise profilée et rembourrée, revêtue de tissu. Housse amovible disponible sur demande

	I E D F	dimensioni dimension abmessungen dimension	spessore thickness stärke épaisseur	volume volume volumen volume	carico ammesso admitted load tragfähigkeit charge admise	peso weight gewicht poids	prezzo price preis prix
		cm	mm	m3	kg	kg	euro

She

53x56xh 80

0,404

11

design Massimo Castagna 2021

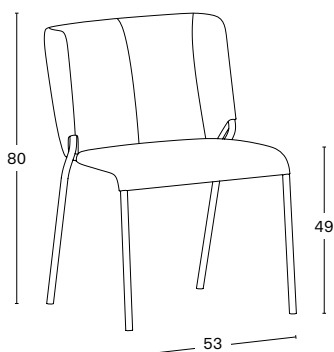

**ORDINE MINIMO N. 4 SEDIE / MINIMUM ORDER N. 4 CHAIRS
MINDESTBESTELLUNG N.4 STÜHLE / COMMANDE MINIMUM N. 4 CHAISES**

FINITURA STRUTTURA / STRUCTURE FINISH STRUKTURAUSFÜHRUNG / FINITION STRUCTURE	SEDUTA-SCHIENALE / SEAT-BACKREST / SITZ-SITZLEHNE / ASSISE-DOSSIER			
VERNICIATA / LACQUERED LACKIERT / LACQUÉE	TESSUTO P FABRIC P STOFF P TISSU P	TESSUTO F FABRIC F STOFF F TISSU F	TESSUTO D FABRIC D STOFF D TISSU D	PELLE LEATHER LEDER CUIR
nero / black / schwarz / noir grigio antracite / anthracite grey / Anthrazit grau / gris anthracite bianco / white / weiß / blanc champagne / champagne / Champagne / champagne	830	860	910	970
CROMATO / CHROME CHROM / CHROME				
cromo lucido / polished chrome Chrom glänzend / chrome brilliant	840	870	920	980
canna di fucile lucido / polished gunmetal Gunmetal glänzend / gunmetal brillant	850	880	930	990

**Finiture pelle e tessuti vedi catalogo
Leather and fabrics finishes see catalogue
Verfügbare Leder und Stoffe siehe Katalog
Finitions cuir et tissus voir catalogues**

Versione ignifuga/fireproof version/feuerhemmende Version/version ignifuge

160

- Sedia con struttura in tubolare da 20 mm in finiture cromo lucido, canna di fucile lucido, Champagne o verniciate gofrato opaco. Sedile e schienale imbottito, rivestito in pelle o tessuto **F - P - D**. Sedia non sfoderabile.
- chair with 20 mm tubular structure in polished chrome, polished gunmetal, Champagne or matt embossed lacquered finish. Upholstered seat and backrest in leather or fabric **F - P - D**. Covering not removable.
- Stuhl mit 20 mm rohrförmigen Struktur in Ausführung Chrom glänzend, Gunmetal glänzend, Champagnerfarbe oder matt eingepprägter Lackierung. Gepolsterter Sitz und Sitzlehne aus Leder, oder Stoffbezug **F - P - D**. Stuhlbeleidung nicht abziehbar.
- chaise avec structure tubulaire en 20 mm en finitions chrome brillant, gunmetal brillant, Champagne ou laqué mat gaufré. Assise et dossier rembourrés en cuir ou tissu **F - P - D**. Chaise pas déhoussable.

lampade | lamps

	I	dimensioni	spessore	volume	carico ammesso	peso	prezzo
	E	dimension	thickness	volume	admitted load	weight	price
	D	abmessungen	stärke	volumen	tragfähigkeit	gewicht	preis
	F	dimension	épaisseur	volume	charge admise	poids	prix
		cm	mm	m3	kg	kg	euro
Cathedral design Studio 14 2025	A	28 x 28 x h 70		0,20		14	2.270
	B	46 x 46 x h 50		0,30		18	2.830
	C	76 x 76 x h 30		0,46		20	3.120

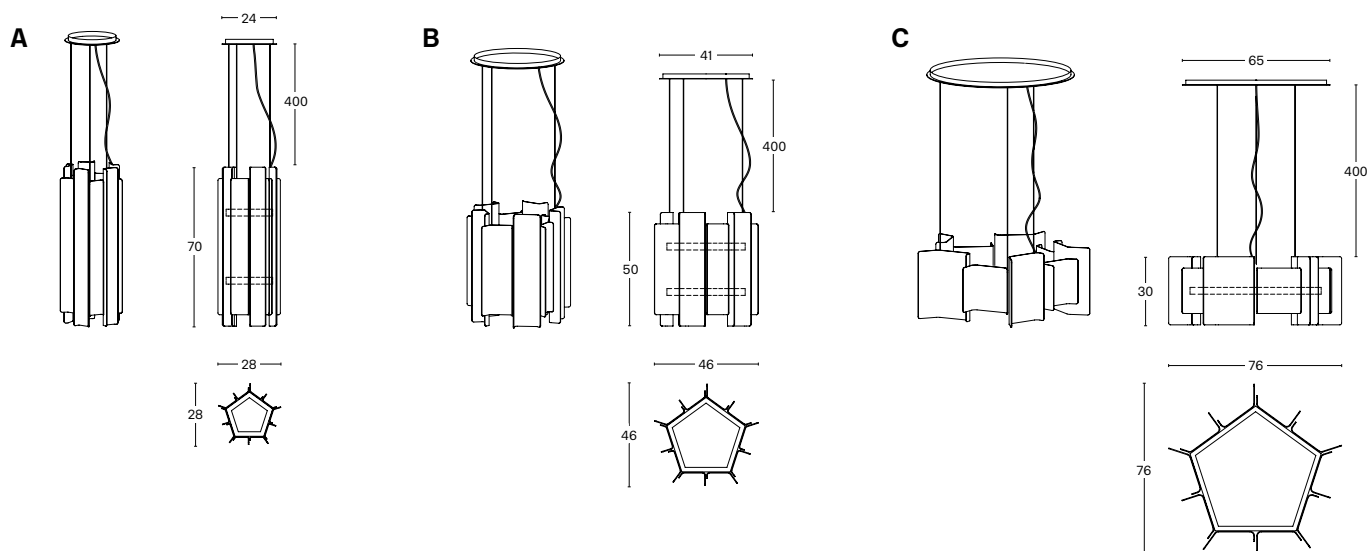

Lampada / Lamp / Lampe / Lampe	lm / Lumen
A	1750
B	3000
C	2500
A + B	4750
B + C	5500
A + B + C	7250

specificare sempre la finitura delle parti in vetro e in metallo
always specify finish glass and metal parts
immer Ausführung der Glas- und Metallteile angeben
toujours spécifier finition des parts en verre et en métal

specificare il paese di destinazione
specify country of destination
immer Zielland angeben
toujours indiquer pays de destination

- Lampada a sospensione a luce LED dimmerabile 3000K, in vetro fuso fumè o bronzo e metallo in finitura champagne o Titanio. Il rosone è sempre in abbinamento alla finitura del metallo. Cavi di sospensione in acciaio, regolabili in altezza fino a 4 metri. Trasformatore già predisposto per impianti di domotica DALI.
- Hanging lamp with dimmable 3000K LED lights, in smoked or bronze fused glass and metal in champagne or Titanio finish. The canopy is always combined to the metal finish. Suspension cable in steel, adjustable up to 4 meters. Driver already predisposed for DALI domotic systems.
- Hängelampe mit 3000K dimmbare Led Beleuchtung, aus geschmolzenem Rauchglas oder Bronze Glas und Metall in Ausführung Champagne oder Titanio. Deckenrosette immer mit Metallausführung kombiniert. Hängekabel aus Stahl, regulierbar bis zu 4 Meter. Trafo bereits für DALI Domotic System vorgesehen.
- Lampe à suspension avec lumière LED gradables 3000K, en verre en fusion fumé ou bronze et métal en finition champagne ou Titanio. Rosette toujours en combinaison avec la finition du métal. Câbles de suspension en acier, réglables jusqu'à 4 mètres. Transformateur déjà prédisposé pour les systèmes domotique DALI.

	I	dimensioni	spessore	volume	carico ammesso	peso	prezzo
	E	dimension	thickness	volume	admitted load	weight	price
	D	abmessungen	stärke	volumen	tragfähigkeit	gewicht	preis
	F	dimension	épaisseur	volume	charge admise	poids	prix
		cm	mm	m3	kg	kg	euro

Cathedral	A+B 46x46xh 70 / 85	0,50		29	5.100
	B+C 76x76xh 50	0,76		34	5.950
	A+B+C 76x76xh 70 / 85	0,96		45	8.220

Esempi di composizioni / Composition examples / Kompositionbeispiele / Exemples de composition

A+B

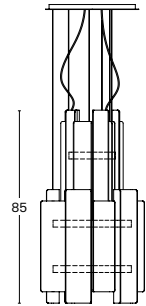
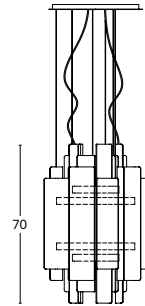
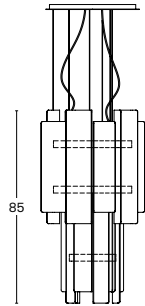
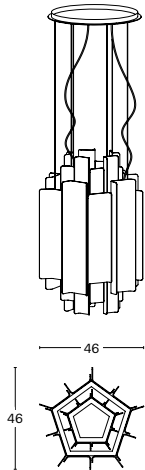

B+C

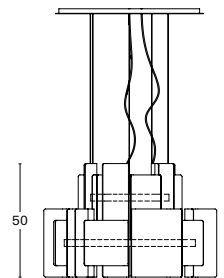
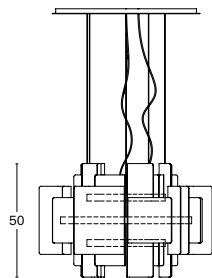
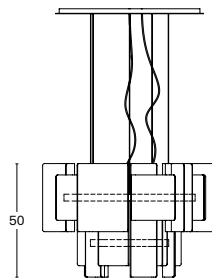
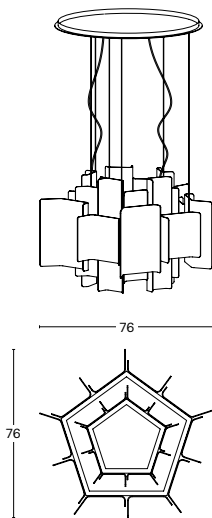

A+B+C

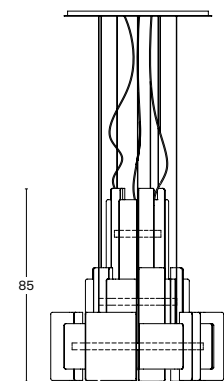
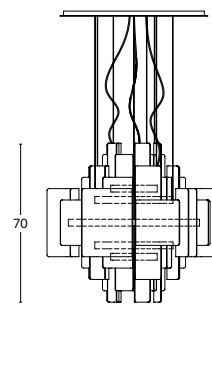
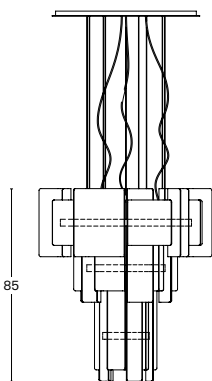
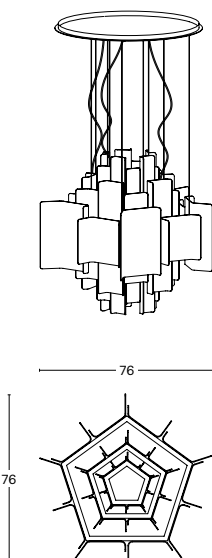

	I	dimensioni	spessore	volume	carico ammesso	peso	prezzo
	E	dimension	thickness	volume	admitted load	weight	price
	D	abmessungen	stärke	volumen	tragfähigkeit	gewicht	preis
	F	dimension	épaisseur	volume	charge admise	poids	prix
		cm	mm	m3	kg	kg	euro

Hyperion design Massimo Castagna 2020	A	75 x 74 x h 130		0,62		16	2.780
	B	60 x 60 x h 122		0,27		15	2.970
							2.360
							2.510

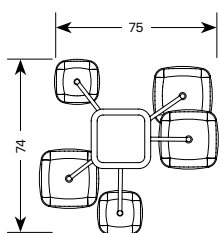
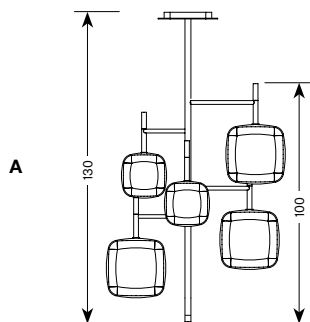

- Lampadine dimmerabili **G9 3000K 4/5 max 5W 2000/2500 lm.**
Dimmable bulbs **G9 3000K 4/5 max 5W 2000/2500 lm.**
Dimmbare Birnen **G9 3000K 4/5 max 5W 2000/2500lm.**
Ampoules gradables **G9 3000K 4/5 max 5W 2000/2500lm.**

Supplemento per altezza su misura da > a Upcharge for custom height from > to Aufpreis für Sonderhöhe von > bis Supplément pour hauteur sur mesure de > à	
110 > 121/129	120
123/131 > 160	160
161 > 200	200
201 > 250	270
251 > 300	340
301 > 350	410
351 > 400	480
401 > 450	550
451 > 500	620
501 > 550	690
551 > 600	760

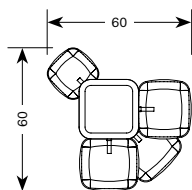
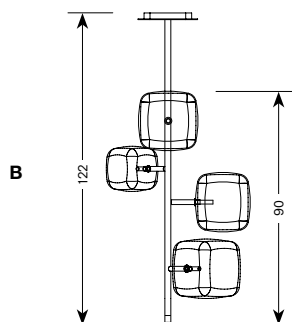

specificare sempre la finitura del telaio in metallo
always specify finish of metal frame
immer Ausführung des Metallgestell angeben
toujours spécifier finition de l'armature en métal

specificare il paese di destinazione
specify country of destination
immer Zielland angeben
toujours indiquer pays de destination

- Lampada a sospensione a luce LED, 4 o 5 cubi in vetro pyrex soffiato trasparente. Lampadine dimmerabili G4 3000K 4/5 x max 4W 1200/1500lm. Parti metalliche disponibili nelle finiture cromo lucido, oro lucido, canna di fucile lucido e champagne.
L'altezza può essere realizzata a misura, da un minimo di 110 cm ad un massimo di 600 cm totali.
- Hanging lamp with LED lights, 4 or 5 transparent blown pyrex glass cubes. Dimmable bulbs G4 3000K 4/5 x max 4W 1200/1500lm. Metal parts available in polished chrome, polished gold, polished gunmetal and champagne finish. Custom height available, from minimum 110cm to maximum 600 cm total.
- Hängelampe mit Led Beleuchtung, 4 oder 5 Würfel aus transparentem geblasenem Pyrex Glas. Dimmbare Birnen G4 3000K 4/5 x max 4W 1200/1500lm. Metallteile erhältlich in Chrom glänzend, gold glänzend, Gunmetal glänzend und Champagne. Die Höhe kann auf Maß gefertigt werden, von mindestens 110 cm bis maximal 600 cm insgesamt.
- Lampe à suspension avec lumière LED, 4 ou 5 cubes en verre soufflé pyrex transparent. Ampoules gradables G4 3000K 4/5 x max 4W 1200/1500lm. Parts en métal disponible en finition chrome brillant, or brillant, gunmetal brillant et champagne. Hauteur disponible sur mesure, de minimum 110cm à maximum 600 cm total.

Su richiesta è disponibile, già cablato nelle lampade, il sistema di alimentazione per impianti di domotica **DALI 1** e **DALI 2**. Per informazioni e costi rivolgersi al ns. ufficio vendite.

Available on request, already wired in the lamps, power supply system for home automation system **DALI 1** and **DALI 2**. For information and pricing contact our sales office.

Verfügbar nach Anfrage, bereits in den Lampen verkabelt, Stromversorgung für Domotik System **DALI 1** und **DALI 2**. Für Informationen und Preise unser Verkaufsbüro Kontaktieren.

Disponibile sur demande, déjà câblé dans les lampes, système d'alimentation pour système domotique **DALI 1** et **DALI 2**. Pour information et prix contacter notre bureau de ventes.

	I	dimensioni	spessore	volume	carico ammesso	peso	prezzo
	E	dimension	thickness	volume	admitted load	weight	price
	D	abmessungen	stärke	volumen	tragfähigkeit	gewicht	preis
	F	dimension	épaisseur	volume	charge admise	poids	prix
		cm	mm	m3	kg	kg	euro

Hyperion design Massimo Castagna 2020	C	19 x 19 x h 49		0,030		6	580
	D	25 x 25 x h 62		0,065		7	660

Il trasformatore va sempre posizionato nel controsoffitto o all'interno della scatola di derivazione.
The transformer must always be placed in the false ceiling or inside the junction box.
Der Trafo muss immer in die Zwischendecke platziert werden oder in der Anschlussdose.
Le transformateur doit être toujours placé dans le faux plafond ou le boîtier de jonction.

specificare sempre la finitura del telaio in metallo
always specify finish of metal frame
immer Ausführung des Metallgestell angeben
toujours spécifier finition de l'armature en métal

specificare il paese di destinazione
specify country of destination
immer Zielland angeben
toujours indiquer pays de destination

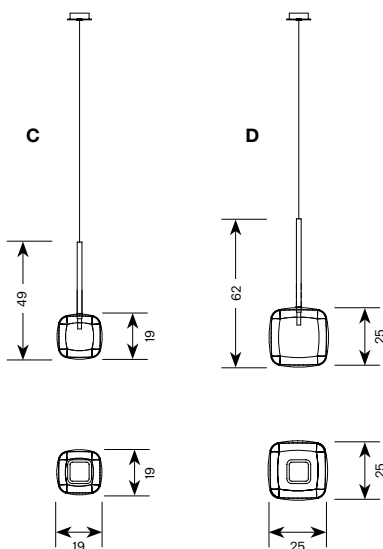

- Lampada a sospensione a luce LED, Cubo in vetro pyrex soffiato trasparente. Lampadina dimmerabile 4G 3000K max 4W 300lm. Parti metalliche disponibili nelle finiture cromo lucido, oro lucido, canna di fucile lucido e champagne. In dotazione cavo da 4 mt.
- Hanging lamp with LED lights, cube in transparent blown pyrex glass. Dimmable bulb 4G 3000K max 4W 300lm. Metal parts available in polished chrome, polished gold, polished gunmetal and champagne finish. Supplied with 4 mt long cable.
- Hängelampe mit Led Beleuchtung, Würfel aus transparentem geblasenem Pyrex Glas. Dimmbare Birne 4G 3000K max 4W 300lm. Metallteile erhältlich in Chrom glänzend, gold glänzend, Gunmetal glänzend und Champagner. Wird mit 4m langem Kabel geliefert.
- Lampe à suspension avec lumière LED, cube en verre soufflé pyrex transparent. Ampoule gradable 4G 3000K max 4W 300lm. Parts en métal disponible en finition chrome brillant, or brillant, gunmetal brillant et champagne. En dotation cable de 4 mt.

Hyperion design Massimo Castagna 2024	H	135 x 67 x h 64		0,32		25	3.680
							● 3.980

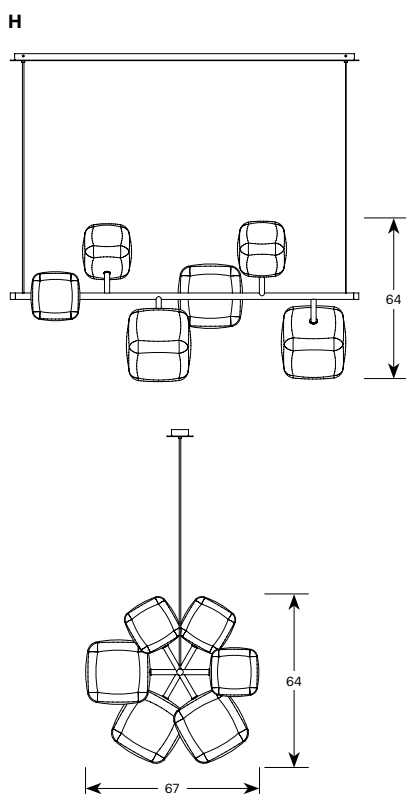

- Lampadine dimmerabili **G9** 3000K 6 max 5W 3000 lm.
Dimmable bulbs **G9** 3000K 6 max 5W 3000 lm.
Dimmbare Birnen **G9** 3000K 6 max 5W 3000 lm.
Ampoules gradables **G9** 3000K 6 max 5W 3000 lm.

specificare sempre la finitura del telaio in metallo
always specify finish of metal frame
immer Ausführung des Metallgestell angeben
toujours spécifier finition de l'armature en métal

specificare il paese di destinazione
specify country of destination
immer Zielland angeben
toujours indiquer pays de destination

- Lampada a sospensione orizzontale a luce LED, 6 cubi in vetro pyrex trasparente. Lampadine dimmerabili G4 3000K 6 Max 4W 1800lm. Parti metalliche disponibili nelle finiture cromo lucido, oro lucido, canna di fucile lucido e champagne. Cavi di sospensione in acciaio, regolabili in altezza fino a 4 metri.
- Horizontal hanging lamp with LED lighting, 6 cubes in transparent Pyrex glass. Dimmable bulbs G4 3000 K 6 Max 4W 1800lm. Metal parts available in finish polished chrome, polished gold, polished gunmetal and champagne. Suspension cables in steel, adjustable in height up to 4 meters.
- Waagrechte Hängelampe mit LED-Licht. 6 Würfel aus transparentem Pyrex Glas. Dimmbare Birnen G4 3000K 6 Max 4W 1800lm. Metallteile erhältlich in Ausführung Chrom glänzend, Gold glänzend, Gunmetal glänzend, oder Champagner. Tragseilen aus Stahl in Höhe regulierbar bis zu 4 Meter.
- Lampe à suspension horizontale avec lumière LED. 6 cubes en verre pyrex transparent. Ampoules gradables G4 3000 K 6 Max 4W 1800lm. Parts métalliques disponibles en finition chrome brillant, or brillant, gunmetal brillant ou champagne. Câbles de suspension en acier réglables en hauteur jusqu'à quatre mètres.

	I E D F	dimensioni dimension abmessungen dimension	spessore thickness stärke épaisseur	volume volume volumen volume	carico ammesso admitted load tragfähigkeit charge admise	peso weight gewicht poids	prezzo price preis prix
		cm	mm	m3	kg	kg	euro

Hyperion	E	60 x 60 x h 180		0,58		19	2.280
design Massimo Castagna 2020							

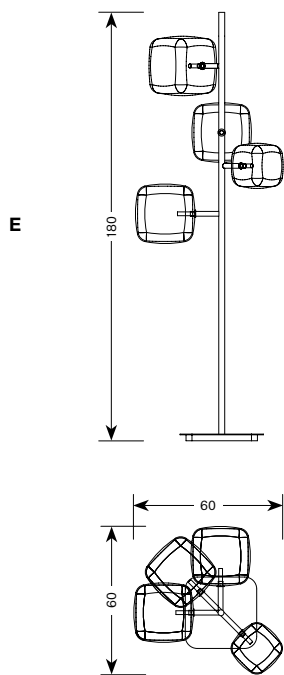

specificare sempre la finitura del telaio in metallo
always specify finish of metal frame
immer Ausführung des Metallgestell angeben
toujours spécifier finition de l'armature en métal

specificare il paese di destinazione
specify country of destination
immer Zielland angeben
toujours indiquer pays de destination

- Lampada da terra a luce LED, 4 cubi in vetro pyrex soffiato trasparente. Lampadine dimmerabili G4 3000K 4 x max 4W 1200lm. Parti metalliche disponibili nelle finiture cromo lucido, oro lucido, canna di fucile lucido e champagne.
- Floor lamp with LED lights, 4 cubes in transparent blown pyrex glass. Dimmable bulbs G4 3000K 4 x max 4W 1200lm. Metal parts available in polished chrome, polished gold, polished gunmetal and champagne finish.
- Stehlampe mit LED Beleuchtung, 4 Würfel aus transparentem geblasenem Pyrex Glas. Dimmbare Birnen G4 3000K 4 x max 4W 1200lm. Metallteile erhältlich in Chrom glänzend, gold glänzend, Gunmetal glänzend und Champagner.
- Lampadaire avec lumière LED (H1,5W - led (G4) 180 lm, 3000K). 4 cubes en verre soufflé pyrex transparent. Ampoules gradables G4 3000K 4 x max 4W 1200lm. Parts en métal disponible en finition chrome brillant, or brillant, gunmetal brillant et champagne.

Hyperion	F	23 x 23 x h 39		0,089		5	690
	G	30 x 30 x h 34		0,107		7	750
design Massimo Castagna 2021							

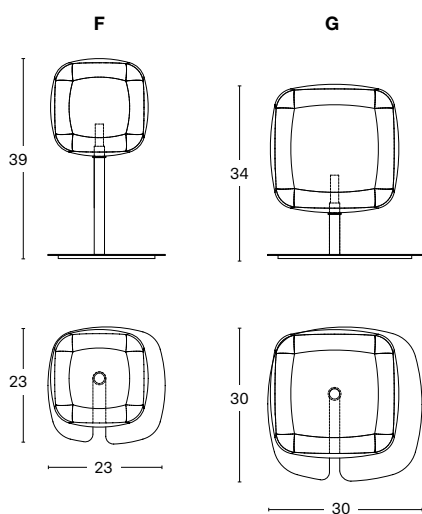

specificare sempre la finitura del telaio in metallo
always specify finish of metal frame
immer Ausführung des Metallgestell angeben
toujours spécifier finition de l'armature en métal

specificare il paese di destinazione
specify country of destination
immer Zielland angeben
toujours indiquer pays de destination

- Lampada da tavolo a luce LED, cubo in vetro pyrex soffiato trasparente. Lampadina dimmerabile G9 3000K max 2,5W 200lm. Parti metalliche disponibili nelle finiture cromo lucido, oro lucido, canna di fucile lucido e champagne.
- Table lamp with LED lights, cube in transparent blown pyrex glass. Dimmable bulb G9 3000K max 2,5W 200lm. Metal parts available in polished chrome, polished gold, polished gunmetal finish and champagne finish.
- Tischlampe mit Led Beleuchtung, Würfel aus transparentem geblasenem Pyrex Glas. Dimmbare Birne G9 3000K max 2,5W 200lm. Metallteile erhältlich in Chrom glänzend, gold glänzend, Gunmetal glänzend und Champagner.
- Lampe de bureau avec lumière LED, cube en verre soufflé pyrex transparent. Ampoule gradable G9 3000K max 2,5W 200lm. Parts en métal disponible en finition chrome brillant, or brillant, gunmetal brillant et champagne.

	I	dimensioni	spessore	volume	carico ammesso	peso	prezzo
	E	dimension	thickness	volume	admitted load	weight	price
	D	abmessungen	stärke	volumen	tragfähigkeit	gewicht	preis
	F	dimension	épaisseur	volume	charge admise	poids	prix
		cm	mm	m3	kg	kg	euro

Hyperion applique

19 x 28 x h 36

0,04

4

780

● 790

design Massimo Castagna 2025

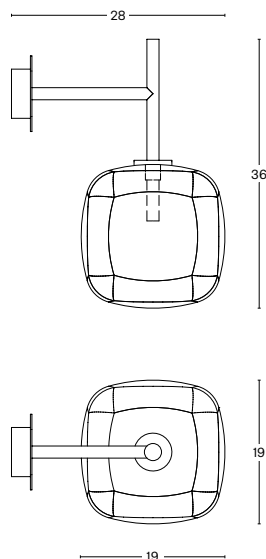

**Il trasformatore va sempre posizionato nel controsoffitto o all'interno della scatola di derivazione.
The transformer must always be placed in the false ceiling or inside the junction box.
Der Trafo muss immer in die Zwischendecke platziert werden oder in der Anschlussdose.
Le transformateur doit être toujours placé dans le faux plafond ou le boîtier de jonction.**

- Lampadine dimmerabili **G9** 500K max 5W 500 lm.
Dimmable bulbs **G9** 500K max 5W 500 lm.
Dimmbare Birnen **G9** 500K max 5W 500 lm.
Ampoules gradables **G9** 500K max 5W 500 lm.

**specificare sempre la finitura del telaio in metallo
always specify finish of metal frame
immer Ausführung des Metallgestell angeben
toujours spécifier finition de l'armature en métal**

specificare il paese di destinazione
specify country of destination
immer Zielland angeben
toujours indiquer pays de destination

- Applique a luce LED, Cubo in vetro pyrex soffiato trasparente.
Lampadina dimmerabile G4 3000K max 4W 300lm.
Parti metalliche disponibili nelle finiture cromo lucido, oro lucido, canna di fucile lucido e champagne.
- Applique with LED lights, cube in transparent blown pyrex glass.
Dimmable bulb G4 3000K max 4W 300lm.
Metal parts available in polished chrome, polished gold, polished gunmetal and champagne finish.
- Wandlampe mit Led Beleuchtung, Würfel aus transparentem geblasenem Pyrex Glas.
Dimmbare Birne G4 3000K max 4W 300lm.
Metallteile erhältlich in Chrom glänzend, gold glänzend, Gunmetal glänzend und Champagner.
- Applique avec lumière LED, cube en verre soufflé pyrex transparent.
Ampoule gradable G4 3000K max 4W 300lm.
Parts en métal disponible en finition chrome brillant, or brillant, gunmetal brillant et champagne.

	I	dimensioni	spessore	volume	carico ammesso	peso	prezzo
	E	dimension	thickness	volume	admitted load	weight	price
	D	abmessungen	stärke	volumen	tragfähigkeit	gewicht	preis
	F	dimension	épaisseur	volume	charge admise	poids	prix
		cm	mm	m3	kg	kg	euro

Noum S design Massimo Castagna 2022	S90 56 x7xh 90	0,27	8	910
	S120 56 x7xh120	0,27	10	980

S90

S120

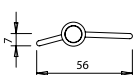
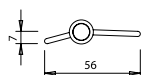
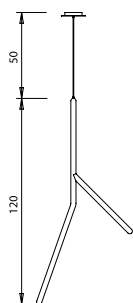
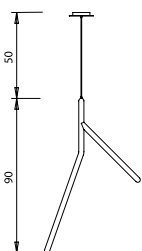

Maggiorazione per impianto dimmerabile
Surcharge for dimmer system
Aufpreis für Dimmer System.
Augmentation pour système gradable.

90

specificare sempre la finitura della struttura in legno SIBERIAN ASH, EUCALIPTO o ROVERE NATURALE
always specify finish of wooden structure SIBERIAN ASH, EUCALIPTO OR NATURAL OAK
immer Ausführung der Holzstruktur angeben SIBERIAN AHS, EUCALIPTO ODER EICHE NATUR
toujours spécifier finition de la structure en bois SIBERIAN ASH, EUCALIPTO OU ROUVRE NATUREL

specificare il paese di destinazione
specify country of destination
immer Zielland angeben
toujours indiquer pays de destination

- Lampada a sospensione in legno massello in finitura SIBERIAN ASH, EUCALIPTO o ROVERE NATURALE. Impianto di illuminazione a luce LED COB 13W 1200LM, non dimmerabile. Cavo di sospensione nero in dotazione fino a 1,5mt.
- Hanging lamp in solid wood in finish SIBERIAN ASH, EUCALIPTO OR NATURAL OAK. Lighting system with LED COB 13W 1200LM 3000°K, not dimmable. Provided with suspension cable up to 1,5mt.
- Hängelampe aus Massivholz in Ausführung SIBERIAN ASH, EUCALPTO ODER EICHE NATUR. Leuchtsystem mit LED COB 13W 1200LM 3000°K, nicht dimmbar. Inkl. Hängekabel bis zu 1,5mt.
- Lampe à suspension en bois massif en finition SIBERIAN ASH, EUCALIPTO OU ROUVRE NATUREL. Système d'illumination avec LED COB 13W 1200LM 3000°K, non gradable. Cable de suspension jusqu'à 1,5mt inclus.

Noum XL design Massimo Castagna 2022	XL90 59 x24 xh 90	0,27	15	1.840
	XL120 59 x24 xh 120	0,27	19	1.980

XL90

XL120

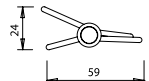
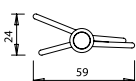
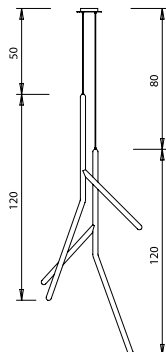
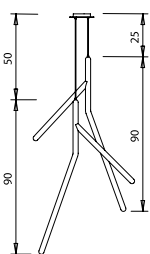

Maggiorazione per impianto dimmerabile
Surcharge for dimmer system
Aufpreis für Dimmer System.
Augmentation pour système gradable.

90

specificare sempre la finitura della struttura in legno SIBERIAN ASH, EUCALIPTO o ROVERE NATURALE
always specify finish of wooden structure SIBERIAN ASH, EUCALIPTO OR NATURAL OAK
immer Ausführung der Holzstruktur angeben SIBERIAN AHS, EUCALIPTO ODER EICHE NATUR
toujours spécifier finition de la structure en bois SIBERIAN ASH, EUCALIPTO OU ROUVRE NATUREL

specificare il paese di destinazione
specify country of destination
immer Zielland angeben
toujours indiquer pays de destination

- Lampada a sospensione a due elementi con rosone unico in legno massello in finitura SIBERIAN ASH, EUCALIPTO o ROVERE NATURALE. Impianto di illuminazione a luce LED COB 26W 2400LM, non dimmerabile. Cavo di sospensione nero in dotazione fino a 1,5mt.
- Hanging lamp with two elements and one ceiling rose in solid wood in finish SIBERIAN ASH, EUCALIPTO OR NATURAL OAK. Lighting system with LED COB 26W 2400LM, not dimmable. Provided with black suspension cable up to 1,5mt.
- Hängelampe mit zwei Elementen und einziger Deckenrosette aus Massivholz in Ausführung SIBERIAN ASH, EUCALPTO ODER EICHE NATUR. Leuchtsystem mit LED COB 26W 2400LM, nicht dimmbar. Inkl. schwarzer Hängekabel bis zu 1,5mt.
- Lampe à suspension avec deux éléments et une seule rose en bois massif SIBERIAN ASH, EUCALIPTO OU ROUVRE NATUREL. Système d'illumination avec LED COB 26W 2400LM, non gradable. Cable de suspension jusqu'à 1,5mt inclus.

	I	dimensioni	spessore	volume	carico ammesso	peso	prezzo
	E	dimension	thickness	volume	admitted load	weight	price
	D	abmessungen	stärke	volumen	tragfähigkeit	gewicht	preis
	F	dimension	épaisseur	volume	charge admise	poids	prix
		cm	mm	m3	kg	kg	euro

Noum XXL design Massimo Castagna 2024	XXL90 87 x 30 x h 90			0,27		30	3.720
	XXL120 87 x 30 x h 120			0,27		38	3.960

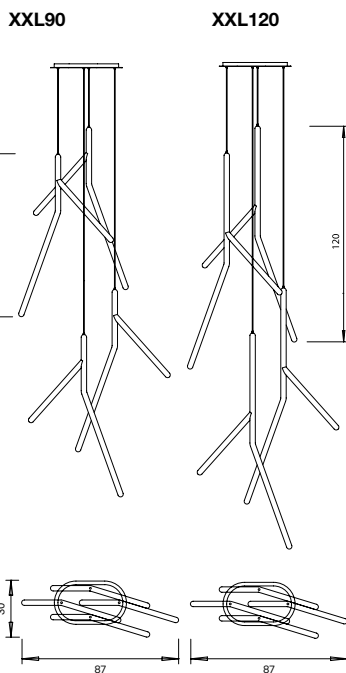

Maggiorazione per impianto dimmerabile
Surcharge for dimmer system
Aufpreis für Dimmer System.
Augmentation pour système gradable.

120

specificare sempre la finitura della struttura in legno SIBERIAN ASH, EUCALIPTO o ROVERE NATURALE
always specify finish of wooden structure SIBERIAN ASH, EUCALIPTO OR NATURAL OAK
immer Ausführung der Holzstruktur angeben SIBERIAN AHS, EUCALIPTO ODER EICHE NATUR
toujours spécifier finition de la structure en bois SIBERIAN ASH, EUCALIPTO OU ROUVRE NATUREL

specificare il paese di destinazione
specify country of destination
immer Zielland angeben
toujours indiquer pays de destination

- Lampada a sospensione a quattro elementi con rosone unico in legno massello in finitura SIBERIAN ASH, EUCALIPTO o ROVERE NATURALE. Impianto di illuminazione a luce LED COB 26W 2400LM, non dimmerabile. Cavo di sospensione nero in dotazione fino a 1,5mt.
- Hanging lamp with four elements and one ceiling rose in solid wood in finish SIBERIAN ASH, EUCALIPTO OR NATURAL OAK. Lighting system with LED COB 26W 2400LM, not dimmable. Provided with black suspension cable up to 1,5mt.
- Hängelampe mit Vier Elementen und einziger Deckenrosette aus Massivholz in Ausführung SIBERIAN ASH, EUCALPTO ODER EICHE NATUR. Leuchtsystem mit LED COB 26W 2400LM, nicht dimmbar. Inkl. schwarzer Hängekabel bis zu 1,5mt.
- Lampe à suspension avec quatre éléments et une seule rose en bois massif SIBERIAN ASH, EUCALIPTO OU ROUVRE NATUREL. Système d'illumination avec LED COB 26W 2400LM, non gradable. Cable de suspension jusqu'à 1,5mt inclus.

Noum M design Massimo Castagna 2022	M90 56 x 7 x h 90			0,27		9	990
	M120 56 x 7 x h 120			0,27		11	1.060

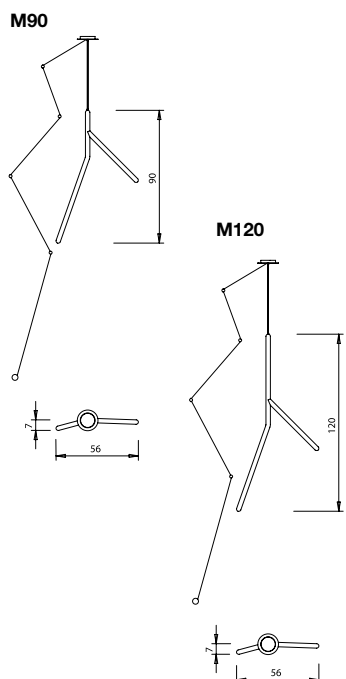

Maggiorazione per impianto dimmerabile
Surcharge for dimmer system
Aufpreis für Dimmer System.
Augmentation pour système gradable.

90

specificare sempre la finitura della struttura in legno SIBERIAN ASH, EUCALIPTO o ROVERE NATURALE
always specify finish of wooden structure SIBERIAN ASH, EUCALIPTO OR NATURAL OAK
immer Ausführung der Holzstruktur angeben SIBERIAN AHS, EUCALIPTO ODER EICHE NATUR
toujours spécifier finition de la structure en bois SIBERIAN ASH, EUCALIPTO OU ROUVRE NATUREL

specificare il paese di destinazione
specify country of destination
immer Zielland angeben
toujours indiquer pays de destination

- Lampada a sospensione in legno massello in finitura SIBERIAN ASH, EUCALIPTO o ROVERE NATURALE. Impianto di illuminazione a luce LED COB 13W 1200LM 3000°K, non dimmerabile. In dotazione cavo di sospensione fino a 5mt. predisposto per alimentazione da presa a muro e n. 05 ferma cavo di colore nero per fissaggio alla parete.
- Hanging lamp in solid wood in finish SIBERIAN ASH, EUCALIPTO OR NATURAL OAK. Lighting system with LED COB 13W 1200LM 3000°K, not dimmable. Provided with suspension cable up to 5mt, set up for power supply by wall socket and n. 05 cable stoppers in black for wall fixing.
- Hängelampe aus Massivholz in Ausführung SIBERIAN ASH, EUCALPTO ODER EICHE NATUR. Leuchtsystem mit LED COB 13W 1200LM 3000°K, nicht dimmbar. Inkl. Hängekabel bis zu 5mt, vorgesehen mit Stromversorgung durch Wand Steckdose und n. 05 schwarzen Kabelbinder für Wandbefestigung.
- Lampe à suspension en bois massif en finition SIBERIAN ASH, EUCALIPTO OU ROUVRE NATUREL. Système d'illumination avec LED COB 13W 1200LM 3000°K, non gradable. Inclus cable de suspension jusqu'à 5mt préparé pour alimentation avec prise de courant au mur e n. 05 serres-cable de couleur noir pour fixation au mur.

	I	dimensioni	spessore	volume	carico ammesso	peso	prezzo
	E	dimension	thickness	volume	admitted load	weight	price
	D	abmessungen	stärke	volumen	tragfähigkeit	gewicht	preis
	F	dimension	épaisseur	volume	charge admise	poids	prix
		cm	mm	m3	kg	kg	euro

Rook		Ø 25 x h 40		0,05		4	780
design Karim Rashid 2025							

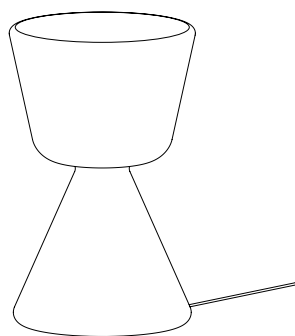

Optional set lampadine da n. 01 lampadina GU10 LED 50W e n. 03 lampadine G9 LED 25W	90
Optional set of bulbs with n. 01 GU10 LED 50W bulb and n. 03 G9 LED 25W bulbs	
Optionaler Birnenset mit n. 01 Birne GU10 LED 50W und n. 03 Birnen G9 LED 25W	
Optionnel set d'ampoules de n.01 ampoule GU10 LED 50W e n. 03 ampoules G9 LED 25W	

specificare il paese di destinazione
specify country of destination
immer Zielland angeben
toujours indiquer pays de destination

**Specificare sempre la finitura del vetro Ambra scuro, Bronzo, Fumè o Verde Pavone.
Always specify finish of glass in dark amber, bronze, smoked or peafowl green.
Immer Glasausführung angeben dunkles Amber, bronze, rauchfarbe oder Pfauengrün.
Toujours spécifier finition du verre ambre foncé, bronze, fumé ou vert paon.**

- Lampada da tavolo a luce LED dimmerabile, in vetro soffiato di Murano e parte inferiore sabbiata. Disponibile in diversi colori. Lampadine non incluse. Set lampadine optional.
Ogni pezzo viene soffiato, secondo la tradizionale tecnica, da artigiani del vetro di Murano. Eventuali imperfezioni dovute alla soffiatura del vetro sono da ritenersi caratteristiche del prodotto e dettagli di qualità e originalità.
- Table lamp with dimmable LED lighting, in Murano blown glass and lower part sanded. Available in different colours. Bulbs not included. Set of bulbs optional.
Each piece is blown, according to the traditional technique, by Murano glass artisans. Any imperfections due to glass blowing are to be considered characteristics of the product and details of quality and originality.
- Tischlampe mit LED-Beleuchtung dimmbar aus geblasenem Murano Glas und unteres Teil sandgestrahlt. In verschiedenen Farben erhältlich. Birnen nicht inklusiv. Birnenset optional.
Jedes Stück wird von Murano-Glashandwerkern nach traditioneller Technik geblasen. Eventuelle Unvollkommenheiten, die durch die Glasbläserei entstehen, sind als Eigenschaften des Produktes und als Angaben zur Qualität und Originalität anzusehen.
- Lamp de table avec lumière LED gradable, en verre soufflé de Murano et partie inférieure sablée. Disponible en différents couleurs. Ampoules pas incluses. Set ampoules optionnel.
Chaque pièce est soufflée, selon la technique traditionnelle, par des artisans verriers de Murano. Les éventuelles imperfections dues au soufflage du verre doivent être considérées comme des caractéristiques du produit et des détails de qualité et d'originalité.

	I	dimensioni	spessore	volume	carico ammesso	peso	prezzo
	E	dimension	thickness	volume	admitted load	weight	price
	D	abmessungen	stärke	volumen	tragfähigkeit	gewicht	preis
	F	dimension	épaisseur	volume	charge admise	poids	prix
		cm	mm	m3	kg	kg	euro

Transition design Paolo Benevelli 2026	L 80		0,02		6	1.470
	L 120		0,03		8	1.680
	L 160		0,04		10	1.960

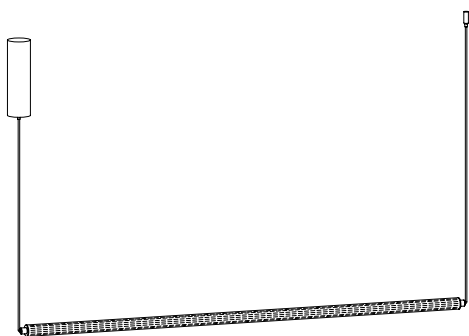

specificare il paese di destinazione
specify country of destination
immer Zielland angeben
toujours indiquer pays de destination

specificare sempre la finitura delle parti in metallo
always specify metal parts finish
immer Ausführung der Metallteile angeben
toujours spécifier finition des parts en metal

- Lampade a sospensione a luce LED COB dimmerabile 3000K 550/800/1100 lm / Lumen, in vetro pyrex rigato. Rosone e terminali in metallo nelle finiture Champagne e Titanio. Cavi di sospensione in pvc trasparente, regolabili in altezza fino a tre metri. Trasformatore già predisposto per impianti di domotica DALI.
- Pendant lamps with dimmable COB LED light 3000K 550/800/1100 lm / Lumen, in ribbed Pyrex glass. Metal ceiling rose and terminals in Champagne and Titanio finishes. Transparent PVC suspension cables, adjustable in height up to three meters. Driver already set up for DALI home automation systems.
- Pendelleuchten mit dimmbarer COB-LED-Beleuchtung 3000 K, 550/800/1100 lm / Lumen, aus geriffeltem Pyrexglas. Deckenrosette und Anschlüsse aus Metall in Champagne und Titanio Ausführung. Transparente PVC-Aufhängung, höhenverstellbar bis zu drei Meter. Transformator für DALI-Hausautomationsysteme vorgesehen.
- Suspensions avec éclairage LED COB dimmable 3000 K, 550/800/1100 lm / Lumen, en verre Pyrex côtelé. Rosace et bornes de plafond en métal finition Champagne et Titanio. Câbles de suspension en PVC transparent, réglables en hauteur jusqu'à trois mètres. Driver préconfiguré pour les systèmes domotiques DALI.

madie | cabinet | sideboards | cabinets

	I	dimensioni	spessore	volume	carico ammesso	peso	prezzo
	E	dimension	thickness	volume	admitted load	weight	price
	D	abmessungen	stärke	volumen	tragfähigkeit	gewicht	preis
	F	dimension	épaisseur	volume	charge admise	poids	prix
		cm	mm	m3	kg	kg	euro

Alicante 180 design Giovanna Azzarello 2026	181 x 50 x h 70		103	80 + 15 *	110	▲ 3.980 □ 4.250 ■ 4.310 ● 4.370
	181 x 50 x h 78		1,14	80 + 15 *	111	▲ 4.060 □ 4.330 ■ 4.390 ● 4.450

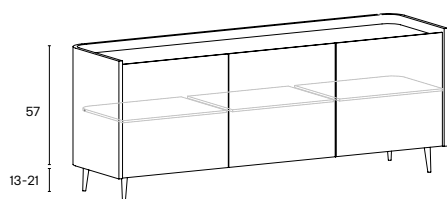

- ▲ Ante in legno laccate / lacquered wooden doors
lackierte Holztüren / portes en bois laqué
 - Ante in vetro extrachiaro / extra clear glass doors
extrahelle Glastüren / portes en verre extra clair
 - Ante in vetro fumé o bronzo / smoked or bronze glass doors
Rauch-oder Bronze Glastüren / portes en verre fumé ou bronze
 - Ante in vetro STOPSOL fumé o bronzo / smoked or bronze STOPSOL glass doors
Rauch-oder Bronze STOPSOL Glastüren / portes en verre STOPSOL fumé ou bronze
- * ogni ripiano / on each shelf / auf jedem Bord / pour chaque étagère

Maggiorazione per finitura laccato RAL opaco su struttura e ante in legno laccate
Surcharge for matt RAL lacquered finish on structure and lacquered wooden doors
Aufpreis für matte RAL Lackierung der Struktur und der lackierten Holztüren
Supplément pour finition laquée mate RAL sur la structure et les portes en bois laqué + 10%

Specificare sempre la finitura laccata della struttura e la finitura delle ante / always specify finish of lacquered structure and doors
immer Ausführung der lackierten Struktur und der Türen angeben / spécifier toujours finition laquée de la structure et la finition des portes.

Maggiorazione per finitura riporto top in ceramica / upcharge for top in ceramic / Aufpreis für Top in Keramik / surcharge pour top en céramique 390

Pietra di Savoia antracite bocciardato, Noir desir lucido o opaco, Calacatta oro venato lucido, Pietra Grey opaco, Sahara noir lucido o bocciardato, Travertino bocciardato.
Pietra di Savoia anthracite bocciardato, Noir desir polished or matt, Calacatta oro venato polished, Pietra Grey matt, Sahara noir polished or bocciardato, Travertino bocciardato.
Pietra di Savoia Anthrazit bocciardato, Noir desir glänzend oder matt, Calacatta oro venato glänzend, Pietra Grey matt, Sahara noir glänzend oder bocciardato, Travertino bocciardato.
Pietra di Savoia anthracite mat, Noir desir brillant ou mat, Calacatta oro venato brillant, Pietra Grey mat, Sahar noir brillant ou bocciardato, Travertino bocciardato.

Maggiorazione per finitura riporto top in marmo SPAZZOLATO OPACO / upcharge for top in brushed MATT MARBLE
Aufpreis für Top in MATT GEBÜRSTETEM MARMOR /surcharge pour top en MARBRE BROSSE MATT

top marmo Nero Marquinia / marble top Nero Marquinia /Marmortop Nero Marquinia / top marbre Nero Marquinia	1.540
top marmo Bianco Carrara / marble top Bianco Carrara/Marmortop Bianco Carrara / top marbre Bianco Carrara	1.600
top marmo Arabescato Orobico Gold / marble top Arabescato Orobico Gold/Marmortop Arabescato Orobico Gold / top marbre Arabescato Orobico Gold	1.750
top marmo Sahara Noir / marble top Sahara Noir/Marmortop Sahara Noir / top Sahara Noir	1.830
top marmo Tropikal Storm / marble top Tropikal Storm/Marmortop Tropikal Storm / top marbre Tropikal Storm/	1.980
top marmo Domus White / marble top Domus White/Marmortop Domus White / top marbre Domus White	2.270
top marmo Travertino Romano / marble top Travertino Romano / Marmortop Travertino Romano / top marbre Travertino Romano	1.870

Optional kit illuminazione interna luce LED 3000K dimmerabile con telecomando 680
Optional internal LED 3000K lighting dimmable with remote control
Optionales Innenbeleuchtungsset: dimmbare 3000K-LED-Leuchte mit Fernbedienung
Kit d'éclairage intérieur optionnel : éclairage LED à intensité variable 3000K avec télécommande

- Madia con struttura laccata opaco, internamente ed esternamente, **Champagne, Titanio, Dark Brown, Platino o Ral**, provvista di un ripiano vetro per vano, posizionabile in tre altezze. Ante battenti con chiusura soft close disponibili in legno **laccato opaco** nelle stesse finiture della struttura oppure in **vetro extrachiaro, fumé e bronzo o vetro Stopsol fumé e bronzo**. Piedi in metallo laccati come struttura, disponibili in due altezze. Optional kit illuminazione interna.
- Sideboard with matt lacquered structure, internally and externally, **Champagne, Titanium, Dark Brown, Platino or Ral**, equipped with one glass shelf per compartment, positionable at three heights. Hinged doors with soft-close mechanism, available in **matt lacquered wood** in the same finishes as the structure, or in **extra clear, smoked and bronze glass, or smoked and bronze Stopsol glass**. Metal legs lacquered to match the structure, available in two heights. Optional internal lighting.
- Sideboard mit matt lackierter Struktur, innen und außen, in **Champagne, Titanio, Dark Brown, Platino oder RAL**. Jedes Fach verfügt über einen Glasboden, der in drei Höhen verstellbar ist. Die Scharniertüren mit Soft-Close-Mechanismus sind in **matt lackiertem Holz** in den gleichen Farben wie die Struktur oder in **extrahellem, Rauch-oder Bronze Glas oder in Rauch-oder Bronze Stopsol Glas erhältlich**. Die Metallbeine sind farblich auf den Rahmen abgestimmt und in zwei Höhen verfügbar. Optional ist eine Innenbeleuchtung erhältlich.
- Buffet avec structure laquée mat, intérieur et extérieur, disponible en **Champagne, Titanio, Dark Brown, Platino ou RAL**, doté d'une étagère en verre par compartiment, réglable sur trois hauteurs. Portes à charnières avec système de fermeture amortie, disponibles en bois **laqué mat** assorti à la structure, ou en **verre extra clair, fumé et bronze, ou encore en verre Stopsol fumé et bronze**. Pieds en métal laqué assortis à la structure, disponibles en deux hauteurs. Kit d'éclairage intérieur en option.

	I	dimensioni	spessore	volume	carico ammesso	peso	prezzo
	E	dimension	thickness	volume	admitted load	weight	price
	D	abmessungen	stärke	volumen	tragfähigkeit	gewicht	preis
	F	dimension	épaisseur	volume	charge admise	poids	prix
		cm	mm	m3	kg	kg	euro

Alicante 240 design Giovanna Azzarello 2026	240 x 50 x h 70		1,37	80 + 15 *	145	▲ 4.980 □ 5.380 ■ 5.420 ● 5.500
	240 x 50 x h 78		1,52	80 + 15 *	146	▲ 5.060 □ 5.460 ■ 5.500 ● 5.580

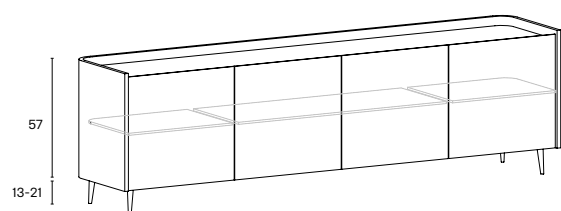

- ▲ Ante in legno laccate / lacquered wooden doors
lackierte Holztüren / portes en bois laqué
 - Ante in vetro extrachiaro / extra clear glass doors
extrahelle Glastüren / portes en verre extra clair
 - Ante in vetro fumé o bronzo / smoked or bronze glass doors
Rauch-oder Bronze Glastüren / portes en verre fumé ou bronze
 - Ante in vetro STOPSOL fumé o bronzo / smoked or bronze STOPSOL glass doors
Rauch-oder Bronze STOPSOL Glastüren / portes en verre STOPSOL fumé ou bronze
- * ogni ripiano / on each shelf / auf jedem Bord / pour chaque étagère

Maggiorazione per finitura laccato RAL opaco su struttura e ante in legno laccate
Surcharge for matt RAL lacquered finish on structure and lacquered wooden doors
Aufpreis für matte RAL Lackierung der Struktur und der lackierten Holztüren
Supplément pour finition laquée mate RAL sur la structure et les portes en bois laqué + 10%

Specificare sempre la finitura laccata della struttura e la finitura delle ante / always specify finish of lacquered structure and doors
immer Ausführung der lackierten Struktur und der Türen angeben / spécifier toujours finition laquée de la structure et la finition des portes.

Maggiorazione per finitura riporto top in ceramica / upcharge for top in ceramic / Aufpreis für Top in Keramik / surcharge pour top en céramique 450

Pietra di Savoia antracite bocciardato, Noir desir lucido o opaco, Calacatta oro venato lucido, Pietra Grey opaco, Sahara noir lucido o bocciardato, Travertino bocciardato.
Pietra di Savoia anthracite bocciardato, Noir desir polished or matt, Calacatta oro venato polished, Pietra Grey matt, Sahara noir polished or bocciardato, Travertino bocciardato.
Pietra di Savoia Anthrazit bocciardato, Noir desir glänzend oder matt, Calacatta oro venato glänzend, Pietra Grey matt, Sahara noir glänzend oder bocciardato, Travertino bocciardato.
Pietra di Savoia anthracite mat, Noir desir brillant ou mat, Calacatta oro venato brillant, Pietra Grey mat, Sahar noir brillant ou bocciardato, Travertino bocciardato.

Maggiorazione per finitura riporto top in marmo SPAZZOLATO OPACO / upcharge for top in brushed MATT MARBLE
Aufpreis für Top in MATT GEBÜRSTETEM MARMOR /surcharge pour top en MARBRE BROSSE MATT

top marmo Nero Marquina / marble top Nero Marquina /Marmortop Nero Marquina / top marbre Nero Marquina	2.170
top marmo Bianco Carrara / marble top Bianco Carrara/Marmortop Bianco Carrara / top marbre Bianco Carrara	2.240
top marmo Arabescato Orobico Gold / marble top Arabescato Orobico Gold/Marmortop Arabescato Orobico Gold / top marbre Arabescato Orobico Gold	2.450
top marmo Sahara Noir / marble top Sahara Noir/Marmortop Sahara Noir / top Sahara Noir	2.540
top marmo Tropikal Storm / marble top Tropikal Storm/Marmortop Tropikal Storm / top marbre Tropikal Storm/	2.750
top marmo Domus White / marble top Domus White/Marmortop Domus White / top marbre Domus White	3.120
top marmo Travertino Romano / marble top Travertino Romano / Marmortop Travertino Romano / top marbre Travertino Romano	2.630

Optional kit illuminazione interna luce LED 3000K dimmerabile con telecomando 710
Optional internal LED 3000K lighting dimmable with remote control
Optionales Innenbeleuchtungsset dimmbare 3000K-LED-Leuchte mit Fernbedienung
Optionnel Kit d'illumination intérieur LED 3000K à intensité variable avec télécommande

- Madia con struttura laccata opaco, internamente ed esternamente, **Champagne, Titanio, Dark Brown, Platino o Ral**, provvista di un ripiano vetro per vano, posizionabile in tre altezze. Ante battenti con chiusura soft close disponibili in legno **laccato opaco** nelle stesse finiture della struttura oppure in **vetro extrachiaro, fumé e bronzo o vetro Stopsol fumé e bronzo**. Piedi in metallo laccati come struttura, disponibili in due altezze. Optional kit illuminazione interna.
- Sideboard with matt lacquered structure, internally and externally, **Champagne, Titanium, Dark Brown, Platino or Ral**, equipped with one glass shelf per compartment, positionable at three heights. Hinged doors with soft-close mechanism, available in matt **lacquered wood** in the same finishes as the structure, or in **extra clear, smoked and bronze glass, or smoked and bronze Stopsol glass**. Metal legs lacquered to match the structure, available in two heights. Optional internal lighting.
- Sideboard mit matt lackierter Struktur, innen und außen, in **Champagne, Titanio, Dark Brown, Platino oder RAL**. Jedes Fach verfügt über einen Glasboden, der in drei Höhen verstellbar ist. Die Scharniertüren mit Soft-Close-Mechanismus sind in **matt lackiertem Holz** in den gleichen Farben wie die Struktur oder in **extrahellem, Rauch-oder Bronze Glas oder in Rauch-oder Bronze Stopsol Glas erhältlich**. Die Metallbeine sind farblich auf den Rahmen abgestimmt und in zwei Höhen verfügbar. Optional ist eine Innenbeleuchtung erhältlich.
- Buffet avec structure laquée mat, intérieur et extérieur, disponible en **Champagne, Titanio, Dark Brown, Platino ou RAL**, doté d'une étagère en verre par compartiment, réglable sur trois hauteurs. Portes à charnières avec système de fermeture amortie, disponibles en bois **laqué mat** assorti à la structure, ou en **verre extra clair, fumé et bronze, ou encore en verre Stopsol fumé et bronze**. Pieds en métal laqué assortis à la structure, disponibles en deux hauteurs. Kit d'éclairage intérieur en option.

	I E D F	dimensioni dimension abmessungen dimension	spessore thickness stärke épaisseur	volume volume volumen volume	carico ammesso admitted load tragfähigkeit charge admise	peso weight gewicht poids	prezzo price preis prix
		cm	mm	m3	kg	kg	euro

Aterea_180	A1	180 x 49 x h 69		1,20	80 + 15 *	198	
	A2	180 x 49 x h 83		1,28	80 + 15 *	204	

Tonelli design studio 2024

A1

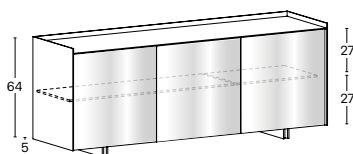

* ogni ripiano / on each shelf / auf jedem Bord / pour chaque étagère

	RIVESTIMENTI ESTERNI / EXTERNAL COVERINGS / AUSSEN BESCHICHTUNG / REVÊTEMENTS EXTÉRIEURS	
ANTE / DOORS / TÜRE / PORTES	vetro extrachiaro laccato champagne Titanio Dark Brown extra clear glass lacquered champagne Titanio Dark Brown extrahelles Glas lackiert Champagner Titanio Dark Brown verre extra clair verni champagne Titanio Dark Brown	vetro extrachiaro satinato laccato champagne Titanio Dark Brown extra clear frosted glass lacquered champagne Titanio Dark Brown extrahell geätztes Glas lackiert Champagner Titanio Dark Brown verre extra clair mordancé verni champagne Titanio Dark Brown
SPECCHIO liscio / flat MIRROR Glatter SPIEGEL / MIROIR lisse	4.280	4.510
T-BANDS laccato champagne Titanio Dark Brown T-BANDS lacquered champagne Titanio Dark Brown T-BANDS lackiert Champagner Titanio Dark Brown T-BANDS verni champagne Titanio Dark Brown	4.690	4.920
T-STRIPES specchio / T-STRIPES mirror T-STRIPES Spiegel / T-STRIPES miroir	4.780	5.010
T-BANDS specchio / T-BANDS mirror T-BANDS Spiegel / T-BANDS miroir	4.840	5.070

Specificare sempre la finitura dei rivestimenti esterni e la tipologia e finitura delle ante/ always specify finish of external coverings and type and finish of doors
 immer Ausführung der Außenbeschichtung angeben und Art und Ausführung der Türe/ spécifier toujours finitions des revêtements extérieurs et le type et finition des portes
 Specificare sempre la finitura dei piedi in vetro extrachiaro, fumè o bronzo/ always specify finish of feet in extra clear, smoked or bronze glass
 immer Ausführe der FüÙe in Glas angeben extrahell, Rauchglas oder Bronze/ toujours spécifier la finition des pieds en verre extra clair, fumè ou bronze

A2

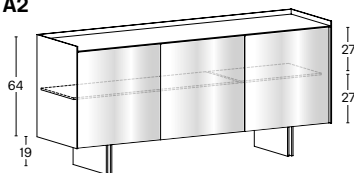

Maggiorazione per finitura laccato RAL opaco su struttura e ante T-Bands
Surcharge for matt RAL lacquered finish on structure and doors T-Bands
Aufpreis für matte RAL Lackierung von Struktur und Türen T-Bands
Supplément pour finition laquée mate RAL sur la structure et les portes T-Bands

+ 10%

	RIVESTIMENTI ESTERNI / EXTERNAL COVERINGS / AUSSEN BESCHICHTUNG / REVÊTEMENTS EXTÉRIEURS	
ANTE / DOORS / TÜRE / PORTES	vetro extrachiaro laccato champagne Titanio Dark Brown extra clear glass lacquered champagne Titanio Dark Brown extrahelles Glas lackiert Champagner Titanio Dark Brown verre extra clair verni champagne Titanio Dark Brown	vetro extrachiaro satinato laccato champagne Titanio Dark Brown extra clear frosted glass lacquered champagne Titanio Dark Brown extrahell geätztes Glas lackiert Champagner Titanio Dark Brown verre extra clair mordancé verni champagne Titanio Dark Brown
SPECCHIO liscio / flat MIRROR Glatter SPIEGEL / MIROIR lisse	4.450	4.680
T-BANDS laccato champagne Titanio Dark Brown T-BANDS lacquered champagne Titanio Dark Brown T-BANDS lackiert Champagner Titanio Dark Brown T-BANDS verni champagne Titanio Dark Brown	4.860	5.090
T-STRIPES specchio / T-STRIPES mirror T-STRIPES Spiegel / T-STRIPES miroir	4.950	5.180
T-BANDS specchio / T-BANDS mirror T-BANDS Spiegel / T-BANDS miroir	5.010	5.240

Specificare sempre la finitura dei rivestimenti esterni e la tipologia e finitura delle ante/ always specify finish of external coverings and type and finish of doors
 immer Ausführung der Außenbeschichtung angeben und Art und Ausführung der Türe/ spécifier toujours finitions des revêtements extérieurs et le type et finition des portes
 Specificare sempre la finitura dei piedi in vetro extrachiaro, fumè o bronzo/ always specify finish of feet in extra clear, smoked or bronze glass
 immer Ausführe der FüÙe in Glas angeben extrahell, Rauchglas oder Bronze/ toujours spécifier la finition des pieds en verre extra clair, fumè ou bronze

	I	dimensioni	spessore	volume	carico ammesso	peso	prezzo
	E	dimension	thickness	volume	admitted load	weight	price
	D	abmessungen	stärke	volumen	tragfähigkeit	gewicht	preis
	F	dimension	épaisseur	volume	charge admise	poids	prix
		cm	mm	m3	kg	kg	euro

Aterea_180 Optionals

Tonelli design studio 2024

Maggiorazione per finitura riporto top in ceramica / upcharge for top in ceramic / Aufpreis für Top in Keramik / surcharge pour top en céramique

470

Pietra di Savoia antracite bocciardato, Noir desir lucido o opaco, Calacatta oro venato lucido, Pietra Grey opaco,
Sahara noir lucido o bocciardato, Travertino bocciardato.
Pietra di Savoia anthracite polished or matt, Calacatta oro venato polished, Pietra Grey matt,
Sahara noir polished or bocciardato, Travertino bocciardato.
Pietra di Savoia Anthrazit bocciardato, Noir desir glänzend oder matt, Calacatta oro venato glänzend, Pietra Grey matt,
Sahara noir glänzend oder bocciardato, Travertino bocciardato.
Pietra di Savoia anthracite mat, Noir desir brillant ou mat, Calacatta oro venato brillant, Pietra Grey mat,
Sahar noir brillant ou bocciardato, Travertino bocciardato.

Maggiorazione per finitura riporto top in marmo SPAZZOLATO OPACO / upcharge for top in brushed MATT MARBLE Aufpreis für Top in MATT GEBÜRSTETEM MARMOR /surcharge pour top en MARBRE BROSSE MATT

top marmo Nero Marquinia / marble top Nero Marquinia /Marmortop Nero Marquinia / top marbre Nero Marquinia	1.540
top marmo Bianco Carrara / marble top Bianco Carrara/Marmortop Bianco Carrara / top marbre Bianco Carrara	1.600
top marmo Arabescato Orobico Gold / marble top Arabescato Orobico Gold/Marmortop Arabescato Orobico Gold / top marbre Arabescato Orobico Gold	1.750
top marmo Sahara Noir / marble top Sahara Noir/Marmortop Sahara Noir / top Sahara Noir	1.830
top marmo Tropikal Storm / marble top Tropikal Storm/Marmortop Tropikal Storm / top marbre Tropikal Storm/	1.980
top marmo Domus White / marble top Domus White/Marmortop Domus White / top marbre Domus White	2.270
top marmo Travertino Romano / marble top Travertino Romano / Marmortop Travertino Romano / top marbre Travertino Romano	1.870

Optional kit illuminazione a LED (con telecomando) inserito sotto la base / Optional LED lighting kit (with remote control) placed under the base Optionale LED Beleuchtung (mit Fernbedienung) unter dem Gestell /optionnelle kit d'illumination LED (avec télécommande) inseré sous la base

680

- Madia con struttura interna in legno e un ripiano in vetro extrachiaro per vano posizionabile in tre altezze.
Rivestimenti esterni in vetro extrachiaro (effetto lucido) o extrachiaro satinato (effetto opaco), retrolaccato champagne, Titanio o Dark Brown.
Optional riporto top in ceramica o marmo.
Ante battenti rivestite a:
Specchio liscio finiture specchio **standard, fumè o bronzo** oppure in vetro nelle varianti:
Vetro T-Bands specchio standard, fumè o bronzo.
Vetro T-Stripes specchio fume o bronzo.
Vetro T-Bands retrolaccato champagne, Titanio, Dark Brown o RAL.
Piedi in vetro saldato extrachiaro, fumè o bronzo. Optional kit illuminazione LED sotto la base, con telecomando.
- Sideboard with internal structure in wood and an internal extra clear glass shelf for each compartment that can be placed on 3 different heights.
External coverings in extra clear glass (polished effect) or extra clear frosted glass (matt effect), backlacquered champagne, Titanio or Dark Brown.
Optional countertop in ceramic or marble.
Flap doors with coverings in:
Flat mirror finish **standard, smoked or bronze** or with glass in following variations:
Glass T-Bands standard, smoked or bronze mirror.
Glass T-Stripes smoked or bronze mirror.
Glass T-Bands backlacquered champagne, Titanio, Dark Brown or RAL.
Feet in welded glass extra clear, smoked or bronze. Optional LED lighting kit under the base with remote control.
- Sideboard mit Innenstruktur aus Holz und inneres Fach pro Stauraum aus extrahellem Glas das auf drei verschiedenen Höhen angebracht werden kann.
Außenverkleidungen aus extrahellem Glas (glänzender Effekt) oder extrahell geätzt (matt Effekt), hinter lackiert Champagner, Titanio oder Dark Brown.
Optionaler Top aus Keramik oder Marmor.
Flügeltüre beschichtet mit:
Glatter Spiegel Ausführung **standard, Rauchfarbe oder Bronze.**
Glass T-Bands standard, Rauchfarbe oder Bronze Spiegel.
Glass T-Stripes Rauchfarbe oder Bronze Spiegel.
Glass T-Bands hinter lackiert Champagner, Titanio, Dark Brown oder RAL.
Füße aus geschweißtem Glas extrahell, Rauchfarbe oder Bronze. Optionale LED-Beleuchtung unter dem Gestell mit Fernbedienung.
- Sideboard avec structure intérieur en bois et étagère intérieur chaque compartiment en verre extra clair positionnables en trois hauteurs.
Revêtements externes en verre extra clair (effet brillant) ou extra clair mordancé (effet mat), retroverni champagne, Titanio ou Dark Brown.
Optionnel top en céramique ou marbre.
Portes battantes recouvertes en:
Miroir lisse en finition **standard, fumé ou bronze,** ou en verre dans les finitions suivants:
Verre T-Bands miroir standard, fumé ou bronze.
Verre T-Stripes miroir fumé ou bronze.
Verre T-Bands retroverni champagne, Titanio, Dark Brown ou RAL.
Pieds en verre soudé extra clair, fumé ou bronze. Optionnelle kit d'illumination LED sous la base avec télécommande.

	I E D F	dimensioni dimension abmessungen dimension	spessore thickness stärke épaisseur	volume volume volumen volume	carico ammesso admitted load tragfähigkeit charge admise	peso weight gewicht poids	prezzo price preis prix
		cm	mm	m3	kg	kg	euro

Aterea_240	A3	240 x 49 x h 69		1,50	80 + 15 *	255	
	A4	240 x 49 x h 83		1,58	80 + 15 *	261	

Tonelli design studio 2024

A3

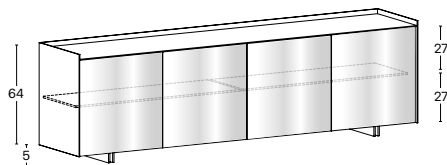

* ogni ripiano / on each shelf / auf jedem Bord / pour chaque étagère

	RIVESTIMENTI ESTERNI / EXTERNAL COVERINGS / AUSSEN BESCHICHTUNG / REVÊTEMENTS EXTÉRIEURS	
ANTE / DOORS / TÜRE / PORTES	vetro extrachiaro laccato champagne Titanio Dark Brown extra clear glass lacquered champagne Titanio Dark Brown extrahelles Glas lackiert Champagner Titanio Dark Brown verre extra clair verni champagne Titanio Dark Brown	vetro extrachiaro satinato laccato champagne Titanio Dark Brown extra clear frosted glass lacquered champagne Titanio Dark Brown extrahell geätzt Glas lackiert Champagner Titanio Dark Brown verre extra clair mordancé verni champagne Titanio Dark Brown
SPECCHIO liscio / flat MIRROR Glatter SPIEGEL / MIROIR lisse	4.870	5.200
T-BANDS laccato champagne Titanio Dark Brown T-BANDS lacquered champagne Titanio Dark Brown T-BANDS lackiert Champagner Titanio Dark Brown T-BANDS verni champagne Titanio Dark Brown	5.410	5.740
T-STRIPES specchio / T-STRIPES mirror T-STRIPES Spiegel / T-STRIPES miroir	5.530	5.860
T-BANDS specchio / T-BANDS mirror T-BANDS Spiegel / T-BANDS miroir	5.610	5.940

Specificare sempre la finitura dei rivestimenti esterni e la tipologia e finitura delle ante/ always specify finish of external coverings and type and finish of doors
immer Ausführung der Außenbeschichtung angeben und Art und Ausführung der Türe/ spécifier toujours finitions des revêtements extérieurs et le type et finition des portes
Specificare sempre la finitura dei piedi in vetro extrachiaro, fumè o bronzo/ always specify finish of feet in extra clear, smoked or bronze glass
immer Ausführe der FüÙe in Glas angeben extrahell, Rauchglas oder Bronze/ toujours spécifier la finition des pieds en verre extra clair, fumè ou bronze

A4

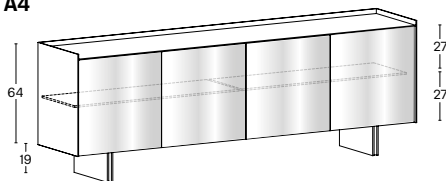

Maggiorazione per finitura laccato RAL opaco su struttura e ante T-Bands
Surcharge for matt RAL lacquered finish on structure and doors T-Bands
Aufpreis für matte RAL Lackierung von Struktur und Türen T-Bands
Supplément pour finition laquée mate RAL sur la structure et les portes T-Bands

+ 10%

	RIVESTIMENTI ESTERNI / EXTERNAL COVERINGS / AUSSEN BESCHICHTUNG / REVÊTEMENTS EXTÉRIEURS	
ANTE / DOORS / TÜRE / PORTES	vetro extrachiaro laccato champagne Titanio Dark Brown extra clear glass lacquered champagne Titanio Dark Brown extrahelles Glas lackiert Champagner Titanio Dark Brown verre extra clair verni champagne Titanio Dark Brown	vetro extrachiaro satinato laccato champagne Titanio Dark Brown extra clear frosted glass lacquered champagne Titanio Dark Brown extrahell geätzt Glas lackiert Champagner Titanio Dark Brown verre extra clair mordancé verni champagne Titanio Dark Brown
SPECCHIO liscio / flat MIRROR Glatter SPIEGEL / MIROIR lisse	5.040	5.370
T-BANDS laccato champagne Titanio Dark Brown T-BANDS lacquered champagne Titanio Dark Brown T-BANDS lackiert Champagner Titanio Dark Brown T-BANDS verni champagne Titanio Dark Brown	5.580	5.910
T-STRIPES specchio / T-STRIPES mirror T-STRIPES Spiegel / T-STRIPES miroir	5.700	6.030
T-BANDS specchio / T-BANDS mirror T-BANDS Spiegel / T-BANDS miroir	5.780	6.110

Specificare sempre la finitura dei rivestimenti esterni e la tipologia e finitura delle ante/ always specify finish of external coverings and type and finish of doors
immer Ausführung der Außenbeschichtung angeben und Art und Ausführung der Türe/ spécifier toujours finitions des revêtements extérieurs et le type et finition des portes
Specificare sempre la finitura dei piedi in vetro extrachiaro, fumè o bronzo/ always specify finish of feet in extra clear, smoked or bronze glass
immer Ausführe der FüÙe in Glas angeben extrahell, Rauchglas oder Bronze/ toujours spécifier la finition des pieds en verre extra clair, fumè ou bronze

	I	dimensioni	spessore	volume	carico ammesso	peso	prezzo
	E	dimension	thickness	volume	admitted load	weight	price
	D	abmessungen	stärke	volumen	tragfähigkeit	gewicht	preis
	F	dimension	épaisseur	volume	charge admise	poids	prix
		cm	mm	m3	kg	kg	euro

Aterea_240 Optionals

Tonelli design studio 2024

Maggiorazione per finitura riporto top in ceramica / upcharge for top in ceramic / Aufpreis für Top in Keramik / surcharge pour top en céramique **630**

Pietra di Savoia antracite bocciardato, Noir desir lucido o opaco, Calacatta oro venato lucido, Pietra Grey opaco,
Sahara noir lucido o bocciardato, Travertino bocciardato.
Pietra di Savoia anthracite polished or matt, Calacatta oro venato polished, Pietra Grey matt,
Sahara noir polished or bocciardato, Travertino bocciardato.
Pietra di Savoia Anthrazit bocciardato, Noir desir glänzend oder matt, Calacatta oro venato glänzend, Pietra Grey matt,
Sahara noir glänzend oder bocciardato, Travertino bocciardato.
Pietra di Savoia anthracite mat, Noir desir brillant ou mat, Calacatta oro venato brillant, Pietra Grey mat,
Sahar noir brillant ou bocciardato, Travertino bocciardato.

Maggiorazione per finitura riporto top in marmo SPAZZOLATO OPACO / upcharge for top in brushed MATT MARBLE
Aufpreis für Top in MATT GEBÜRSTETEM MARMOR /surcharge pour top en MARBRE BROSSE MATT

top marmo Nero Marquinia / marble top Nero Marquinia /Marmortop Nero Marquinia / top marbre Nero Marquinia	2.170
top marmo Bianco Carrara / marble top Bianco Carrara/Marmortop Bianco Carrara / top marbre Bianco Carrara	2.240
top marmo Arabescato Orobico Gold / marble top Arabescato Orobico Gold/Marmortop Arabescato Orobico Gold / top marbre Arabescato Orobico Gold	2.450
top marmo Sahara Noir / marble top Sahara Noir/Marmortop Sahara Noir / top Sahara Noir	2.540
top marmo Tropikal Storm / marble top Tropikal Storm/Marmortop Tropikal Storm / top marbre Tropikal Storm/	2.750
top marmo Domus White / marble top Domus White/Marmortop Domus White / top marbre Domus White	3.120
top marmo Travertino Romano / marble top Travertino Romano / Marmortop Travertino Romano / top marbre Travertino Romano	2.630

Optional kit illuminazione a LED (con telecomando) inserito sotto la base / Optional LED lighting kit (with remote control) placed under the base **710**
Optionale LED Beleuchtung (mit Fernbedienung) unter dem Gestell /optionnelle kit d'illumination LED (avec télécommande) inseré sous la base

- Madia con struttura interna in legno e un ripiano in vetro extrachiaro per vano posizionabile in tre altezze.
Rivestimenti esterni in vetro extrachiaro (effetto lucido) o extrachiaro satinato (effetto opaco), retrolaccato champagne, Titanio o Dark Brown.
Optional riporto top in ceramica o marmo.
Ante battenti rivestite a:
Specchio liscio finiture specchio **standard, fumè o bronzo** oppure in vetro nelle varianti:
Vetro T-Bands specchio standard, fumè o bronzo.
Vetro T-Stripes specchio fume o bronzo.
Vetro T-Bands retrolaccato champagne, Titanio, Dark Brown o RAL.
Piedi in vetro saldato extrachiaro, fumè o bronzo. Optional kit illuminazione LED sotto la base, con telecomando.
- Sideboard with internal structure in wood and an internal extra clear glass shelf for each compartment that can be placed on 3 different heights.
External coverings in extra clear glass (polished effect) or extra clear frosted glass (matt effect), backlacquered champagne, Titanio or Dark Brown.
Optional countertop in ceramic or marble.
Flap doors with coverings in:
Flat mirror finish **standard, smoked or bronze** or with glass in following variations:
Glass T-Bands standard, smoked or bronze mirror.
Glass T-Stripes smoked or bronze mirror.
Glass T-Bands backlacquered champagne, Titanio, Dark Brown or RAL.
Feet in welded glass extra clear, smoked or bronze. Optional LED lighting kit under the base with remote control.
- Sideboard mit Innenstruktur aus Holz und inneres Fach pro Stauraum aus extrahellem Glas das auf drei verschiedenen Höhen angebracht werden kann.
Außenverkleidungen aus extrahellem Glas (glänzender Effekt) oder extrahell geätzt (matt Effekt), hinter lackiert Champagner, Titanio oder Dark Brown.
Optionaler Top aus Keramik oder Marmor.
Flügeltüre beschichtet mit:
Glatter Spiegel Ausführung **standard, Rauchfarbe oder Bronze.**
Glass T-Bands standard, Rauchfarbe oder Bronze Spiegel.
Glass T-Stripes Rauchfarbe oder Bronze Spiegel.
Glass T-Bands hinter lackiert Champagner, Titanio, Dark Brown oder RAL.
Füße aus geschweißtem Glas extrahell, Rauchfarbe oder Bronze. Optionale LED-Beleuchtung unter dem Gestell mit Fernbedienung.
- Sideboard avec structure intérieur en bois et étagère intérieur chaque compartiment en verre extra clair positionnables en trois hauteurs.
Revêtements externes en verre extra clair (effet brillant) ou extra clair mordancé (effet mat), retroverni champagne, Titanio ou Dark Brown.
Optionnel top en céramique ou marbre.
Portes battantes recouvertes en:
Miroir lisse en finition **standard, fumé ou bronze,** ou en verre dans les finitions suivants:
Verre T-Bands miroir standard, fumé ou bronze.
Verre T-Stripes miroir fumé ou bronze.
Verre T-Bands retroverni champagne, Titanio, Dark Brown ou RAL.
Pieds en verre soudé extra clair, fumé ou bronze. Optionnelle kit d'illumination LED sous la base avec télécommande.

	I E D F	dimensioni dimension abmessungen dimension	spessore thickness stärke épaisseur	volume volume volumen volume	carico ammesso admitted load tragfähigkeit charge admise	peso weight gewicht poids	prezzo price preis prix
		cm	mm	m3	kg	kg	euro

Aterea_240 VG

A5 240 x 49 x h 69

A6 240 x 49 x h 83

1,58

1,66

80 + 15 *

80 + 15 *

281

287

Tonelli design studio 2025

A5

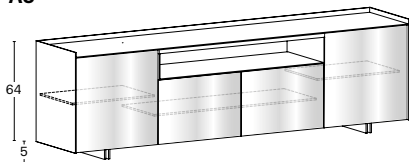

* ogni ripiano / on each shelf / auf jedem Bord / pour chaque étagère

	RIVESTIMENTI ESTERNI / EXTERNAL COVERINGS / AUSSEN BESCHICHTUNG / REVÊTEMENTS EXTÉRIEURS	
ANTE / DOORS / TÜRE / PORTES	vetro extrachiaro laccato champagne Titanio Dark Brown extra clear glass lacquered champagne Titanio Dark Brown extrahelles Glas lackiert Champagner Titanio Dark Brown verre extra clair verni champagne Titanio Dark Brown	vetro extrachiaro satinato laccato champagne Titanio Dark Brown extra clear frosted glass lacquered champagne Titanio Dark Brown extrahell geätztes Glas lackiert Champagner Titanio Dark Brown verre extra clair mordancé verni champagne Titanio Dark Brown
SPECCHIO liscio / flat MIRROR Glatter SPIEGEL / MIROIR lisse	5.030	5.360
T-BANDS laccato champagne Titanio Dark Brown T-BANDS lacquered champagne Titanio Dark Brown T-BANDS lackiert Champagner Titanio Dark Brown T-BANDS verni champagne Titanio Dark Brown	5.460	5.790
T-STRIPES specchio / T-STRIPES mirror T-STRIPES Spiegel / T-STRIPES miroir	5.780	6.110
T-BANDS specchio / T-BANDS mirror T-BANDS Spiegel / T-BANDS miroir	6.040	6.370

Specificare sempre la finitura dei rivestimenti esterni, la tipologia e finitura delle ante e la finitura del profilo in legno
always specify finish of external coverings, type and finish of doors and finish of wooden profile
immer angeben: Ausführung der Außenbeschichtung, Art und Ausführung der Türe und Ausführung der Holzprofile
spécifier toujours finitions des revêtements extérieurs, le type et finition des portes e finition du profil en bois

A6

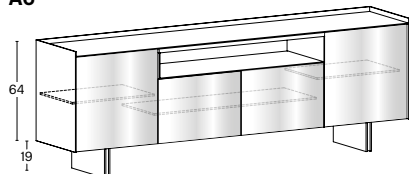

Maggiorazione per finitura laccato RAL opaco su struttura e ante T-Bands
Surcharge for matt RAL lacquered finish on structure and doors T-Bands
Aufpreis für matte RAL Lackierung von Struktur und Türen T-Bands
Supplément pour finition laquée mate RAL sur la structure et les portes T-Bands

+ 10%

	RIVESTIMENTI ESTERNI / EXTERNAL COVERINGS / AUSSEN BESCHICHTUNG / REVÊTEMENTS EXTÉRIEURS	
ANTE / DOORS / TÜRE / PORTES	vetro extrachiaro laccato champagne Titanio Dark Brown extra clear glass lacquered champagne Titanio Dark Brown extrahelles Glas lackiert Champagner Titanio Dark Brown verre extra clair verni champagne Titanio Dark Brown	vetro extrachiaro satinato laccato champagne Titanio Dark Brown extra clear frosted glass lacquered champagne Titanio Dark Brown extrahell geätztes Glas lackiert Champagner Titanio Dark Brown verre extra clair mordancé verni champagne Titanio Dark Brown
SPECCHIO liscio / flat MIRROR Glatter SPIEGEL / MIROIR lisse	5.200	5.530
T-BANDS laccato champagne Titanio Dark Brown T-BANDS lacquered champagne Titanio Dark Brown T-BANDS lackiert Champagner Titanio Dark Brown T-BANDS verni champagne Titanio Dark Brown	5.630	5.960
T-STRIPES specchio / T-STRIPES mirror T-STRIPES Spiegel / T-STRIPES miroir	5.950	6.280
T-BANDS specchio / T-BANDS mirror T-BANDS Spiegel / T-BANDS miroir	6.210	6.540

Specificare sempre la finitura dei rivestimenti esterni, la tipologia e finitura delle ante e la finitura del profilo in legno
always specify finish of external coverings, type and finish of doors and finish of wooden profile
immer angeben: Ausführung der Außenbeschichtung, Art und Ausführung der Türe und Ausführung der Holzprofile
spécifier toujours finitions des revêtements extérieurs, le type et finition des portes e finition du profil en bois

	I	dimensioni	spessore	volume	carico ammesso	peso	prezzo
	E	dimension	thickness	volume	admitted load	weight	price
	D	abmessungen	stärke	volumen	tragfähigkeit	gewicht	preis
	F	dimension	épaisseur	volume	charge admise	poids	prix
		cm	mm	m3	kg	kg	euro

Aterea_240 VG Optionals

Tonelli design studio 2025

Maggiorazione per finitura riporto top in ceramica / upcharge for top in ceramic / Aufpreis für Top in Keramik / surcharge pour top en céramique

630

Pietra di Savoia antracite bocciardato, Noir desir lucido o opaco, Calacatta oro venato lucido, Pietra Grey opaco, Sahara noir lucido o bocciardato, Travertino bocciardato.
 Pietra di Savoia anthracite bocciardato, Noir desir polished or matt, Calacatta oro venato polished, Pietra Grey matt, Sahara noir polished or bocciardato, Travertino bocciardato.
 Pietra di Savoia Anthrazit bocciardato, Noir desir glänzend oder matt, Calacatta oro venato glänzend, Pietra Grey matt, Sahara noir glänzend oder bocciardato, Travertino bocciardato.
 Pietra di Savoia anthracite mat, Noir desir brillant ou mat, Calacatta oro venato brillant, Pietra Grey mat, Sahar noir brillant ou bocciardato, Travertino bocciardato.

Maggiorazione per finitura riporto top in marmo SPAZZOLATO OPACO / upcharge for top in brushed MATT MARBLE Aufpreis für Top in MATT GEBÜRSTETEM MARMOR /surcharge pour top en MARBRE BROSSE MATT

top marmo Nero Marquinia / marble top Nero Marquinia /Marmortop Nero Marquinia / top marbre Nero Marquinia	2.170
top marmo Bianco Carrara / marble top Bianco Carrara/Marmortop Bianco Carrara / top marbre Bianco Carrara	2.240
top marmo Arabescato Orobico Gold / marble top Arabescato Orobico Gold/Marmortop Arabescato Orobico Gold / top marbre Arabescato Orobico Gold	2.450
top marmo Sahara Noir / marble top Sahara Noir/Marmortop Sahara Noir / top Sahara Noir	2.540
top marmo Tropikal Storm / marble top Tropikal Storm/Marmortop Tropikal Storm / top marbre Tropikal Storm/	2.750
top marmo Domus White / marble top Domus White/Marmortop Domus White / top marbre Domus White	3.120
top marmo Travertino Romano / marble top Travertino Romano / Marmortop Travertino Romano / top marbre Travertino Romano	2.630

Optional kit illuminazione a LED (con telecomando) inserito sotto la base / Optional LED lighting kit (with remote control) placed under the base Optionale LED Beleuchtung (mit Fernbedienung) unter dem Gestell /optionnelle kit d'illumination LED (avec télécommande) inseré sous la base

710

- Madia con vano a giorno rivestito in vetro con profilo in legno massello **SIBERIAN ASH, EUCALIPTO o NOCE CANALETTO**.
 Struttura interna in legno con un ripiano in vetro extrachiaro per vano posizionabile in diverse altezze.
 Rivestimenti esterni in vetro extrachiaro (effetto lucido) o extrachiaro satinato (effetto opaco), retrolaccato champagne, Titanio o Dark Brown.
 Optional riporto top in ceramica o marmo.
 Ante battenti rivestite a: **Specchio liscio** finiture specchio **standard, fumè o bronzo** oppure in vetro nelle varianti:
Vetro T-Bands specchio standard, fumè o bronzo,
Vetro T-Stripes specchio fumè o bronzo
Vetro T-Bands retrolaccato champagne, Titanio, Dark Brown o RAL.
 Piedi in vetro saldato extrachiaro, fumè o bronzo.
 Optional kit illuminazione LED sotto la base, con telecomando.
- Sideboard with open space covered in glass and profiles in solid wood in **SIBERIAN ASH, EUCALIPTO or WALNUT CANALETTO**.
 Internal structure in wood and an internal extra clear glass shelf for each compartment that can be placed on different heights.
 External coverings in extra clear glass (polished effect) or extra clear frosted glass (matt effect), backlacquered champagne, Titanio or Dark Brown.
 Außenverkleidungen aus extrahellem Glas (glänzender Effekt) oder extrahell geätzt (matt Effekt), hinter lackiert Champagner, Titanio oder Dark Brown.
 Optionaler Top aus Keramik oder Marmor.
 Flügeltüre beschichtet mit: **Glatter Spiegel** Ausführung **standard, Rauchfarbe oder Bronze**.
Glass T-Bands standard, Rauchfarbe oder Bronze Spiegel.
Glass T-Stripes Rauchfarbe oder Bronze Spiegel.
Glass T-Bands hinter lackiert Champagner, Titanio, Dark Brown oder RAL.
 Feet in welded glass extra clear, smoked or bronze. Optional LED lighting kit under the base with remote control.
- Sideboard mit offenem Fach mit Bekleidung aus Glas und Profile aus Massivholz in **SIBERIAN ASH, EUCALIPTO oder WALNUS CANALETTO**.
 Innenstruktur aus Holz und inneres Fach pro Stauraum aus extrahellem Glas das auf verschiedenen Höhen angebracht werden kann.
 Außenverkleidungen aus extrahellem Glas (glänzender Effekt) oder extrahell geätzt (matt Effekt), hinter lackiert Champagner, Titanio oder Dark Brown.
 Optionaler Top aus Keramik oder Marmor.
 Flügeltüre beschichtet mit: **Glatter Spiegel** Ausführung **standard, Rauchfarbe oder Bronze**.
Glass T-Bands standard, Rauchfarbe oder Bronze Spiegel.
Glass T-Stripes Rauchfarbe oder Bronze Spiegel.
Glass T-Bands hinter lackiert Champagner, Titanio, Dark Brown oder RAL.
 Füße aus geschweißtem Glas extrahell, Rauchfarbe oder Bronze. Optionale LED-Beleuchtung unter dem Gestell mit Fernbedienung.
- Sideboard avec section ouvert revêtu en verre et profils en bois massif en **SIBERIAN ASH, EUCALIPTO ou NOYER CANALETTO**.
 Structure intérieure en bois et étagère intérieur chaque compartiment en verre extra clair positionnables à différentes hauteurs.
 Revêtements externes en verre extra clair (effet brillant) ou extra clair mordancé (effet mat), retroverni champagne, Titanio ou Dark Brown. Optionnel top en céramique ou marbre.
 Portes battantes recouvertes en: **Miroir lisse** en finition **standard, fumé ou bronze**, ou en verre dans les finitions suivants:
Verre T-Bands miroir standard, fumé ou bronze.
Verre T-Stripes miroir fumé ou bronze.
Verre T-Bands retroverni champagne, Titanio, Dark Brown ou RAL.
 Pieds en verre soudé extra clair, fumé ou bronze. Optionnelle kit d'illumination LED sous la base avec télécommande.

	I E D F	dimensioni dimension abmessungen dimension	spessore thickness stärke épaisseur	volume volume volumen volume	carico ammesso admitted load tragfähigkeit charge admise	peso weight gewicht poids	prezzo price preis prix
		cm	mm	m3	kg	kg	euro

Aterea_Cabinet Tonelli design studio 2025	C1 120 x 49 x h 129		1,40	80 + 15 *	246	
	C2 120 x 49 x h 143		1,55	80 + 15 *	273	

C1

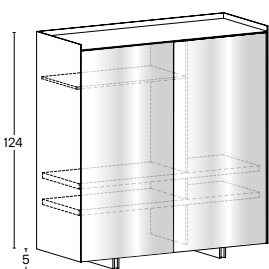

C2

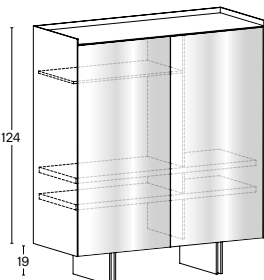

* ogni ripiano / on each shelf / auf jedem Bord / pour chaque étagère

Maggiorazione per finitura laccato RAL opaco su struttura e ante T-Bands
 Surcharge for matt RAL lacquered finish on structure and doors T-Bands
 Aufpreis für matte RAL Lackierung von Struktur und Türen T-Bands
 Supplément pour finition laquée mate RAL sur la structure et les portes T-Bands + 10%

C1	RIVESTIMENTI ESTERNI / EXTERNAL COVERINGS / AUSSEN BESCHICHTUNG / REVÊTEMENTS EXTÉRIEURS	
ANTE / DOORS / TÜRE / PORTES	vetro extrachiaro laccato champagne Titanio Dark Brown extra clear glass lacquered champagne Titanio Dark Brown extrahelles Glas lackiert Champagner Titanio Dark Brown verre extra clair verni champagne Titanio Dark Brown	vetro extrachiaro satinato laccato champagne Titanio Dark Brown extra clear frosted glass lacquered champagne Titanio Dark Brown extrahell geätztes Glas lackiert Champagner Titanio Dark Brown verre extra clair mordancé verni champagne Titanio Dark Brown
SPECCHIO liscio / flat MIRROR Glatter SPIEGEL / MIROIR lisse	7.690	8.190
T-BANDS laccato champagne Titanio Dark Brown T-BANDS lacquered champagne Titanio Dark Brown T-BANDS lackiert Champagner Titanio Dark Brown T-BANDS verni champagne Titanio Dark Brown	8.040	8.540
T-STRIPES specchio / T-STRIPES mirror T-STRIPES Spiegel / T-STRIPES miroir	8.590	9.090
T-BANDS specchio / T-BANDS mirror T-BANDS Spiegel / T-BANDS miroir	8.780	9.280

Specificare sempre la finitura dei rivestimenti esterni, la tipologia e finitura delle ante, la finitura dei ripiani in legno e dei divisori interni in vetro
 always specify finish of external coverings, type and finish of doors, finish of wooden shelf and internal glass dividers
 immer Ausführung der Außenbeschichtung angeben, sowie Art und Ausführung der Türe, Ausführung der Holzfücher und internen Glasabteilungen
 spécifier toujours finitions des revêtements extérieurs, le type et finition des portes, finition des étagères en bois et des cloisons en verre

C2	RIVESTIMENTI ESTERNI / EXTERNAL COVERINGS / AUSSEN BESCHICHTUNG / REVÊTEMENTS EXTÉRIEURS	
ANTE / DOORS / TÜRE / PORTES	vetro extrachiaro laccato champagne Titanio Dark Brown extra clear glass lacquered champagne Titanio Dark Brown extrahelles Glas lackiert Champagner Titanio Dark Brown verre extra clair verni champagne Titanio Dark Brown	vetro extrachiaro satinato laccato champagne Titanio Dark Brown extra clear frosted glass lacquered champagne Titanio Dark Brown extrahell geätztes Glas lackiert Champagner Titanio Dark Brown verre extra clair mordancé verni champagne Titanio Dark Brown
SPECCHIO liscio / flat MIRROR Glatter SPIEGEL / MIROIR lisse	7.840	8.340
T-BANDS laccato champagne Titanio Dark Brown T-BANDS lacquered champagne Titanio Dark Brown T-BANDS lackiert Champagner Titanio Dark Brown T-BANDS verni champagne Titanio Dark Brown	8.190	8.690
T-STRIPES specchio / T-STRIPES mirror T-STRIPES Spiegel / T-STRIPES miroir	8.740	9.240
T-BANDS specchio / T-BANDS mirror T-BANDS Spiegel / T-BANDS miroir	8.930	9.430

Specificare sempre la finitura dei rivestimenti esterni, la tipologia e finitura delle ante, la finitura dei ripiani in legno e dei divisori interni in vetro
 always specify finish of external coverings, type and finish of doors, finish of wooden shelf and internal glass dividers
 immer Ausführung der Außenbeschichtung angeben, sowie Art und Ausführung der Türe, Ausführung der Holzfücher und internen Glasabteilungen
 spécifier toujours finitions des revêtements extérieurs, le type et finition des portes, finition des étagères en bois et des cloisons en verre

	I	dimensioni	spessore	volume	carico ammesso	peso	prezzo
	E	dimension	thickness	volume	admitted load	weight	price
	D	abmessungen	stärke	volumen	tragfähigkeit	gewicht	preis
	F	dimension	épaisseur	volume	charge admise	poids	prix
		cm	mm	m3	kg	kg	euro

Aterea_Cabinet Optionals

Tonelli design studio 2025

Maggiorazione per finitura riporto top in ceramica / upcharge for top in ceramic / Aufpreis für Top in Keramik / surcharge pour top en céramique

310

Pietra di Savoia antracite bocciardato, Noir desir lucido o opaco, Calacatta oro venato lucido, Pietra Grey opaco, Sahara noir lucido o bocciardato, Travertino bocciardato.
 Pietra di Savoia anthracite bocciardato, Noir desir polished or matt, Calacatta oro venato polished, Pietra Grey matt, Sahara noir polished or bocciardato, Travertino bocciardato.
 Pietra di Savoia Anthrazit bocciardato, Noir desir glänzend oder matt, Calacatta oro venato glänzend, Pietra Grey matt, Sahara noir glänzend oder bocciardato, Travertino bocciardato.
 Pietra di Savoia anthracite mat, Noir desir brillant ou mat, Calacatta oro venato brillant, Pietra Grey mat, Sahar noir brillant ou bocciardato, Travertino bocciardato.

Maggiorazione per finitura riporto top in marmo SPAZZOLATO OPACO / upcharge for top in brushed MATT MARBLE Aufpreis für Top in MATT GEBÜRSTETEM MARMOR /surcharge pour top en MARBRE BROSSE MATT

top marmo Nero Marquinia / marble top Nero Marquinia /Marmortop Nero Marquinia / top marbre Nero Marquinia	1.230
top marmo Bianco Carrara / marble top Bianco Carrara/Marmortop Bianco Carrara / top marbre Bianco Carrara	1.320
top marmo Arabescato Orobico Gold / marble top Arabescato Orobico Gold/Marmortop Arabescato Orobico Gold / top marbre Arabescato Orobico Gold	1.530
top marmo Sahara Noir / marble top Sahara Noir/Marmortop Sahara Noir / top Sahara Noir	1.600
top marmo Tropikal Storm / marble top Tropikal Storm/Marmortop Tropikal Storm / top marbre Tropikal Storm/	1.780
top marmo Domus White / marble top Domus White/Marmortop Domus White / top marbre Domus White	1.910
top marmo Travertino Romano / marble top Travertino Romano / Marmortop Travertino Romano / top marbre Travertino Romano	1.670

- Cabinet con struttura interna in legno e partizioni interne in legno **SIBERIAN ASH, EUCALIPTO o NOCE CANALETTO** e vetro extrachiaro, fumè o bronzo.

Rivestimenti esterni in vetro extrachiaro (effetto lucido) o extrachiaro satinato (effetto opaco), retrolaccato champagne, Titanio o Dark Brown. Optional riporto top in ceramica o marmo.

Ante battenti rivestite a: **Specchio liscio** finiture specchio **standard, fumè o bronzo** oppure in vetro nelle varianti:

Vetro T-Bands specchio standard, fumè o bronzo,

Vetro T-Stripes specchio fumè o bronzo

Vetro T-Bands retrolaccato champagne, Titanio, Dark Brown o RAL.

Piedi in vetro saldato extrachiaro, fumè o bronzo. Kit illuminazione LED verticale interna con sensore, incluso.

- Sideboard with internal structure in wood and internal partitions in wood **SIBERIAN ASH, EUCALIPTO or CANALETTO WALNUT** and glass extra clear, smoked or bronze.

External coverings in extra clear glass (polished effect) or extra clear frosted glass (matt effect), backlacquered champagne, Titanio or Dark Brown.

Optional countertop in ceramic or marble.

Flap doors with coverings in: **Flat mirror** finish **standard, smoked or bronze** or with glass in following variations:

Glass T-Bands standard, smoked or bronze mirror.

Glass T-Stripes smoked or bronze mirror.

Glass T-Bands backlacquered champagne, Titanio, Dark Brown or RAL.

Feet in welded glass extra clear, smoked or bronze. Internal vertical LED lighting kit with sensor, included.

- Sideboard mit Innenstruktur aus Holz und innere Trennelemente aus Holz **SIBERIAN ASH, EUCALIPTO oder WALNUSS CANALETTO** und Glas extrahell, Rauchglas oder Bronze Glas.

Außenverkleidungen aus extrahellem Glas (glänzender Effekt) oder extrahell geätzt (matt Effekt), hinter lackiert Champagner, Titanio oder Dark Brown.

Optionaler Top aus Keramik oder Marmor.

Flügeltüre beschichtet mit: **Glatter Spiegel** Ausführung **standard, Rauchfarbe oder Bronze.**

Glass T-Bands standard, Rauchfarbe oder Bronze Spiegel.

Glass T-Stripes Rauchfarbe oder Bronze Spiegel.

Glass T-Bands hinter lackiert Champagner, Titanio, Dark Brown oder RAL.

Füße aus geschweißtem Glas extrahell, Rauchfarbe oder Bronze. Inklusive internes senkrechtes LED Beleuchtungssystem mit Sensor.

- Sideboard avec structure intérieur en bois et partitions intérieures en bois **SIBERIAN ASH, EUCALIPTO ou NOYER CANALETTO** et verre extra clair, fumé ou bronze.

Revêtements externes en verre extra clair (effet brillant) ou extra clair mordancé (effet mat), retroverni champagne, Titanio ou Dark Brown.

Optionnel top en céramique ou marbre.

Portes battantes recouvertes en: **Miroir lisse** en finition **standard, fumé ou bronze**, ou en verre dans les finitions suivants:

Verre T-Bands miroir standard, fumé ou bronze.

Verre T-Stripes miroir fumé ou bronze.

Verre T-Bands retroverni champagne, Titanio, Dark Brown ou RAL.

Pieds en verre soudé extra clair, fumé ou bronze. Kit éclairage LED vertical intérieur avec capteur, inclus.

	I E D F	dimensioni dimension abmessungen dimension	spessore thickness stärke épaisseur	volume volume volumen volume	carico ammesso admitted load tragfähigkeit charge admise	peso weight gewicht poids	prezzo price preis prix
		cm	mm	m3	kg	kg	euro

Aterea_Cabinet

C3 120 x 49 x h 159

C4 120 x 49 x h 173

1,73

1,88

80 + 15 *

80 + 15 *

303

330

Tonelli design studio 2025

C3

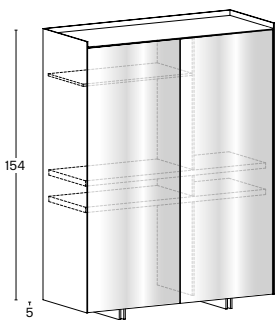

C4

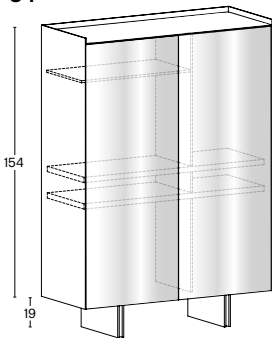

* ogni ripiano / on each shelf / auf jedem Bord / pour chaque étagère

Maggiorazione per finitura laccato RAL opaco su struttura e ante T-Bands
 Surcharge for matt RAL lacquered finish on structure and doors T-Bands
 Aufpreis für matte RAL Lackierung von Struktur und Türen T-Bands
 Supplément pour finition laquée mate RAL sur la structure et les portes T-Bands

+ 10%

C3	RIVESTIMENTI ESTERNI / EXTERNAL COVERINGS / AUSSEN BESCHICHTUNG / REVÊTEMENTS EXTÉRIEURS	
ANTE / DOORS / TÜRE / PORTES	vetro extrachiaro laccato champagne Titanio Dark Brown extra clear glass lacquered champagne Titanio Dark Brown extrahelles Glas lackiert Champagner Titanio Dark Brown verre extra clair verni champagne Titanio Dark Brown	vetro extrachiaro satinato laccato champagne Titanio Dark Brown extra clear frosted glass lacquered champagne Titanio Dark Brown extrahell geätztes Glas lackiert Champagner Titanio Dark Brown verre extra clair mordancé verni champagne Titanio Dark Brown
SPECCHIO liscio / flat MIRROR Glatter SPIEGEL / MIROIR lisse	8.290	8.830
T-BANDS laccato champagne Titanio Dark Brown T-BANDS lacquered champagne Titanio Dark Brown T-BANDS lackiert Champagner Titanio Dark Brown T-BANDS verni champagne Titanio Dark Brown	8.750	9.290
T-STRIPES specchio / T-STRIPES mirror T-STRIPES Spiegel / T-STRIPES miroir	9.630	10.170
T-BANDS specchio / T-BANDS mirror T-BANDS Spiegel / T-BANDS miroir	9.880	10.420

Specificare sempre la finitura dei rivestimenti esterni, la tipologia e finitura delle ante, la finitura dei ripiani in legno e dei divisori interni in vetro
 always specify finish of external coverings, type and finish of doors, finish of wooden shelf and internal glass dividers
 immer Ausführung der Außenbeschichtung angeben, sowie Art und Ausführung der Türe, Ausführung der Holzfücher und internen Glasabteilungen
 spécifier toujours finitions des revêtements extérieurs, le type et finition des portes, finition des étagères en bois et des cloisons en verre

C4	RIVESTIMENTI ESTERNI / EXTERNAL COVERINGS / AUSSEN BESCHICHTUNG / REVÊTEMENTS EXTÉRIEURS	
ANTE / DOORS / TÜRE / PORTES	vetro extrachiaro laccato champagne Titanio Dark Brown extra clear glass lacquered champagne Titanio Dark Brown extrahelles Glas lackiert Champagner Titanio Dark Brown verre extra clair verni champagne Titanio Dark Brown	vetro extrachiaro satinato laccato champagne Titanio Dark Brown extra clear frosted glass lacquered champagne Titanio Dark Brown extrahell geätztes Glas lackiert Champagner Titanio Dark Brown verre extra clair mordancé verni champagne Titanio Dark Brown
SPECCHIO liscio / flat MIRROR Glatter SPIEGEL / MIROIR lisse	8.440	8.980
T-BANDS laccato champagne Titanio Dark Brown T-BANDS lacquered champagne Titanio Dark Brown T-BANDS lackiert Champagner Titanio Dark Brown T-BANDS verni champagne Titanio Dark Brown	8.900	9.440
T-STRIPES specchio / T-STRIPES mirror T-STRIPES Spiegel / T-STRIPES miroir	9.780	10.320
T-BANDS specchio / T-BANDS mirror T-BANDS Spiegel / T-BANDS miroir	10.030	10.570

Specificare sempre la finitura dei rivestimenti esterni, la tipologia e finitura delle ante, la finitura dei ripiani in legno e dei divisori interni in vetro
 always specify finish of external coverings, type and finish of doors, finish of wooden shelf and internal glass dividers
 immer Ausführung der Außenbeschichtung angeben, sowie Art und Ausführung der Türe, Ausführung der Holzfücher und internen Glasabteilungen
 spécifier toujours finitions des revêtements extérieurs, le type et finition des portes, finition des étagères en bois et des cloisons en verre

	I	dimensioni	spessore	volume	carico ammesso	peso	prezzo
	E	dimension	thickness	volume	admitted load	weight	price
	D	abmessungen	stärke	volumen	tragfähigkeit	gewicht	preis
	F	dimension	épaisseur	volume	charge admise	poids	prix
		cm	mm	m3	kg	kg	euro

Aterea_Cabinet Optionals

Tonelli design studio 2025

Maggiorazione per finitura riporto top in ceramica / upcharge for top in ceramic / Aufpreis für Top in Keramik / surcharge pour top en céramique

310

Pietra di Savoia antracite bocciardato, Noir desir lucido o opaco, Emperador lucido o opaco, Calacatta oro venato lucido, Pietra Grey opaco, Sahara noir lucido o bocciardato, Travertino bocciardato.
 Pietra di Savoia anthracite bocciardato, Noir desir polished or matt, Emperador polished or matt, Calacatta oro venato polished, Pietra Grey matt, Sahara noir polished or bocciardato, Travertino bocciardato.
 Pietra di Savoia Anthrazit bocciardato, Noir desir glänzend oder matt, Emperador glänzend oder matt, Calacatta oro venato glänzend, Pietra Grey matt, Sahara noir glänzend oder bocciardato, Travertino bocciardato.
 Pietra di Savoia anthracite mat, Noir desir brillant ou mat, Emperador brillant ou mat, Calacatta oro venato brillant, Pietra Grey mat, Sahar noir brillant ou bocciardato, Travertino bocciardato.

Maggiorazione per finitura riporto top in marmo SPAZZOLATO OPACO / upcharge for top in brushed MATT MARBLE Aufpreis für Top in MATT GEBÜRSTETEM MARMOR /surcharge pour top en MARBRE BROSSE MATT

top marmo Nero Marquinia / marble top Nero Marquinia /Marmortop Nero Marquinia / top marbre Nero Marquinia	1.230
top marmo Bianco Carrara / marble top Bianco Carrara/Marmortop Bianco Carrara / top marbre Bianco Carrara	1.320
top marmo Arabescato Orobico Gold / marble top Arabescato Orobico Gold/Marmortop Arabescato Orobico Gold / top marbre Arabescato Orobico Gold	1.530
top marmo Sahara Noir / marble top Sahara Noir/Marmortop Sahara Noir / top Sahara Noir	1.600
top marmo Tropikal Storm / marble top Tropikal Storm/Marmortop Tropikal Storm / top marbre Tropikal Storm/	1.780
top marmo Domus White / marble top Domus White/Marmortop Domus White / top marbre Domus White	1.910
top marmo Travertino Romano / marble top Travertino Romano / Marmortop Travertino Romano / top marbre Travertino Romano	1.670

- Cabinet con struttura interna in legno e partizioni interne in legno **SIBERIAN ASH, EUCALIPTO o NOCE CANALETTO** e vetro extrachiaro, fumè o bronzo.

Rivestimenti esterni in vetro extrachiaro (effetto lucido) o extrachiaro satinato (effetto opaco), retrolaccato champagne, Titanio o Dark Brown. Optional riporto top in ceramica o marmo.

Ante battenti rivestite a: **Specchio liscio** finiture specchio **standard, fumè o bronzo** oppure in vetro nelle varianti:

Vetro T-Bands specchio standard, fumè o bronzo,

Vetro T-Stripes specchio fumè o bronzo

Vetro T-Bands retrolaccato champagne, Titanio, Dark Brown o RAL.

Piedi in vetro saldato extrachiaro, fumè o bronzo. Kit illuminazione LED verticale interna con sensore, incluso.

- Sideboard with internal structure in wood and internal partitions in wood **SIBERIAN ASH, EUCALIPTO or CANALETTO WALNUT** and glass extra clear, smoked or bronze.

External coverings in extra clear glass (polished effect) or extra clear frosted glass (matt effect), backlacquered champagne, Titanio or Dark Brown.

Optional countertop in ceramic or marble.

Flap doors with coverings in: **Flat mirror** finish **standard, smoked or bronze** or with glass in following variations:

Glass T-Bands standard, smoked or bronze mirror.

Glass T-Stripes smoked or bronze mirror.

Glass T-Bands backlacquered champagne, Titanio, Dark Brown or RAL.

Feet in welded glass extra clear, smoked or bronze. Internal vertical LED lighting kit with sensor, included.

- Sideboard mit Innenstruktur aus Holz und innere Trennelemente aus Holz **SIBERIAN ASH, EUCALIPTO oder WALNUSS CANALETTO** und Glas extrahell, Rauchglas oder Bronze Glas.

Außenverkleidungen aus extrahellem Glas (glänzender Effekt) oder extrahell geätzt (matt Effekt), hinter lackiert Champagner, Titanio oder Dark Brown.

Optionaler Top aus Keramik oder Marmor.

Flügeltüre beschichtet mit: **Glatter Spiegel** Ausführung **standard, Rauchfarbe oder Bronze.**

Glass T-Bands standard, Rauchfarbe oder Bronze Spiegel.

Glass T-Stripes Rauchfarbe oder Bronze Spiegel.

Glass T-Bands hinter lackiert Champagner, Titanio, Dark Brown oder RAL.

Füße aus geschweißtem Glas extrahell, Rauchfarbe oder Bronze. Inklusive internes senkrechtes LED Beleuchtungssystem mit Sensor.

- Sideboard avec structure intérieur en bois et partitions intérieures en bois **SIBERIAN ASH, EUCALIPTO ou NOYER CANALETTO** et verre extra clair, fumé ou bronze.

Revêtements externes en verre extra clair (effet brillant) ou extra clair mordancé (effet mat), retroverni champagne, Titanio ou Dark Brown.

Optionnel top en céramique ou marbre.

Portes battantes recouvertes en: **Miroir lisse** en finition **standard, fumé ou bronze**, ou en verre dans les finitions suivants:

Verre T-Bands miroir standard, fumé ou bronze.

Verre T-Stripes miroir fumé ou bronze.

Verre T-Bands retroverni champagne, Titanio, Dark Brown ou RAL.

Pieds en verre soudé extra clair, fumé ou bronze. Kit éclairage LED vertical intérieur avec capteur, inclus.

	I	dimensioni	spessore	volume	carico ammesso	peso	prezzo
	E	dimension	thickness	volume	admitted load	weight	price
	D	abmessungen	stärke	volumen	tragfähigkeit	gewicht	preis
	F	dimension	épaisseur	volume	charge admise	poids	prix
		cm	mm	m3	kg	kg	euro

Dimora design Debonademeo studio 2026	226 x 47 x h 80		1,14	80 + 15 *	131	▲ 5.480 ○ 6.590
---	-----------------	--	------	-----------	-----	--------------------

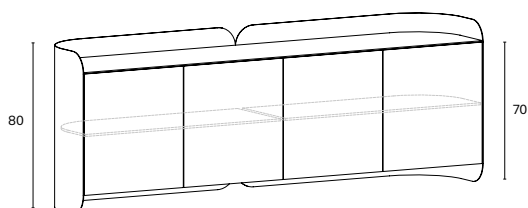

- ▲ Ante in legno laccate opaco Champagne, Titanio, Dark Brown o Platino
wooden doors matt lacquered Champagne, Titanio, Dark Brown or Platino
mat lackierte Holztüren Champagne, Titanio, Dark Brown oder Platino
portes en bois laqué mat Champagne, Titanio, Dark Brown ou Platino
- Ante in legno Siberian Ash, Eucalipto e Noce Canaletto
Siberian Ash, Eucalipto or Canaletto Walnut wooden doors
Siberian Ash, Eucalipto oder Canaletto Walnuss Holztüren
portes en bois en Siberian Ash, Eucalipto ou Noyer Canaletto

* ogni ripiano / on each shelf / auf jedem Bord / pour chaque étagère

Maggiorazione per finitura laccato RAL opaco per ante
Surcharge for matt RAL lacquered finish for doors
Aufpreis für matte RAL Lackierung von Holztüren
Supplément pour finition laquée mate RAL sur les portes

+ 10%

Specificare sempre la finitura della struttura e la finitura delle ante / always specify finish of structure and doors
immer Ausführung des Strukture und Türen angeben / spécifier toujours finition de la structure et la finition des portes.

Optional kit illuminazione interna luce LED 3000K con sensore / Optional internal LED 3000K lighting with sensor
Optionales Innenbeleuchtungsset mit 3000K LED Leuchte und Sensor / Kit d'éclairage intérieur optionnel avec LED 3000K et capteur.

650

- Madia con struttura in metallo curvato e legno. Metallo nelle finiture Champagne, Titanio, Dark Brown e Bronzo, provvista di un ripiano vetro per vano, posizionabile in tre altezze.
Top, base e ante battenti nelle finiture legno Siberian Ash, Eucalipto e Noce Canaletto o laccato opaco Champagne, Titanio, Dark Brown, Platino o Ral.
Ante battenti con apertura push pull. Optional kit illuminazione interna.
- Sideboard with curved metal and wood structure. Metal in Champagne, Titanio, Dark Brown, and Bronzo finishes, equipped with a glass shelf per compartment, positionable at three heights.
Top, base, and hinged doors in Siberian Ash, Eucalipto and Canaletto Walnut wood finishes or in matt Champagne, Titanio, Dark Brown, Platino or RAL lacquer.
Hinged doors with push-pull opening. Optional internal lighting kit.
- Buffet mit Struktur aus gebogenem Metall und Holz. Metall in Champagne, Titanio, Dark Brown und Bronzo.
Jedes Fach verfügt über einen Glasboden, der in drei Höhen verstellbar ist.
Top, Sockel und Scharnirtüren in Holz Ausführung Siberian Ash, Eucalipto und Canaletto Nussbaum oder matt Champagne, Titanio, Dark Brown, Platino oder RAL lackiert.
Flügeltüren mit Push-Pull-Funktion. Optionale Innenbeleuchtung.
- Buffet à structure courbe en métal et bois. Métal disponible en finitions Champagne, Titanio, Dark brown et Bronzo, avec une étagère en verre par compartiment, réglable sur trois hauteurs. Plateau, piètement et portes à charnières en finitions Sibreian Ash, Eucalypto et Noyer Canaletto, ou laquées mat Champagne, Titanio, Dark Brown, Platino ou RAL. Portes à charnières avec système d'ouverture par simple pression. Kit d'éclairage intérieur en option.

	I E D F	dimensioni dimension abmessungen dimension	spessore thickness stärke épaisseur	volume volume volumen volume	carico ammesso admitted load tragfähigkeit charge admise	peso weight gewicht poids	prezzo price preis prix
		cm	mm	m3	kg	kg	euro

Liber M design Luca Papini 2013/2024	M1 200 x 40 x h 60	10 / 12	0,56	60 + 15 *	104	□ 2.750 ■ 2.860 ■ 3.150
	M2 240 x 40 x h 60	10 / 12	0,67	60 + 15 *	123	□ 3.300 ■ 3.460 ■ 3.670

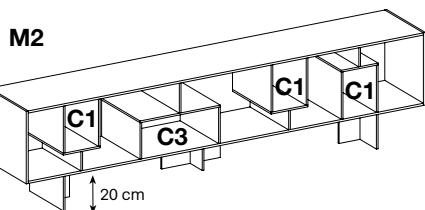
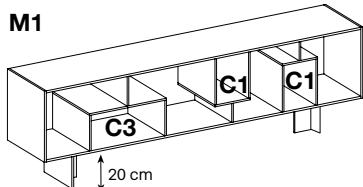

**Optional CASSETTO C1 - C3 / Optional CASSETTO C1 - C3
Opzional CASSETTO C1 - C3 / Optionnel CASSETTO C1 - C3**

- * ogni ripiano / on each shelf / auf jedem Bord / pour chaque étagère
- Vetro extrachiaro / extra clear glass / extrahelles Glas / verre extra clair
 - Vetro fumé / smoked glass / Rauchglas / verre fumé
 - Vetro bronzo / bronze glass / Bronze Glas / Verre bronze

- Madia in vetro con piedi H. 20cm nella stessa finitura. Cassetti optional.
- Glass sideboard with feet h20cm. Optional drawers.
- Sideboard aus Glas mit Füßen H20cm. Optionale Schubladen.
- Sideboard en verre avec pieds h20cm. Tiroirs optionnels.

Liber cassetto design Luca Papini 2013/2022	C1 19 x 40 x h 25		0,03	15	2,5	● 290 ●● 300 ●●● 340 ●●●● 460
	C2 25 x 40 x h 19		0,03	15	2,5	● 290 ●● 300 ●●● 340 ●●●● 460
	C3 45 x 40 x h 19		0,06	15	4,5	● 330 ●● 340 ●●● 360 ●●●● 490

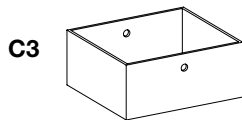
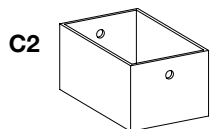
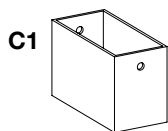

- Cassetto in legno laccato in finitura bianco opaco con foro bifacciale.
- Drawer in matt white lacquered wood with double sided opening.
- Schublade aus Holz matt weiß lackiert mit beidseitiger Öffnung.
- Tiroir en bois laqué mat blanc avec trou biface.

- Cassetto in legno laccato in finitura RAL opaco con foro bifacciale
- Drawer in matt RAL lacquered wood with double sided opening.
- Schublade aus Holz matt RAL lackiert mit beidseitiger Öffnung.
- Tiroir en bois laqué mat RAL avec trou biface.

- Cassetto in legno SIBERIAN ASH, EUCALIPTO e Noce Canaletto con maniglia in pelle.
- Wooden drawer in SIBERIAN ASH, EUCALIPTO and Canaletto Walnut with leather knob.
- Holzschublade aus SIBERIAN ASH, EUCALIPTO und Canaletto Walnuß mit Ledergriff.
- Tiroir en bois SIBERIAN ASH, EUCALIPTO et Noyer Canaletto avec pommeau en cuir.

- Cassetto in cuoio testa di moro con una maniglia.
- Drawer in dark leather with one handle.
- Schublade aus dunklem Leder mit einem Griff.
- Tiroir en cuir Tête-De-Maure avec un pommeau.

	I E D F	dimensioni dimension abmessungen dimension	spessore thickness stärke épaisseur	volume volume volumen volume	carico ammesso admitted load tragfähigkeit charge admise	peso weight gewicht poids	prezzo price preis prix
		cm	mm	m3	kg	kg	euro

Luma design Massimo Castagna 2026	240 x 47 x h 82	4 / 10	1,47	80 + 15 *	252	● 7.900
						●● 7.960
						●●● 7.980

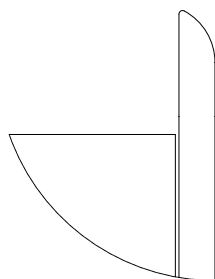
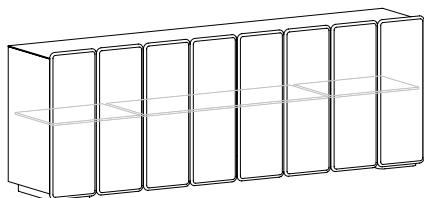

DETTAGLIO SPESSORE ANTA / DOOR THICKNESS DETAIL
DETAIL TÜRSÄRKE / DETAIL ÉPAISSEUR PORTE

Maggiorazione per schienale a specchio uso centro stanza Surcharge for mirrored back for freestanding use Aufpreis für verspiegelte Rückwand bei freistehender Nutzung Supplément pour dos miroir pour utilisation autonome	● 530
	●● 560
	●●● 570

* ogni ripiano / on each shelf / auf jedem Bord / pour chaque étagère

- Specchio / Mirror / Spiegel / Miroir
- Specchio fumè / Smoked mirror / Rauchglasspiegel / miroir fumé
- Specchio bronzo / Bronze mirror / Bronze Spiegel / Miroir bronze

- Madia con struttura in legno rivestita esternamente in specchio nelle finiture specchio, specchio fumè o specchio bronzo. Ante battenti in legno laccate internamente in abbinamento allo specchio della struttura con chiusura soft close e **frontale in specchio di forte spessore** dai bordi smussati in specchio, specchio fumè o bronzo. Ripiani interni in vetro extrachiaro su ogni vano.
- Sideboard with wooden frame covered externally with mirror in clear, smoked or bronze finishes. Wooden hinged doors lacquered internally to match the mirrored frame with soft-close mechanism and **thick mirrored front** with bevelled edges in clear, smoked or bronze mirror finish. Extra-clear glass shelves in each compartment.
- Sideboard mit Holzstruktur und verspiegelten Außenseiten in Spiegel, Rauchglasspiegel oder Bronze Spiegel. Die Holztüren mit Scharnieren sind innen passend zur Struktur lackiert und verfügen über einen Soft-Close-Mechanismus sowie eine **dicke, verspiegelte Front** mit abgeschrägten Kanten in Spiegel, Rauchglas- oder Bronze Spiegel. Jedes Fach ist mit extrahellem Glasböden ausgestattet.
- Buffet à structure en bois revêtue de miroirs, finitions miroir, miroir fumé ou bronze. Portes à charnières en bois laqué à l'intérieur, assorties à la structure, avec système de fermeture amortie et **façade en miroir épais** à bords biseautés, finitions miroir, miroir fumé ou bronze. Étagères en verre extra clair dans chaque compartiment.

	I	dimensioni	spessore	volume	carico ammesso	peso	prezzo
	E	dimension	thickness	volume	admitted load	weight	price
	D	abmessungen	stärke	volumen	tragfähigkeit	gewicht	preis
	F	dimension	épaisseur	volume	charge admise	poids	prix
		cm	mm	m3	kg	kg	euro

Luma design Massimo Castagna 2026	240 x 47 x h 82	4 / 4	1,42	80 + 15 *	205	●	6.710
						●●	6.770
						●●●	6.790

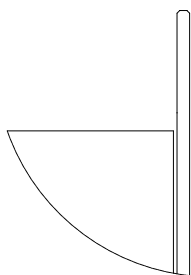
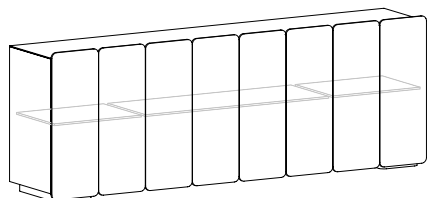

DETTAGLIO SPESSORE ANTA / DOOR THICKNESS DETAIL
DETAIL TÜRSTÄRKE / DETAIL EPAISSEUR PORTE

Maggiorazione per schienale a specchio uso centro stanza	●	530
Surcharge for mirrored back for freestanding use	●●	560
Aufpreis für verspiegelte Rückwand bei freistehender Nutzung	●●●	570
Supplément pour dos miroir pour utilisation autonome	●●●	570

* ogni ripiano / on each shelf / auf jedem Bord / pour chaque étagère

- Specchio / Mirror / Spiegel / Miroir
- Specchio fumè / Smoked mirror / Rauchglasspiegel / miroir fumé
- Specchio bronzo / Bronze mirror / Bronze Spiegel / Miroir bronze

- Madia con struttura in legno rivestita esternamente in specchio nelle finiture specchio, specchio fumè e specchio bronzo. Ante battenti in legno laccate internamente in abbinamento allo specchio della struttura con chiusura soft close e frontale in specchio con spessore ridotto e bordo dritto in specchio, specchio fumè o bronzo. Ripiani interni in vetro extrachiaro su ogni vano.
- Sideboard with wooden frame covered externally with mirror in clear, smoked or bronze finishes. Mirrored frame with soft-close mechanism and a slim mirrored front with a straight edge in mirror, smoked mirror, or bronze mirror. Extra clear glass shelves in each compartment.
- Sideboard mit Holzstruktur und verspiegelten Außenseiten in Spiegel, Rauchglasspiegel oder Bronze Spiegel. Die Holztüren mit Scharnieren sind innen passend zur Struktur lackiert und verfügen über einen Soft-Close-Mechanismus und Spiegelfront mit reduzierter Dicke und gerader Kante in Spiegel, Rauchglas- oder Bronze Spiegel. Jedes Fach ist mit extrahellem Glasböden ausgestattet.
- Buffet à structure en bois revêtu de miroirs, finitions miroir, miroir fumé ou bronze. Portes à charnières en bois laqué à l'intérieur, assorties à la structure, avec système de fermeture amortie et façade en miroir d'épaisseur réduite et à bord droit finitions miroir, miroir fumé ou bronze. Étagères en verre extra clair dans chaque compartiment.

tavoli bassi | coffee tables

	I	dimensioni	spessore	volume	carico ammesso	peso	prezzo
	E	dimension	thickness	volume	admitted load	weight	price
	D	abmessungen	stärke	volumen	tragfähigkeit	gewicht	preis
	F	dimension	épaisseur	volume	charge admise	poids	prix
		cm	mm	m3	kg	kg	euro

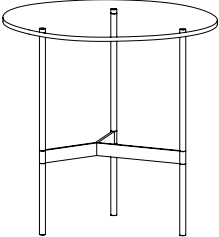
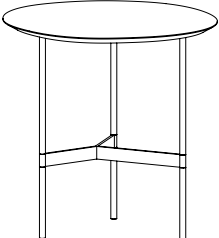
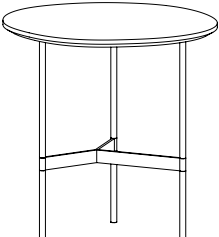
After9 design Massimo Castagna 2020   	50 x 50 x h 30	10	0,059	20	13	□	1.390	
						■	1.400	
							■	1.410
	50 x 50 x h 40	10	0,059	20	13	□	1.410	
							■	1.420
							■	1.430
	50 x 50 x h 50	10	0,059	20	13	□	1.430	
							■	1.440
							■	1.450
□ top vetro extrachiaro / extra clear glass top / Top aus extrahellem Glas / top verre extra clair ■ top vetro fumè / smoked glass top / Top aus Rauchglas / top verre fumé ■ top vetro bronzo / bronze glass top / Top aus Bronze Glas / top verre bronze								
50 x 50 x h 31	16	0,059	20	11	●	1.480		
					●●	1.470		
50 x 50 x h 41	16	0,059	20	11	●	1.500		
					●●	1.490		
50 x 50 x h 51	16	0,059	20	11	●	1.520		
					●●	1.510		
● top legno Siberian Ash / Siberian Ash wood top/ Holztop Siberian Ash / top bois Siberian Ash ●● top legno Eucalipto / Eucalipto wood top/ Holztop Eucalipto / top bois Eucalipto								
50 x 50 x h 31	20	0,059	20	18	▲	1.830		
					▲▲	2.320		
					▲▲▲	2.390		
50 x 50 x h 41	20	0,059	20	18	▲	1.850		
					▲▲	2.350		
					▲▲▲	2.410		
50 x 50 x h 51	20	0,059	20	18	▲	1.870		
					▲▲	2.370		
					▲▲▲	2.430		
▲ top marmo Arabescato Orobico Gold / marble top Arabescato Orobico Gold Marmortop Arabescato Orobico Gold / top marbre Arabescato Orobico Gold ▲▲ top marmo Tropikal Storm / marble top Tropikal Storm Marmortop Tropikal Storm / top marbre Tropikal Storm ▲▲▲ top marmo Domus White / marble top Domus White Marmortop Domus White / top marbre Domus White								

**Specificare sempre la finitura del basamento in metallo / always specify finish of metal base
 Immer Ausführung des Metallgestell angeben / indiquer toujours finition de la base en métal**

- Tavolo basso e fianco divano con struttura in metallo. Supporto superiore, disponibile solo in acciaio inox lucidato, telaio e supporto inferiore, disponibili nelle finiture: cromato, oro, canna di fucile, lucide o spazzolate. Top in vetro (extrachiaro, fumè o bronzo), legno (Siberian Ash o Eucalipto) o marmo **SPAZZOLATO OPACO** (Arabescato Orobico Gold, Tropikal Storm o Domus White).

- Low table and side table with metal structure. Upper support available only in polished stainless steel, frame and lower support available in following finishes: chrome, gold, gunmetal, polished or brushed. Top in glass (extra clear, smoked or bronze), wood (Siberian Ash or Eucalipto) or **BRUSHED MATT** marble (Arabescato Orobico Gold, Tropikal Storm or Domus White).

- Couchtisch und Beistelltisch mit Metallstruktur. Oberes Gestell nur in poliertem Edelstahl, unteres Gestell in folgenden Ausführungen: verchromt, gold, gunmetal, glänzend oder gebürstet. Top aus Glas (extrahell, Rauchglas oder bronze), Holz (Siberian Ash oder Eucalipto) oder **MATT GEBÜRSTETEM** Marmor (Arabescato Orobico Gold, Tropikal Storm oder Domus White).

- Table bas et table de chevet avec structure en métal. Support supérieur disponible seulement en acier inox. Armature et support inférieur disponible en finition : chrome, or, gunmetal, brillant ou brossé. Top en verre (extra clair, fumé ou bronze), bois (Siberian Ash ou Eucalipto) ou marbre **BROSSÉ MATT** (Arabescato Orobico Gold, Tropikal Storm ou Domus White).

	I	dimensioni	spessore	volume	carico ammesso	peso	prezzo
	E	dimension	thickness	volume	admitted load	weight	price
	D	abmessungen	stärke	volumen	tragfähigkeit	gewicht	preis
	F	dimension	épaisseur	volume	charge admise	poids	prix
		cm	mm	m3	kg	kg	euro

After9

design Massimo Castagna 2020

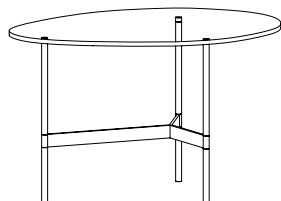

65 x 45 x h 30	10	0,064	20	15	□	1.450
					■	1.460
					■	1.470

65 x 45 x h 40	10	0,064	20	15	□	1.470
					■	1.480
					■	1.490

65 x 45 x h 50	10	0,064	20	15	□	1.490
					■	1.500
					■	1.510

- top vetro extrachiaro / extra clear glass top / Top aus extrahellem Glas / top verre extra clair
- top vetro fumè / smoked glass top / Top aus Rauchglas / top verre fumé
- top vetro bronzo / bronze glass top / Top aus Bronze Glas / top verre bronze

65 x 45 x h 31	16	0,064	20	12	●	1.610
					●●	1.600

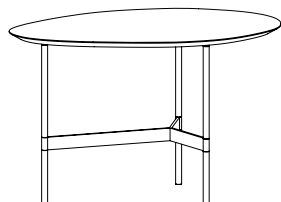

65 x 45 x h 41	16	0,064	20	12	●	1.630
					●●	1.620

65 x 45 x h 51	16	0,064	20	12	●	1.650
					●●	1.640

- top legno Siberian Ash / Siberian Ash wood top/ Holztop Siberian Ash / top bois Siberian Ash
- top legno Eucalipto / Eucalipto wood top/ Holztop Eucalipto / top bois Eucalipto

65 x 45 x h 31	20	0,064	20	21	▲	1.980
					▲▲	2.390
					▲▲▲	2.460

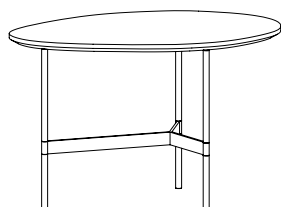

65 x 45 x h 41	20	0,064	20	21	▲	2.000
					▲▲	2.410
					▲▲▲	2.480

65 x 45 x h51	20	0,064	20	21	▲	2.020
					▲▲	2.430
					▲▲▲	2.500

- ▲ top marmo Arabescato Orobico Gold / marble top Arabescato Orobico Gold
- Marmortop Arabescato Orobico Gold / top marbre Arabescato Orobico Gold
- ▲▲ top marmo Tropikal Storm / marble top Tropikal Storm
- Marmortop Tropikal Storm / top marbre Tropikal Storm
- ▲▲▲ top marmo Domus White / marble top Domus White
- Marmortop Domus White / top marbre Domus White

Specificare sempre la finitura del basamento in metallo / always specify finish of metal base
Immer Ausführung des Metallgestell angeben / indiquer toujours finition de la base en métal

- Tavolo basso e fianco divano con struttura in metallo. Supporto superiore, disponibile solo in acciaio inox lucidato, telaio e supporto inferiore, disponibili nelle finiture: cromato, oro, canna di fucile, lucide o spazzolate. Top in vetro (extrachiaro, fumè o bronzo), legno (Siberian Ash o Eucalipto) o marmo **SPAZZOLATO OPACO** (Arabescato Orobico Gold, Tropikal Storm o Domus White).

- Low table and side table with metal structure. Upper support available only in polished stainless steel, frame and lower support available in following finishes: chrome, gold, gunmetal, polished or brushed. Top in glass (extra clear, smoked or bronze), wood (Siberian Ash or Eucalipto) or **BRUSHED MATT** marble (Arabescato Orobico Gold, Tropikal Storm or Domus White).

- Couchtisch und Beistelltisch mit Metallstruktur. Oberes Gestell nur in poliertem Edelstahl, unteres Gestell in folgenden Ausführungen: verchromt, gold, gunmetal, glänzend oder gebürstet. Top aus Glas (extrahell, Rauchglas oder bronze), Holz (Siberian Ash oder Eucalipto) oder **MATT GEBÜRSTETEM** Marmor (Arabescato Orobico Gold, Tropikal Storm oder Domus White).

- Table bas et table de chevet avec structure en métal. Support supérieur disponible seulement en acier inox. Armature et support inférieur disponible en finition : chrome, or, gunmetal, brillant ou brossé. Top en verre (extra clair, fumé ou bronze), bois (Siberian Ash ou Eucalipto) ou marbre **BROSSÉ MATT** (Arabescato Orobico Gold, Tropikal Storm ou Domus White).

	I	dimensioni	spessore	volume	carico ammesso	peso	prezzo
	E	dimension	thickness	volume	admitted load	weight	price
	D	abmessungen	stärke	volumen	tragfähigkeit	gewicht	preis
	F	dimension	épaisseur	volume	charge admise	poids	prix
		cm	mm	m3	kg	kg	euro

After9 design Massimo Castagna 2020	75x60 x h 20	10	0,077	30	20	□	1.480
						■	1.490
						■	1.500

	75x60 x h 30	10	0,077	30	20	□	1.500
						■	1.510
						■	1.520

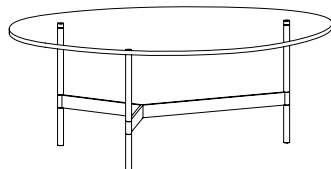

	75x60 x h 40	10	0,077	30	20	□	1.520
						■	1.530
						■	1.540

- top vetro extrachiaro / extra clear glass top / Top aus extrahellem Glas / top verre extra clair
- top vetro fumè / smoked glass top / Top aus Rauchglas / top verre fumé
- top vetro bronzo / bronze glass top / Top aus Bronze Glas / top verre bronze

	75x60 x h 21	16	0,077	30	14	●	1.650
						●●	1.640

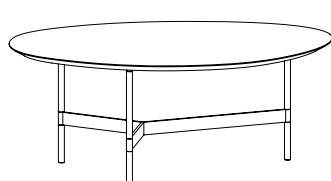

	75x60 x h 31	16	0,077	30	14	●	1.670
						●●	1.660

	75x60 x h 41	16	0,077	30	14	●	1.690
						●●	1.680

- top legno Siberian Ash / Siberian Ash wood top/ Holztop Siberian Ash / top bois Siberian Ash
- top legno Eucalipto / Eucalipto wood top/ Holztop Eucalipto / top bois Eucalipto

	75x60 x h 21	20	0,077	30	30	▲	2.350
						▲▲	2.740
						▲▲▲	2.850

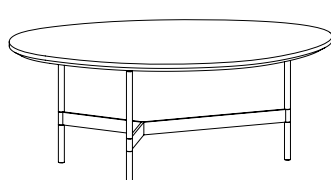

	75x60 x h 31	20	0,077	30	30	▲	2.370
						▲▲	2.760
						▲▲▲	2.870

	75x60 x h 41	20	0,077	30	30	▲	2.390
						▲▲	2.780
						▲▲▲	2.890

- ▲ top marmo Arabescato Orobico Gold / marble top Arabescato Orobico Gold
Marmortop Arabescato Orobico Gold / top marbre Arabescato Orobico Gold
- ▲▲ top marmo Tropikal Storm / marble top Tropikal Storm
Marmortop Tropikal Storm / top marbre Tropikal Storm
- ▲▲▲ top marmo Domus White / marble top Domus White
Marmortop Domus White / top marbre Domus White

**Specificare sempre la finitura del basamento in metallo / always specify finish of metal base
Immer Ausführung des Metallgestell angeben / indiquer toujours finition de la base en métal**

- Tavolo basso e fianco divano con struttura in metallo. Supporto superiore, disponibile solo in acciaio inox lucidato, telaio e supporto inferiore, disponibili nelle finiture: cromato, oro, canna di fucile, lucide o spazzolate. Top in vetro (extrachiaro, fumè o bronzo), legno (Siberian Ash o Eucalipto) o marmo **SPAZZOLATO OPACO** (Arabescato Orobico Gold, Tropikal Storm o Domus White).
- Low table and side table with metal structure. Upper support available only in polished stainless steel, frame and lower support available in following finishes: chrome, gold, gunmetal, polished or brushed. Top in glass (extra clear, smoked or bronze), wood (Siberian Ash or Eucalipto) or marble **BRUSHED MATT** (Arabescato Orobico Gold, Tropikal Storm or Domus White).
- Couchtisch und Beistelltisch mit Metallstruktur. Oberes Gestell nur in poliertem Edelstahl, unteres Gestell in folgenden Ausführungen: verchromt, gold, gunmetal, glänzend oder gebürstet. Top aus Glas (extrahell, Rauchglas oder bronze), Holz (Siberian Ash oder Eucalipto) oder **MATT GEBÜRSTETEM** Marmor (Arabescato Orobico Gold, Tropikal Storm oder Domus White).
- Table bas et table de chevet avec structure en métal. Support supérieur disponible seulement en acier inox. Armature et support inférieur disponible en finition : chrome, or, gunmetal, brillant ou brossé. Top en verre (extra clair, fumé ou bronze), bois (Siberian Ash ou Eucalipto) ou marbre **BROSSÉ MATT** (Arabescato Orobico Gold, Tropikal Storm ou Domus White).

	I	dimensioni	spessore	volume	carico ammesso	peso	prezzo
	E	dimension	thickness	volume	admitted load	weight	price
	D	abmessungen	stärke	volumen	tragfähigkeit	gewicht	preis
	F	dimension	épaisseur	volume	charge admise	poids	prix
		cm	mm	m3	kg	kg	euro

After9 design Massimo Castagna 2020	130 x 130 x h 20	10	0,286	40	48	□	1.970
						■	1.980
						■	1.990

	130 x 130 x h 30	10	0,286	40	48	□	1.990
						■	2.000
						■	2.010

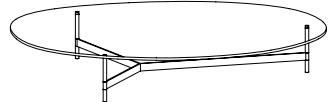

	130 x 130 x h 40	10	0,286	40	48	□	2.010
						■	2.020
						■	2.030

- top vetro extrachiaro / extra clear glass top / Top aus extrahellem Glas / top verre extra clair
- top vetro fumè / smoked glass top / Top aus Rauchglas / top verre fumé
- top vetro bronzo / bronze glass top / Top aus Bronze Glas / top verre bronze

	130 x 130 x h 21	16	0,286	40	31	●	2.640
						●●	2.630

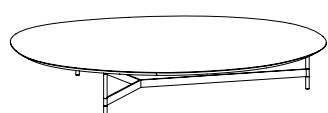

	130 x 130 x h 31	16	0,286	40	31	●	2.660
						●●	2.650

	130 x 130 x h 41	16	0,286	40	31	●	2.680
						●●	2.670

- top legno Siberian Ash / Siberian Ash wood top/ Holztop Siberian Ash / top bois Siberian Ash
- top legno Eucalipto / Eucalipto wood top/ Holztop Eucalipto / top bois Eucalipto

	130 x 130 x h 21	20	0,286	40	65	▲	4.340
						▲▲	4.920
						▲▲▲	5.310

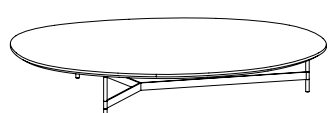

	130 x 130 x h 31	20	0,286	40	65	▲	4.360
						▲▲	4.950
						▲▲▲	5.340

	130 x 130 x h 41	20	0,286	40	65	▲	4.380
						▲▲	4.980
						▲▲▲	5.370

- ▲ top marmo Arabescato Orobico Gold / marble top Arabescato Orobico Gold
Marmortop Arabescato Orobico Gold / top marbre Arabescato Orobico Gold
- ▲▲ top marmo Tropikal Storm / marble top Tropikal Storm
Marmortop Tropikal Storm / top marbre Tropikal Storm
- ▲▲▲ top marmo Domus White / marble top Domus White
Marmortop Domus White / top marbre Domus White

**Specificare sempre la finitura del basamento in metallo / always specify finish of metal base
Immer Ausführung des Metallgestell angeben / indiquer toujours finition de la base en métal**

- Tavolo basso e fianco divano con struttura in metallo. Supporto superiore, disponibile solo in acciaio inox lucidato, telaio e supporto inferiore, disponibili nelle finiture: cromato, oro, canna di fucile, lucide o spazzolate. Top in vetro (extrachiaro, fumè o bronzo), legno (Siberian Ash o Eucalipto) o marmo **SPAZZOLATO OPACO** (Arabescato Orobico Gold, Tropikal Storm o Domus White).
- Low table and side table with metal structure. Upper support available only in polished stainless steel, frame and lower support available in following finishes: chrome, gold, gunmetal, polished or brushed. Top in glass (extra clear, smoked or bronze), wood (Siberian Ash or Eucalipto) or marble **BRUSHED MATT** (Arabescato Orobico Gold, Tropikal Storm or Domus White).
- Couchtisch und Beistelltisch mit Metallstruktur. Oberes Gestell nur in poliertem Edelstahl, unteres Gestell in folgenden Ausführungen: verchromt, gold, gunmetal, glänzend oder gebürstet. Top aus Glas (extrahell, Rauchglas oder bronze), Holz (Siberian Ash oder Eucalipto) oder **MATT GEBÜRSTETEM** Marmor (Arabescato Orobico Gold, Tropikal Storm oder Domus White).
- Table bas et table de chevet avec structure en métal. Support supérieur disponible seulement en acier inox. Armature et support inférieur disponible en finition : chrome, or, gunmetal, brillant ou brossé. Top en verre (extra clair, fumé ou bronze), bois (Siberian Ash ou Eucalipto) ou marbre **BROSSÉ MATT** (Arabescato Orobico Gold, Tropikal Storm ou Domus White).

	I	dimensioni	spessore	volume	carico ammesso	peso	prezzo
	E	dimension	thickness	volume	admitted load	weight	price
	D	abmessungen	stärke	volumen	tragfähigkeit	gewicht	preis
	F	dimension	épaisseur	volume	charge admise	poids	prix
		cm	mm	m3	kg	kg	euro

After9 design Massimo Castagna 2020	50 x 50 x h 31	20	0,059	20	18	▲	1.850
						▲▲	1.950

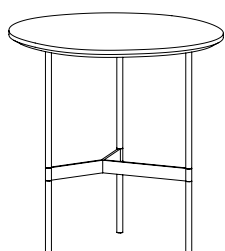

	50 x 50 x h 41	20	0,059	20	18	▲	1.870
						▲▲	1.970
	50 x 50 x h 51	20	0,059	20	18	▲	1.890
						▲▲	1.990

- ▲ top marmo Nero Marquina o Bianco Carrara / marble top Nero Marquina or Bianco Carrara
Marmortop Nero Marquina oder Bianco Carrara / top marbre Nero Marquina ou Bianco Carrara
- ▲▲ top marmo Sahara Noir / marble top Sahara Noir
Marmortop Sahara Noir / top Sahara Noir

	65 x 45 x h 31	20	0,064	20	21	▲	1.890
						▲▲	1.990
	65 x 45 x h 41	20	0,064	20	21	▲	1.910
						▲▲	2.010
	65 x 45 x h 51	20	0,064	20	21	▲	1.930
						▲▲	2.030

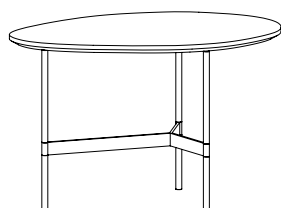

- ▲ top marmo Nero Marquina o Bianco Carrara / marble top Nero Marquina or Bianco Carrara
Marmortop Nero Marquina oder Bianco Carrara / top marbre Nero Marquina ou Bianco Carrara
- ▲▲ top marmo Sahara Noir / marble top Sahara Noir
Marmortop Sahara Noir / top Sahara Noir

**Specificare sempre la finitura del basamento in metallo / always specify finish of metal base
Immer Ausführung des Metallgestell angeben / indiquer toujours finition de la base en métal**

- Tavolo basso e fianco divano con struttura in metallo. Supporto superiore, disponibile solo in acciaio inox lucidato, telaio e supporto inferiore, disponibili nelle finiture: cromato, oro, canna di fucile, lucide o spazzolate.
Top in marmo **LUCIDO** (Nero Marquina, Bianco Carrara o Sahara Noir).
- Low table and side table with metal structure. Upper support available only in polished stainless steel, frame and lower support available in following finishes: chrome, gold, gunmetal, polished or brushed.
Top in **POLISHED** marble (Nero Marquina, Bianco Carrara or Sahara Noir).
- Couchtisch und Beistelltisch mit Metallstruktur. Oberes Gestell nur in poliertem Edelstahl, unteres Gestell in folgenden Ausführungen: verchromt, gold, gunmetal, glänzend oder gebürstet.
Top aus **GLÄNZENDEM** Marmor (Nero Marquina, Bianco Carrara oder Sahara Noir).
- Table bas et table de chevet avec structure en métal. Support supérieur disponible seulement en acier inox. Armature et support inférieur disponible en finition : chrome, or, gunmetal, brillant ou brossé.
Top en marbre **BRILLANT** (Nero Marquina, Bianco Carrara ou Sahara Noir).

	I	dimensioni	spessore	volume	carico ammesso	peso	prezzo
	E	dimension	thickness	volume	admitted load	weight	price
	D	abmessungen	stärke	volumen	tragfähigkeit	gewicht	preis
	F	dimension	épaisseur	volume	charge admise	poids	prix
		cm	mm	m3	kg	kg	euro

After9 design Massimo Castagna 2020	75x60 x h 21	20	0,077	30	30	▲	2.160
						▲▲	2.310

	75x60 x h 31	20	0,077	30	30	▲	2.180
						▲▲	2.330

	75x60 x h 41	20	0,077	30	30	▲	2.200
						▲▲	2.350

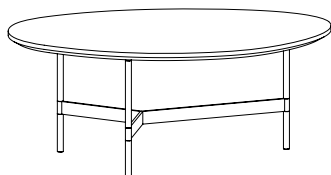

- ▲ top marmo Nero Marquina o Bianco Carrara / marble top Nero Marquina or Bianco Carrara
Marmortop Nero Marquina oder Bianco Carrara / top marbre Nero Marquina ou Bianco Carrara
- ▲▲ top marmo Sahara Noir / marble top Sahara Noir
Marmortop Sahara Noir / top Sahara Noir

	130 x 130 x h 21	20	0,286	40	65	▲	3.800
						▲▲	4.450

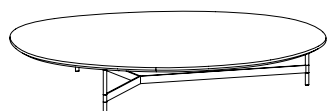

	130 x 130 x h 31	20	0,286	40	65	▲	3.830
						▲▲	4.480

	130 x 130 x h 41	20	0,286	40	65	▲	3.860
						▲▲	4.510

- ▲ top marmo Nero Marquina o Bianco Carrara / marble top Nero Marquina or Bianco Carrara
Marmortop Nero Marquina oder Bianco Carrara / top marbre Nero Marquina ou Bianco Carrara
- ▲▲ top marmo Sahara Noir / marble top Sahara Noir
Marmortop Sahara Noir / top Sahara Noir

**Specificare sempre la finitura del basamento in metallo / always specify finish of metal base
Immer Ausführung des Metallgestell angeben / indiquer toujours finition de la base en métal**

- Tavolo basso e fianco divano con struttura in metallo. Supporto superiore, disponibile solo in acciaio inox lucidato, telaio e supporto inferiore, disponibili nelle finiture: cromato, oro, canna di fucile, lucide o spazzolate.
Top in marmo **LUCIDO** (Nero Marquina, Bianco Carrara o Sahara Noir).
- Low table and side table with metal structure. Upper support available only in polished stainless steel, frame and lower support available in following finishes: chrome, gold, gunmetal, polished or brushed.
Top in **POLISHED** marble (Nero Marquina, Bianco Carrara or Sahara Noir).
- Couchtisch und Beistelltisch mit Metallstruktur. Oberes Gestell nur in poliertem Edelstahl, unteres Gestell in folgenden Ausführungen: verchromt, gold, gunmetal, glänzend oder gebürstet.
Top aus **GLÄNZENDEM** Marmor (Nero Marquina, Bianco Carrara oder Sahara Noir).
- Table bas et table de chevet avec structure en métal. Support supérieur disponible seulement en acier inox. Armature et support inférieur disponible en finition : chrome, or, gunmetal, brillant ou brossé.
Top en marbre **BRILLANT** (Nero Marquina, Bianco Carrara ou Sahara Noir).

	I E D F	dimensioni dimension abmessungen dimension	spessore thickness stärke épaisseur	volume volume volumen volume	carico ammesso admitted load tragfähigkeit charge admise	peso weight gewicht poids	prezzo price preis prix
		cm	mm	m3	kg	kg	euro

After9_fused glass

design Massimo Castagna 2023

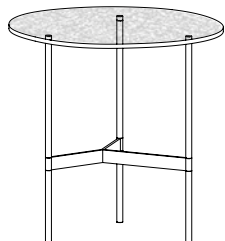

50 x 50 x h 30	10	0,059	20	13	■ 1.840 ■ 1.850
50 x 50 x h 40	10	0,059	20	13	■ 1.860 ■ 1.870
50 x 50 x h 50	10	0,059	20	13	■ 1.880 ■ 1.890

- top vetro fuso fumè / smoked fused glass top / Top aus geschmolzenem Rauchglas top verre en fusion fumé
- top vetro fuso bronzo / fused bronze glass top / Top aus geschmolzenem Bronze Glas top verre en fusion bronze

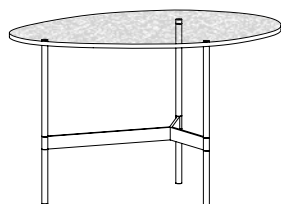

65 x 45 x h 30	10	0,064	20	15	■ 1.930 ■ 1.940
65 x 45 x h 40	10	0,064	20	15	■ 1.950 ■ 1.960
65 x 45 x h 50	10	0,064	20	15	■ 1.970 ■ 1.980

- top vetro fuso fumè / smoked fused glass top / Top aus geschmolzenem Rauchglas top verre en fusion fumé
- top vetro fuso bronzo / fused bronze glass top / Top aus geschmolzenem Bronze Glas top verre en fusion bronze

Specificare sempre la finitura del basamento in metallo / always specify finish of metal base Immer Ausführung des Metallgestell angeben / indiquer toujours finition de la base en métal

- Tavolo basso e fianco divano con struttura in metallo. Supporto superiore, disponibile solo in acciaio inox lucidato, telaio e supporto inferiore, disponibili nelle finiture: cromato, oro, canna di fucile, lucide o spazzolate. Top in vetro fuso fumé e bronzo.
- Low table and side table with metal structure. Upper support available only in polished stainless steel, frame and lower support available in following finishes: chrome, gold, gunmetal, polished or brushed. Top in fused smoked and bronze glass.
- Couchtisch und Beistelltisch mit Metallstruktur. Oberes Gestell nur in poliertem Edelstahl, unteres Gestell in folgenden Ausführungen: verchromt, gold, gunmetal, glänzend oder gebürstet. Top aus geschmolzenem Rauchglas und Bronze Glas.
- Table bas et table de chevet avec structure en métal. Support supérieur disponible seulement en acier inox. Armature et support inférieur disponible en finition : chrome, or, gunmetal, brillant ou brossé. Top en verre en fusion fumé ou bronze.

	I	dimensioni	spessore	volume	carico ammesso	peso	prezzo
	E	dimension	thickness	volume	admitted load	weight	price
	D	abmessungen	stärke	volumen	tragfähigkeit	gewicht	preis
	F	dimension	épaisseur	volume	charge admise	poids	prix
		cm	mm	m3	kg	kg	euro

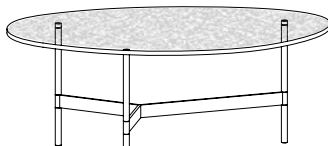
After9_fused glass design Massimo Castagna 2023	75x60 x h 20	10	0,077	30	20	■ 1.950 ■ 1.960
	75x60 x h 30	10	0,077	30	20	■ 1.970 ■ 1.980
	75x60 x h 40	10	0,077	30	20	■ 1.990 ■ 2.000

- top vetro fuso fumè / smoked fused glass top / Top aus geschmolzenem Rauchglas top verre en fusion fumé
- top vetro fuso bronzo / fused bronze glass top / Top aus geschmolzenem Bronze Glas top verre en fusion bronze

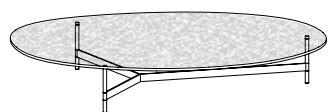
	130x130 x h 20	10	0,286	40	48	■ 2.760 ■ 2.770
	130x130 x h 30	10	0,286	40	48	■ 2.780 ■ 2.790
	130x130 x h 40	10	0,286	40	48	■ 2.800 ■ 2.810

- top vetro fuso fumè / smoked fused glass top / Top aus geschmolzenem Rauchglas top verre en fusion fumé
- top vetro fuso bronzo / fused bronze glass top / Top aus geschmolzenem Bronze Glas top verre en fusion bronze

**Specificare sempre la finitura del basamento in metallo / always specify finish of metal base
Immer Ausführung des Metallgestell angeben / indiquer toujours finition de la base en métal**

- Tavolo basso e fianco divano con struttura in metallo. Supporto superiore, disponibile solo in acciaio inox lucidato, telaio e supporto inferiore, disponibili nelle finiture: cromato, oro, canna di fucile, lucide o spazzolate.
Top in vetro fuso fumé e bronzo.
- Low table and side table with metal structure. Upper support available only in polished stainless steel, frame and lower support available in following finishes: chrome, gold, gunmetal, polished or brushed.
Top in fused smoked and bronze glass.
- Couchtisch und Beistelltisch mit Metallstruktur. Oberes Gestell nur in poliertem Edelstahl, unteres Gestell in folgenden Ausführungen: verchromt, gold, gunmetal, glänzend oder gebürstet.
Top aus geschmolzenem Rauchglas und Bronze Glas.
- Table bas et table de chevet avec structure en métal. Support supérieur disponible seulement en acier inox. Armature et support inférieur disponible en finition : chrome, or, gunmetal, brillant ou brossé.
Top en verre en fusion fumé ou bronze.

	I E D F	dimensioni dimension abmessungen dimension	spessore thickness stärke épaisseur	volume volume volumen volume	carico ammesso admitted load tragfähigkeit charge admise	peso weight gewicht poids	prezzo price preis prix
		cm	mm	m3	kg	kg	euro
Dekon 2		150 x 68 x h 36	12	0,68	30	56	<input type="checkbox"/> 1.470 <input checked="" type="checkbox"/> 1.580 <input type="checkbox"/> 1.780
design Karim Rashid 2006							

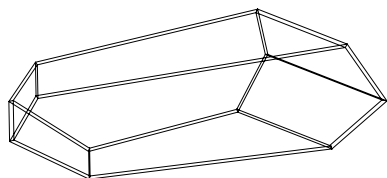

- Vetro extrachiaro / extra clear glass / extrahelles Glas / verre extra clair
- Vetro fumé / smoked glass / Rauchglas / verre fumé
- Vetro bronzo / bronze glass / Bronze Glas / Verre bronze

- Tavolo basso in vetro extrachiaro, fume' o bronzo.
- Small table in extra clear, smoked or bronze glass.
- Niedriger Tisch aus extrahellem Glas, Rauchglas oder Bronze.
- Table basse en verre extra clair, fume ou bronze.

	I E D F	dimensioni dimension abmessungen dimension	spessore thickness stärke épaisseur	volume volume volumen volume	carico ammesso admitted load tragfähigkeit charge admise	peso weight gewicht poids	prezzo price preis prix
		cm	mm	m3	kg	kg	euro

Eden

design Tonelli design studio

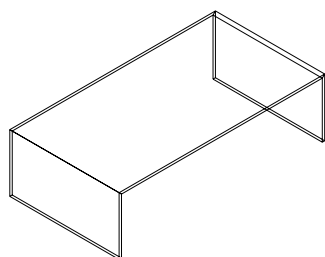

90 x 90 x h 40	12	0,562	50	62	<input type="checkbox"/> 1.130 <input checked="" type="checkbox"/> 1.160 <input type="checkbox"/> 1.230
118 x 88 x h 40	12	0,702	50	72	<input type="checkbox"/> 1.230 <input checked="" type="checkbox"/> 1.270 <input type="checkbox"/> 1.350
128 x 68 x h 40	12	0,596	50	63	<input type="checkbox"/> 1.070 <input checked="" type="checkbox"/> 1.100 <input type="checkbox"/> 1.170
100 x 60 x h 40	12	0,380	50	45	<input type="checkbox"/> 910 <input checked="" type="checkbox"/> 940 <input type="checkbox"/> 990

- Vetro extrachiaro / extra clear glass / extrahelles Glas / verre extra clair
- Vetro fumé / smoked glass / Rauchglas / verre fumé
- Vetro bronzo / bronze glass / Bronze Glas / Verre bronze

- Tavolo a ponte in vetro extrachiaro, fumé o bronzo. Disponibile con dimensioni a richiesta.
 - Small coffee table in extra clear, smoked or bronze glass. Special sizes available.
 - Tisch-Brücke aus extrahellem Glas, Rauchglas oder Bronze. Sondermaße sind möglich.
 - Table basse à pont en verre extra clair, fume ou bronze. Dimensions spéciales sur demande.

Fratina 2

design Tonelli design studio

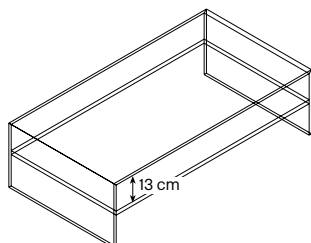

90 x 90 x h 40	12 / 10	0,612	50+20 *	82	<input type="checkbox"/> 1.400 <input checked="" type="checkbox"/> 1.440 <input type="checkbox"/> 1.510
118 x 88 x h 40	12 / 10	0,755	50+20 *	92	<input type="checkbox"/> 1.570 <input checked="" type="checkbox"/> 1.620 <input type="checkbox"/> 1.700
128 x 68 x h 40	12 / 10	0,640	50+20 *	85	<input type="checkbox"/> 1.330 <input checked="" type="checkbox"/> 1.370 <input type="checkbox"/> 1.440
100 x 60 x h 40	12 / 10	0,610	50+20 *	80	<input type="checkbox"/> 1.130 <input checked="" type="checkbox"/> 1.170 <input type="checkbox"/> 1.220

* ogni ripiano / on each shelf / auf jedem Bord / pour chaque étagère

- Vetro extrachiaro / extra clear glass / extrahelles Glas / verre extra clair
- Vetro fumé / smoked glass / Rauchglas / verre fumé
- Vetro bronzo / bronze glass / Bronze Glas / Verre bronze

- Tavolo a ponte con ripiano in vetro extrachiaro, fume' o bronzo. Disponibile con dimensioni a richiesta.
 - Small coffee table with shelf in extra clear, smoked or bronze glass. Special sizes available.
 - Tisch-Brücke mit Ablage aus extrahellem Glas, Rauchglas oder Bronze. Sondermaße sind möglich.
 - Table basse à pont avec double plateau en verre extra clair, fume ou bronze. Dimensions spéciales sur demande.

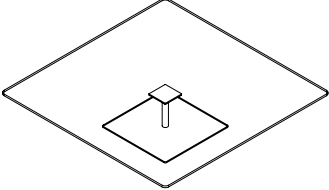
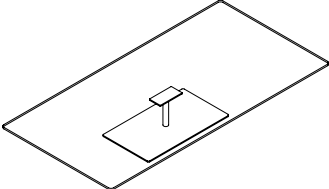
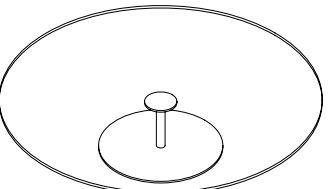
	I E D F	dimensioni dimension abmessungen dimension	spessore thickness stärke épaisseur	volume volume volumen volume	carico ammesso admitted load tragfähigkeit charge admise	peso weight gewicht poids	prezzo price preis prix
		cm	mm	m3	kg	kg	euro
Farniente quadrato design G.T. Garattoni 2002/2024 		90 x 90 x h 24,5	12	0,125	30	50	□ 1.480 ■ 1.510 ■ 1.530
		90 x 90 x h 40	12	0,125	30	55	□ 1.540 ■ 1.570 ■ 1.600
		110 x 110 x h 24,5	12	0,184	30	59	□ 1.680 ■ 1.720 ■ 1.750
		110 x 110 x h 40	12	0,184	30	64	□ 1.740 ■ 1.780 ■ 1.790
Farniente rettangolare design G.T. Garattoni 2002/2024 		130 x 70 x h 24,5	12	0,183	30	60	□ 1.600 ■ 1.630 ■ 1.650
		130 x 70 x h 40	12	0,183	30	65	□ 1.660 ■ 1.690 ■ 1.710
		150 x 80 x h 24,5	12	0,185	30	61	□ 1.750 ■ 1.790 ■ 1.820
		150 x 80 x h 40	12	0,185	30	66	□ 1.810 ■ 1.850 ■ 1.880
Farniente tondo design G.T. Garattoni 2002/2024 		Ø 90 x h 24,5	12	0,125	30	38	□ 1.590 ■ 1.620 ■ 1.640
		Ø 90 x h 40	12	0,125	30	43	□ 1.650 ■ 1.680 ■ 1.700
		Ø 110 x h 24,5	12	0,184	30	47	□ 1.800 ■ 1.840 ■ 1.870
		Ø 110 x h 40	12	0,184	30	52	□ 1.860 ■ 1.900 ■ 1.930
		Ø 120 x h 24,5	12	0,187	30	53	□ 1.840 ■ 1.880 ■ 1.910
		Ø 120 x h 40	12	0,187	30	58	□ 1.900 ■ 1.940 ■ 1.970

Maggiorazione basamento in finitura: **canna di fucile o Champagne**
 Upcharge for base in finish: **gunmetal or Champagne**
 Aufpreis für Gestell aus: **Gunmetal oder Champagne**
 Surcharge pour base en: **canon de fusil ou Champagne**

300

- Vetro extrachiaro / extra clear glass / extrahelles Glas / verre extra clair
- Vetro fumé / smoked glass / Rauchglas / verre fumé
- Vetro bronzo / bronze glass / Bronze Glas / Verre bronze

- Tavolo basso in vetro extrachiaro, fumé o bronzo con basamento in finitura cromata, canna di fucile o Champagne.
- Cocktail table in extra clear, smoked or bronze glass with base in chrome, gunmetal or Champagne finish.
- Couchtisch aus extrahellem Glas, Rauchglas oder Bronze Glas mit Gestell in Chrom, gunmetal oder Champagne.
- Table basse en verre extra clair, fumé ou bronze, piètement en chrome, canon de fusil ou Champagne.

	I E D F	dimensioni dimension abmessungen dimension	spessore thickness stärke épaisseur	volume volume volumen volume	carico ammesso admitted load tragfähigkeit charge admise	peso weight gewicht poids	prezzo price preis prix
		cm	mm	m3	kg	kg	euro
Kat design Karim Rashid 2008	A	88 x 63 x h 36	12	0,41	30	37	<input type="checkbox"/> 1.260 <input checked="" type="checkbox"/> 1.380 <input checked="" type="checkbox"/> 1.420
	B	131 x 74 x h 36	12	0,43	30	41	<input type="checkbox"/> 1.390 <input checked="" type="checkbox"/> 1.530 <input checked="" type="checkbox"/> 1.590

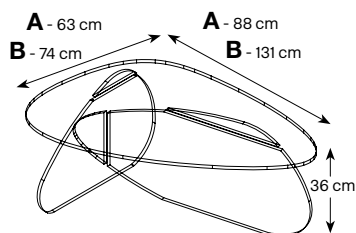

- Vetrol extrachiaro, acidato e fumè / extra clear, frosted and smoked glass
extrahelles Glas, geätztem Glas und Rauchglas / verre extra clair, mordancé et fumé
- Vetrol fumé / smoked glass / Rauchglas / verre fumé
- Vetrol bronzo / bronze glass / Bronze Glas / Verre bronze

- Tavolo basso in vetro extrachiaro, acidato e fumè oppure nelle varianti tutto vetro fumè o tutto vetro bronzo.
- Small table in extra clear, frosted and smoked glass or in the version completely smoked or bronze glass.
- Niedriger Tisch aus extrahellem Glas, geätztem Glas und Rauchglas oder in den Varianten komplett aus Rauchglas oder komplett aus Bronzeglas.
- Table basse en verre extra clair, mordancé et fumé ou dans les variantes entièrement en verre fumé ou entièrement en verre bronze.

	I E D F	dimensioni dimension abmessungen dimension	spessore thickness stärke épaisseur	volume volume volumen volume	carico ammesso admitted load tragfähigkeit charge admise	peso weight gewicht poids	prezzo price preis prix
		cm	mm	m3	kg	kg	euro

Metropolis

design G. Maurizio Scutellà 2017

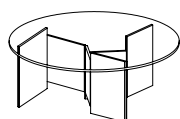
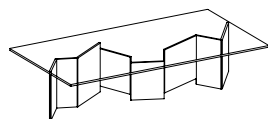

130 x 70 x h 35	12	0,31	50	61	<input type="checkbox"/> 1.340 <input checked="" type="checkbox"/> 1.370 <input checked="" type="checkbox"/> 1.390
150 x 80 x h 35	12	0,48	50	80	<input type="checkbox"/> 1.660 <input checked="" type="checkbox"/> 1.720 <input checked="" type="checkbox"/> 1.740
Ø 90 x h 35	12	0,36	50	49	<input type="checkbox"/> 960 <input checked="" type="checkbox"/> 1.010 <input checked="" type="checkbox"/> 1.030

- basamento e piano vetro extrachiaro / extra clear glass base and top
Gestell und Tischplatte extrahell Glas / piètement et top verre extra clair
- basamento e piano vetro fumè / smoked glass base and top
Gestell und Tischplatte aus Rauchglas / piètement et top verre fumé
- basamento e piano vetro bronzo / bronze glass base and top
Gestell und Tischplatte aus Bronze Glas / piètement et top verre bronze

- Tavolo basso con basamento centrale in vetro extrachiaro, fumè o bronzo.
Top in vetro extrachiaro, fumè o bronzo.
- Low table with central base in extra clear, smoked or bronze glass.
Top in extra clear, smoked or bronze glass.
- Niedriger Tisch mit zentralem Gestell in extrahellem Glas, Rauchglas oder Bronze.
Topplatte aus extrahellem Glas, Rauchglas oder Bronze.
- Table basse avec piètement central en verre extra clair, fumé ou bronze.
Top en verre extra clair ou fumé.

Metropolis ceramic

design G. Maurizio Scutellà 2017

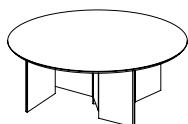
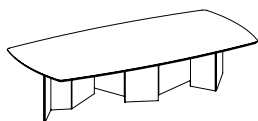

120 x 60 x h 35	12 / 8 + 5	0,29	50	59	<input type="checkbox"/> 1.710 <input checked="" type="checkbox"/> 1.760 <input checked="" type="checkbox"/> 1.790
130 x 70 x h 35	12 / 8 + 5	0,33	50	75	<input type="checkbox"/> 1.880 <input checked="" type="checkbox"/> 1.930 <input checked="" type="checkbox"/> 1.970
160 x 80 x h 35	12 / 8 + 5	0,49	50	89	<input type="checkbox"/> 2.200 <input checked="" type="checkbox"/> 2.260 <input checked="" type="checkbox"/> 2.310
Ø 95 x h 35	12 / 8 + 5	0,37	50	52	<input type="checkbox"/> 1.760 <input checked="" type="checkbox"/> 1.810 <input checked="" type="checkbox"/> 1.840

- basamento in vetro extrachiaro / base in extra clear glass / Gestell aus extrahellem Glas / piètement en verre extra clair
- basamento in vetro fumè / base in smoked glass / Gestell aus Rauchglas / piètement en verre fumé
- basamento in vetro bronzo / base in bronze glass / Gestell aus Bronze Glas / piètement en verre bronze

- Tavolo basso con basamento centrale in vetro extrachiaro, fumè o bronzo. Top in ceramica+vetro nelle seguenti finiture:
Pietra di Savoia antracite bocciardato, Noir desir lucido o opaco, Calacatta oro venato lucido, Pietra Grey opaco, Sahara noir lucido o bocciardato e Travertino.
- Low table with central base in extra clear, smoked or bronze glass. Top made of ceramic+glass with following finishes:
Pietra di Savoia anthracite bushhammered, Noir desir polished or matt, Calacatta oro venato polished, Pietra Grey matt, Sahara noir polished or bushhammered and Travertino.
- Niedriger Tisch mit zentralem Gestell in extrahellem Glas, Rauchglas oder Bronze. Top aus Keramik+Glas in folgenden Ausfertigungen:
Pietra di Savoia Anthrazit bocciardato, Noir desir glänzend oder matt, Calacatta oro venato glänzend, Pietra Grey matt, Sahara noir glänzend oder bocciardato und Travertino.
- Table basse avec piètement central en verre extra clair, fumé ou bronze. Top en céramique+verre dans les suivants finitions:
Pietra di Savoia anthracite bouchardé, Noir desir brillant ou mat, calacatta oro venato brillant, Pietra Grey mat, Sahar noir brillant ou bouchardé et Travertino.

	I	dimensioni	spessore	volume	carico ammesso	peso	prezzo
	E	dimension	thickness	volume	admitted load	weight	price
	D	abmessungen	stärke	volumen	tragfähigkeit	gewicht	preis
	F	dimension	épaisseur	volume	charge admise	poids	prix
		cm	mm	m3	kg	kg	euro

Oasis

Ø 45 x h 45

0,14

15

12

1.180

design Massimo Castagna 2025

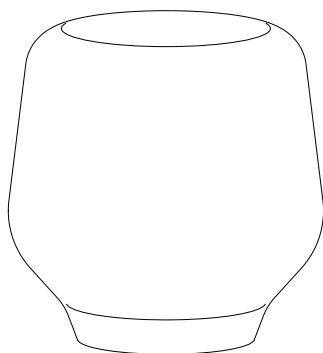

Ø 60 x h 32

0,21

15

14

1.480

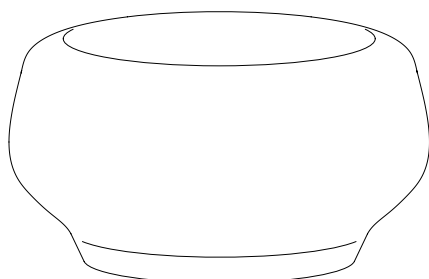

**Specificare sempre la finitura del vetro Ambra scuro, Bronzo, Fumè o Verde Pavone.
Always specify glass finish, dark amber, bronze, smoked or peafowl green
Immer Glasausführung angeben dunkles Amber, bronze, rauchfarbe oder Pfauengrün
Toujours spécifier finition du verre ambre foncé, bronze, fumé ou vert paon**

- Tavolino basso o fianco divano in vetro soffiato di Murano, disponibili in diversi colori.
Ogni pezzo viene soffiato, secondo la tradizionale tecnica, da artigiani del vetro di Murano.
Eventuali imperfezioni dovute alla soffiatura del vetro sono da ritenersi caratteristiche del prodotto e dettagli di qualità e originalità.
- Cocktail table or side table in Murano blown glass, available in several colours.
Each piece is blown, according to the traditional technique, by Murano glass artisans.
Any imperfections due to glass blowing are to be considered characteristics of the product and details of quality and originality.
- Couchtisch oder Beistelltisch aus geblasenem Murano Glas, erhältlich in verschiedenen Farben.
Jedes Stück wird von Murano-Glashandwerkern nach traditioneller Technik geblasen.
Eventuelle Unvollkommenheiten, die durch die Glasbläserei entstehen, sind als Eigenschaften des Produktes und als Angaben zur Qualität und Originalität anzusehen.
- Table bas ou table de chevet en verre soufflé de Murano, disponible en différents couleurs.
Chaque pièce est soufflée, selon la technique traditionnelle, par des artisans verriers de Murano.
Les éventuelles imperfections dues au soufflage du verre doivent être considérées comme des caractéristiques du produit et des détails de qualité et d'originalité.

	I	dimensioni	spessore	volume	carico ammesso	peso	prezzo
	E	dimension	thickness	volume	admitted load	weight	price
	D	abmessungen	stärke	volumen	tragfähigkeit	gewicht	preis
	F	dimension	épaisseur	volume	charge admise	poids	prix
		cm	mm	m3	kg	kg	euro

Plinsky

design Giulio Mancini 2007/2019

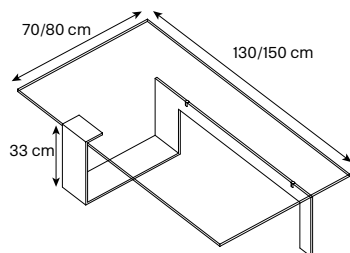

STRUTTURA VERNICIATA NERO / STRUCTURE BLACK LACQUERED / STRUKTUR SCHWARZ LACKIERT / STRUCTURE LAQUE NOIR

130 x 70 x h 33	12	0,42	30	60	<input type="checkbox"/> 1.490 <input checked="" type="checkbox"/> 1.530 <input type="checkbox"/> 1.550
150 x 80 x h 33	12	0,45	30	69	<input type="checkbox"/> 1.590 <input checked="" type="checkbox"/> 1.640 <input type="checkbox"/> 1.670

STRUTTURA VERNICIATA BIANCO / STRUCTURE WHITE LACQUERED / STRUKTUR WEISS LACKIERT / STRUCTURE LAQUE BLANC

130 x 70 x h 33	12	0,42	30	60	<input type="checkbox"/> 1.480 <input checked="" type="checkbox"/> 1.520 <input type="checkbox"/> 1.540
150 x 80 x h 33	12	0,45	30	69	<input type="checkbox"/> 1.580 <input checked="" type="checkbox"/> 1.630 <input type="checkbox"/> 1.660

STRUTTURA CROMATA / STRUCTURE CHROME / STRUKTUR CHROM / STRUCTURE CHROME

130 x 70 x h 33	12	0,42	30	60	<input type="checkbox"/> 1.540 <input checked="" type="checkbox"/> 1.580 <input type="checkbox"/> 1.600
150 x 80 x h 33	12	0,45	30	69	<input type="checkbox"/> 1.640 <input checked="" type="checkbox"/> 1.690 <input type="checkbox"/> 1.720

STRUTTURA CANNA DI FUCILE / GUNMETAL STRUCTURE / GUNMETAL STRUKTUR / STRUCTURE GUNMETAL

130 x 70 x h 33	12	0,42	30	60	<input type="checkbox"/> 1.990 <input checked="" type="checkbox"/> 2.030 <input type="checkbox"/> 2.050
150 x 80 x h 33	12	0,45	30	69	<input type="checkbox"/> 2.090 <input checked="" type="checkbox"/> 2.140 <input type="checkbox"/> 2.170

- Vetro extrachiaro / extra clear glass / extrahelles Glas / verre extra clair
- Vetro fumé / smoked glass / Rauchglas / verre fumé
- Vetro bronzo / bronze glass / Glas Bronze / verre bronze

- Tavolo basso in vetro extrachiaro, fumé o bronzo con basamento in metallo in finitura cromata o canna di fucile, verniciato nero o bianco opaco.
- Cocktail table in extra clear, smoked or bronze glass with metal base in chrome finish or gunmetal, matt black or white lacquered.
- Couchtisch in extrahellem Glas, Rauchglas oder Bronze mit Metallgestell aus Chrom oder Gunmetal, schwarz oder weiß matt lackiert.
- Table basse en verre extra clair, fumé ou bronze avec piètement en métal chromé ou gunmetal, laqué blanc ou noir mat.

	I	dimensioni	spessore	volume	carico ammesso	peso	prezzo
	E	dimension	thickness	volume	admitted load	weight	price
	D	abmessungen	stärke	volumen	tragfähigkeit	gewicht	preis
	F	dimension	épaisseur	volume	charge admise	poids	prix
		cm	mm	m3	kg	kg	euro

Sestante							
 <p>design Emilio Nanni 2019</p>	100 x 100 x h 36	10	0,61	30	70	<input type="checkbox"/> 1.220 <input checked="" type="checkbox"/> 1.280 <input checked="" type="checkbox"/> 1.390	
	130 x 70 x h 36	10	0,56	30	67	<input type="checkbox"/> 1.180 <input checked="" type="checkbox"/> 1.230 <input checked="" type="checkbox"/> 1.350	
	150 x 100 x h 36	10	0,89	30	97	<input type="checkbox"/> 1.580 <input checked="" type="checkbox"/> 1.660 <input checked="" type="checkbox"/> 1.820	
	150 x 150 x h 36	10	1,29	30	127	<input type="checkbox"/> 2.020 <input checked="" type="checkbox"/> 2.110 <input checked="" type="checkbox"/> 2.320	
	150 x 40 x h 42	10	0,45	30	56	<input type="checkbox"/> 1.070 <input checked="" type="checkbox"/> 1.110 <input checked="" type="checkbox"/> 1.220	

- Vetro extrachiaro / extra clear glass / extrahelles Glas / verre extra clair
- Vetro fumé / smoked glass / Rauchglas / verre fumé
- Vetro bronzo / bronze glass / Bronze Glas / Verre bronze

- Tavolo basso in vetro extrachiaro, fumé e bronzo. Disponibile in 5 misure.
 - Low table in extra clear, smoked and bronze. Available in 5 sizes.
 - Couchtisch aus extrahellem Glas, Rauchglas und Bronze. In 5 verschiedenen Maßen erhältlich.
 - Table bas en extra clair, verre fumé et bronze. Disponible en 5 mesures.

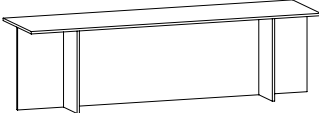
Sestante Panca Bench							
 <p>design Emilio Nanni 2019</p>	150 x 40 x h 42	10	0,45	120	62	<input type="checkbox"/> 1.190 <input checked="" type="checkbox"/> 1.240 <input checked="" type="checkbox"/> 1.360	

- Vetro extrachiaro / extra clear glass / extrahelles Glas / verre extra clair
- Vetro fumé / smoked glass / Rauchglas / verre fumé
- Vetro bronzo / bronze glass / Bronze Glas / Verre bronze

- Panca in vetro extrachiaro, fumé e bronzo.
 - Bench in extra clear, smoked and bronze.
 - Bank aus extrahellem Glas, Rauchglas und Bronze.
 - Banquette en verre extra clair, fumé et bronze.

	I E D F	dimensioni dimension abmessungen dimension	spessore thickness stärke épaisseur	volume volume volumen volume	carico ammesso admitted load tragfähigkeit charge admise	peso weight gewicht poids	prezzo price preis prix
		cm	mm	m3	kg	kg	euro

Sestante

design Emilio Nanni 2023

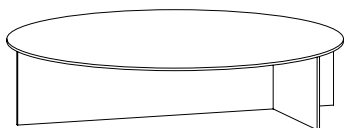

Ø 80 x h 30	10	0,36	30	45	<input type="checkbox"/> 1.000 <input checked="" type="checkbox"/> 1.030 <input type="checkbox"/> 1.130
Ø 80 x h 36	10	0,41	30	48	<input type="checkbox"/> 1.040 <input checked="" type="checkbox"/> 1.080 <input type="checkbox"/> 1.180
Ø 100 x h 30	10	0,54	30	58	<input type="checkbox"/> 1.170 <input checked="" type="checkbox"/> 1.210 <input type="checkbox"/> 1.330
Ø 100 x h 36	10	0,62	30	62	<input type="checkbox"/> 1.210 <input checked="" type="checkbox"/> 1.250 <input type="checkbox"/> 1.380
Ø 130 x h 30	10	0,88	30	79	<input type="checkbox"/> 1.570 <input checked="" type="checkbox"/> 1.630 <input type="checkbox"/> 1.790
Ø 130 x h 36	10	1,00	30	83	<input type="checkbox"/> 1.620 <input checked="" type="checkbox"/> 1.690 <input type="checkbox"/> 1.860
Ø 150 x h 30	10	1,15	30	96	<input type="checkbox"/> 1.860 <input checked="" type="checkbox"/> 1.940 <input type="checkbox"/> 2.130
Ø 150 x h 36	10	1,3	30	100	<input type="checkbox"/> 1.920 <input checked="" type="checkbox"/> 2.010 <input type="checkbox"/> 2.210



130 x 70 x h 30	10	0,50	30	60	<input type="checkbox"/> 1.150 <input checked="" type="checkbox"/> 1.190 <input type="checkbox"/> 1.310
130 x 70 x h 36	10	0,57	30	64	<input type="checkbox"/> 1.200 <input checked="" type="checkbox"/> 1.250 <input type="checkbox"/> 1.380
150 x 80 x h 30	10	0,65	30	74	<input type="checkbox"/> 1.370 <input checked="" type="checkbox"/> 1.430 <input type="checkbox"/> 1.570
150 x 80 x h 36	10	0,73	30	78	<input type="checkbox"/> 1.420 <input checked="" type="checkbox"/> 1.490 <input type="checkbox"/> 1.640
200 x 70 x h 30	10	0,76	30	85	<input type="checkbox"/> 1.650 <input checked="" type="checkbox"/> 1.730 <input type="checkbox"/> 1.900
200 x 70 x h 36	10	0,86	30	90	<input type="checkbox"/> 1.710 <input checked="" type="checkbox"/> 1.800 <input type="checkbox"/> 1.980

- basamento e piano extrachiaro / extra clear base and top
Gestell und Tischplatte extrahell / piètement et top extra clair
- basamento e piano fumè / smoked base and top
Gestell und Tischplatte aus Rauchglas / piètement et top fumé
- basamento e piano bronzo / bronze base and top
Gestell und Tischplatte aus Bronze Glas / piètement et top bronze

- Tavolo basso o fianco divano in vetro extrachiaro, fumè o bronzo.
- Low table or side table in extra clear, smoked or bronze glass.
- Couchtisch oder Beistelltisch aus extrahellem Glas, Rauchglas oder Bronze Glas.
- Table bas ou table de chevet verre en extra clair, fumé ou bronze.

	I E D F	dimensioni dimension abmessungen dimension	spessore thickness stärke épaisseur	volume volume volumen volume	carico ammesso admitted load tragfähigkeit charge admise	peso weight gewicht poids	prezzo price preis prix
		cm	mm	m3	kg	kg	euro
Sestante_Stone design Emilio Nanni 2020		130 x 70 x h 37	10 / 20	0,56	30	90	△ 2.540 ▲ 2.560 △△ 3.370 ▲▲ 3.390 △△△ 4.070 ▲▲▲ 4.090
		100 x 100 x h 37	10 / 20	0,61	30	96	△ 2.630 ▲ 2.650 △△ 3.490 ▲▲ 3.510 △△△ 4.230 ▲▲▲ 4.250
		150 x 100 x h 37	10 / 20	0,89	30	136	△ 3.460 ▲ 3.500 △△ 4.670 ▲▲ 4.710 △△△ 5.680 ▲▲▲ 5.720
	150 x 150 x h 37	10 / 20	1,29	30	185	△ 4.580 ▲ 4.630 △△ 6.170 ▲▲ 6.220 △△△ 7.560 ▲▲▲ 7.610	
	150 x 40 x h 43	10 / 20	0,45	30	72	△ 2.460 ▲ 2.490 △△ 2.880 ▲▲ 3.470 △△△ 3.440 ▲▲▲ 3.910	



- △ base vetro extrachiaro, top marmo Arabescato Orobito Gold
extra clear base, top in Arabescato Orobito Gold marble
Gestell aus extrahellem Glas, Top in Marmor Arabescato Orobito Gold
base en verre extra clair, top en marbre Arabescato Orobito Gold
- △△ base vetro extrachiaro, top marmo Tropikal Storm
extra clear base, top in Tropikal Storm marble
Gestell aus extrahellem Glas, Top in Marmor Tropikal Storm
base en verre extra clair, top en marbre Tropikal Storm
- △△△ base vetro extrachiaro, top marmo Domus White
base en verre extra clair, top in Domus White marble
Gestell aus extrahellem Glas, Top in Marmor Domus White
base en verre extra clair, top en marbre Domus White
-
- ▲ base vetro fumè o bronzo, top marmo Arabescato Orobito Gold
base in smoked or bronze glass, top in Arabescato Orobito Gold marble
Gestell aus Rauchglas oder Bronze Glas, Top in Marmor Arabescato Orobito Gold
base en verre fumé or bronze, top en marbre Arabescato Orobito Gold
- ▲▲ base vetro fumè o bronzo, top marmo Tropikal Storm
base in smoked or bronze glass, top in Tropikal Storm marble
Gestell aus Rauchglas oder Bronze Glas, Top in Marmor Tropikal Storm
base en verre fumé or bronze, top en marbre Tropikal Storm
- ▲▲▲ base vetro fumè o bronzo, top marmo Domus White
base in smoked or bronze glass, top in Domus White marble
Gestell aus Rauchglas oder Bronze Glas, Top in Marmor Domus White
base en verre fumé or bronze, top en marbre Domus White

- Tavolo basso con base in vetro extrachiaro, fumè o bronzo.
Top in marmo bisellato, disponibile in **Arabescato Orobito Gold, Tropikal Storm o Domus white.**
- Coffee table with base in extra clear, smoked or bronze glass.
Top in bevelled marble, available in **Arabescato Orobito Gold, Tropikal Storm or Domus White.**
- Couchtisch mit Gestell aus extrahellem Glas, Rauchglas oder Bronze.
Top in Marmor mit Facettenschliff, erhältlich in **Arabescato Orobito Gold, Tropikal Storm oder Domus White.**
- Table bas avec base en verre extra clair, fumé ou bronze.
Top en marbre biseauté, disponible en **Arabescato Orobito Gold, Tropikal Storm ou Domus White.**

fianco divano | side tables

	I E D F	dimensioni dimension abmessungen dimension	spessore thickness stärke épaisseur	volume volume volumen volume	carico ammesso admitted load tragfähigkeit charge admise	peso weight gewicht poids	prezzo price preis prix
		cm	mm	m3	kg	kg	euro

Bakkarat

design D'Urbino - Lomazzi 2013

Ø 50 x h 45	10 / 20	0,22	20	18	1.060
Ø 60 x h 45	10 / 20	0,3	20	21	1.090
Ø 50 x h 65	10 / 20	0,29	20	20	1.080
Ø 60 x h 65	10 / 20	0,37	20	23	1.120

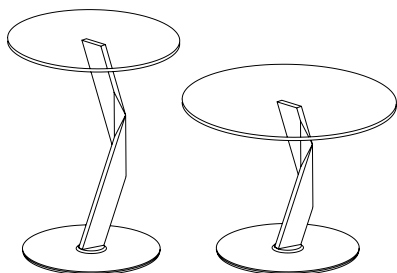

- Tavolino multiuso, gamba in vetro forte spessore, disponibile solo in vetro extrachiaro ed in due diverse altezze.
- Multipurpose table, leg in thick glass, available only in extra clear glass and in two different heights.
- Mehrzwecktisch, Bein aus starkem Glas, nur in extrahellem Glas und in zwei verschiedenen Höhen erhältlich.
- Table à usages multiples, pied en verre de fort épaisseur, disponible seulement en verre extra clair et en deux différents hauteurs.

Il paese delle meraviglie

design Paolo Lomazzi 2018

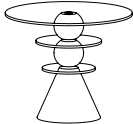
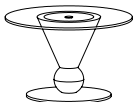
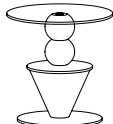
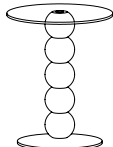
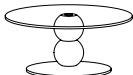
Turchina		Ø 60 x h 52	10	0,30	20	31	1.520
Cenerentola		Ø 60 x h 52	10	0,30	20	31	1.580
Maramao		Ø 60 x h 38	10	0,21	20	29	1.390
Marameo		Ø 50 x h 52	10	0,30	20	31	1.590
Alice alta		Ø 50 x h 63	10	0,30	20	28	1.730
Alice bassa		Ø 60 x h 27	10	0,17	29	22	1.080

- Serie di tavolini. Piani orizzontali in vetro, struttura realizzata con miscela di frammenti di vetro neutro o colorato.
- Series of small tables. Horizontal panels in glass, structure made of a mix of glass shards in neutral or coloured glass.
- Vielzahl von kleinen Tischen. Horizontale Platten aus Glas, Struktur ist ein Mix von neutralen oder farbigen Glasscherben.
- Série de petites tables. Panneaux horizontals en verre. Structure réalisé avec un mélange de fragments de verre neutre ou coloré.

	I	dimensioni	spessore	volume	carico ammesso	peso	prezzo
	E	dimension	thickness	volume	admitted load	weight	price
	D	abmessungen	stärke	volumen	tragfähigkeit	gewicht	preis
	F	dimension	épaisseur	volume	charge admise	poids	prix
		cm	mm	m3	kg	kg	euro

Joliet

design Giulio Mancini 2011 / 2019

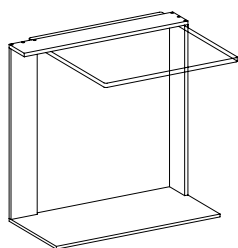

STRUTTURA VERNICIATA NERO / STRUCTURE BLACK LACQUERED / STRUKTUR SCHWARZ LACKIERT / STRUCTURE LAQUÉ NOIR							
50 x 40 x h 50	12	0,08	20	23	<input type="checkbox"/>	1.080	<input type="checkbox"/>
					<input checked="" type="checkbox"/>	1.090	<input checked="" type="checkbox"/>
					<input type="checkbox"/>	1.100	<input type="checkbox"/>
50 x 40 x h 65	12	0,1	20	24	<input type="checkbox"/>	1.200	<input type="checkbox"/>
					<input checked="" type="checkbox"/>	1.210	<input checked="" type="checkbox"/>
					<input type="checkbox"/>	1.220	<input type="checkbox"/>
STRUTTURA VERNICIATA BIANCO / STRUCTURE WHITE LACQUERED / STRUKTUR WEISS LACKIERT / STRUCTURE LAQUÉ BLANC							
50 x 40 x h 50	12	0,08	20	23	<input type="checkbox"/>	1.080	<input type="checkbox"/>
					<input checked="" type="checkbox"/>	1.090	<input checked="" type="checkbox"/>
					<input type="checkbox"/>	1.100	<input type="checkbox"/>
50 x 40 x h 65	12	0,1	20	24	<input type="checkbox"/>	1.200	<input type="checkbox"/>
					<input checked="" type="checkbox"/>	1.210	<input checked="" type="checkbox"/>
					<input type="checkbox"/>	1.220	<input type="checkbox"/>
STRUTTURA CROMATA / STRUCTURE CHROME / STRUKTUR CHROM / STRUCTURE CHROMÈ							
50 x 40 x h 50	12	0,08	20	23	<input type="checkbox"/>	1.280	<input type="checkbox"/>
					<input checked="" type="checkbox"/>	1.290	<input checked="" type="checkbox"/>
					<input type="checkbox"/>	1.300	<input type="checkbox"/>
50 x 40 x h 65	12	0,1	20	24	<input type="checkbox"/>	1.400	<input type="checkbox"/>
					<input checked="" type="checkbox"/>	1.410	<input checked="" type="checkbox"/>
					<input type="checkbox"/>	1.420	<input type="checkbox"/>
STRUTTURA CANNA DI FUCILE / GUNMETAL STRUCTURE / GUNMETAL STRUKTUR / STRUCTURE GUNMETAL							
50 x 40 x h 50	12	0,08	20	23	<input type="checkbox"/>	1.410	<input type="checkbox"/>
					<input checked="" type="checkbox"/>	1.420	<input checked="" type="checkbox"/>
					<input type="checkbox"/>	1.430	<input type="checkbox"/>
50 x 40 x h 65	12	0,1	20	24	<input type="checkbox"/>	1.530	<input type="checkbox"/>
					<input checked="" type="checkbox"/>	1.540	<input checked="" type="checkbox"/>
					<input type="checkbox"/>	1.550	<input type="checkbox"/>

- Vetro extrachiaro / extra clear glass / extrahelles Glas / verre extra clair
- Vetro fumé / smoked glass / Rauchglas / verre fumé
- Vetro bronzo / bronze glass / Glas Bronze / verre bronze

- Fianco divano o comodino in vetro extrachiaro, fumé o bronzo con basamento in metallo in finitura cromata o canna di fucile, verniciato nero o bianco opaco.
- Side table or bedside in extra clear, smoked or bronze glass with metal base in chrome finish or gunmetal, matt black or white lacquered.
- Beistelltisch oder Nachttisch in extrahellem Glas, Rauchglas oder Bronze mit Metallgestell aus Chrom oder Gunmetal, schwarz oder weiß matt lackiert.
- Table de chevet ou table de nuit en verre extra clair, fumé ou bronze avec piètement en métal chromé ou gunmetal, laqué blanc ou noir mat.

	I	dimensioni	spessore	volume	carico ammesso	peso	prezzo
	E	dimension	thickness	volume	admitted load	weight	price
	D	abmessungen	stärke	volumen	tragfähigkeit	gewicht	preis
	F	dimension	épaisseur	volume	charge admise	poids	prix
		cm	mm	m3	kg	kg	euro

Liber E-F design Luca Papini 2013/2019	E	40 x 40 x h 40	10 / 12	0,14	15 *	30	<input type="checkbox"/> 1.020 <input checked="" type="checkbox"/> 1.060 <input type="checkbox"/> 1.090
	F	40 x 60 x h 60	12 / 10	0,18	15 *	38	<input type="checkbox"/> 1.060 <input checked="" type="checkbox"/> 1.110 <input type="checkbox"/> 1.140

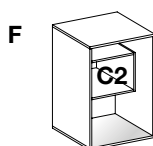

Optional CASSETTO C2 / Optional CASSETTO C2 / Opzional CASSETTO C2 / Optionnel CASSETTO C2

* ogni ripiano / on each shelf / auf jedem Bord / pour chaque étagère

- Vetro extrachiaro / extra clear glass / extrahelles Glas / verre extra clair
- Vetro fumé / smoked glass / Rauchglas / verre fumé
- Vetro bronzo / bronze glass / Bronze Glas / Verre bronze

Ripiano superiore cassetto in vetro acidato / laccato ral / vetro a specchio 80
 Top drawer shelf in frosted glass / ral lacquered glass / mirrored glass
 Glasplatte über Laden in geätzt/ral lackiertem / verspiegeltem Glas
 Étagère supérieur tiroir en verre mordancé / lacqué ral / miroir

- Fianco divano o comodino in vetro con base a specchio e piedini regolabili. Cassetti optional.
- End table or bed side table in glass with mirrored base. Optional drawers.
- Abstelltisch oder Nachttisch aus Glas mit Spiegelboden. Optionale Schubladen.
- Petite table ou chevet en verre avec base en miroir. Tiroirs optionnels.

Liber G design Luca Papini 2015/2019		80 x 40 x h 60	12 / 10	0,18	18 *	68	<input type="checkbox"/> 1.450 <input checked="" type="checkbox"/> 1.500 <input type="checkbox"/> 1.560
--	--	----------------	---------	------	------	----	---

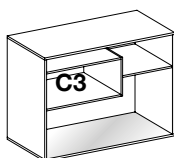

Optional CASSETTO C3 / Optional CASSETTO C3 / Opzional CASSETTO C3 / Optionnel CASSETTO C3

* ogni ripiano / on each shelf / auf jedem Bord / pour chaque étagère

- Vetro extrachiaro / extra clear glass / extrahelles Glas / verre extra clair
- Vetro fumé / smoked glass / Rauchglas / verre fumé
- Vetro bronzo / bronze glass / Bronze Glas / Verre bronze

Ripiano superiore cassetto in vetro acidato / laccato ral / vetro a specchio 100
 Top drawer shelf in frosted glass / ral lacquered glass / mirrored glass
 Glasplatte über Laden in geätzt/ral lackiertem / verspiegeltem Glas
 Étagère supérieur tiroir en verre mordancé / lacqué ral / miroir

- Fianco divano o comodino in vetro con base a specchio e piedini regolabili. Cassetti optional.
- End table or bed side table in glass with mirrored base. Optional drawers.
- Abstelltisch oder Nachttisch aus Glas mit Spiegelboden. Optionale Schubladen.
- Petite table ou chevet en verre avec base en miroir. Tiroirs optionnels.

	I E D F	dimensioni dimension abmessungen dimension	spessore thickness stärke épaisseur	volume volume volumen volume	carico ammesso admitted load tragfähigkeit charge admise	peso weight gewicht poids	prezzo price preis prix
		cm	mm	m3	kg	kg	euro
Liber cassetto design Luca Papini 2013/2022	C1	19 x 40 x h 25		0,03	15	2,5	● 290 ●● 300 ●●● 340 ●●●● 460
	C2	25 x 40 x h 19		0,03	15	2,5	● 290 ●● 300 ●●● 340 ●●●● 460
	C3	45 x 40 x h 19		0,06	15	4,5	● 330 ●● 340 ●●● 360 ●●●● 490

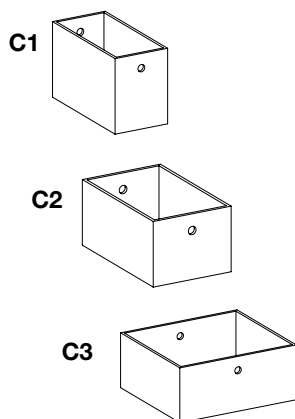

- Cassetto in legno laccato in finitura bianco opaco con foro bifacciale.
- Drawer in matt white lacquered wood with double sided opening.
- Schublade aus Holz matt weiß lackiert mit beidseitiger Öffnung.
- Tiroir en bois laqué mat blanc avec trou biface.

- Cassetto in legno laccato in finitura RAL opaco con foro bifacciale
- Drawer in matt RAL lacquered wood with double sided opening.
- Schublade aus Holz matt RAL lackiert mit beidseitiger Öffnung.
- Tiroir en bois laqué mat RAL avec trou biface.

- Cassetto in legno SIBERIAN ASH, EUCALIPTO e Noce Canaletto con maniglia in pelle.
- Wooden drawer in SIBERIAN ASH, EUCALIPTO and Canaletto Walnut with leather knob.
- Holzschublade aus SIBERIAN ASH, EUCALIPTO und Canaletto Walnuß mit Ledergriff.
- Tiroir en bois SIBERIAN ASH, EUCALIPTO et Noyer Canaletto avec pommeau en cuir.

- Cassetto in cuoio testa di moro con una maniglia.
- Drawer in dark leather with one handle.
- Schublade aus dunklem Leder mit einem Griff.
- Tiroir en cuir Tête-De-Maure avec un pommeau.

	I E D F	dimensioni dimension abmessungen dimension	spessore thickness stärke épaisseur	volume volume volumen volume	carico ammesso admitted load tragfähigkeit charge admise	peso weight gewicht poids	prezzo price preis prix
		cm	mm	m3	kg	kg	euro

Metropolis

design G. Maurizio Scutellà 2017



50 x 50 x h 55	12	0,25	50	32	<input type="checkbox"/> 860 <input checked="" type="checkbox"/> 890 <input checked="" type="checkbox"/> 900
Ø 60 x h 55	10 / 12	0,34	50	34	<input type="checkbox"/> 890 <input checked="" type="checkbox"/> 920 <input checked="" type="checkbox"/> 930

- basamento e piano vetro extrachiaro / extra clear glass base and top
Gestell und Tischplatte extrahell Glas / piètement et top verre extra clair
- basamento e piano vetro fumè / smoked glass base and top
Gestell und Tischplatte aus Rauchglas / piètement et top verre fumé
- basamento e piano vetro bronzo / bronze glass base and top
Gestell und Tischplatte aus Bronze Glas / piètement et top verre bronze

- Fianco divano o comodino con basamento in vetro extrachiaro, fumè o bronzo.
Top in vetro extrachiaro, fumè o bronzo.
- Side table or bedside with base in extra clear, smoked or bronze glass.
Top in extra clear, smoked or bronze glass.
- Beistelltisch oder Nachttisch mit Gestell in extrahellem Glas, Rauchglas oder Bronze.
Topplatte aus extrahellem Glas, Rauchglas oder Bronze.
- Table de chevet ou table de nuit avec piètement en verre extra clair, fumé ou bronze.
Top en verre extra clair ou fumé.

Metropolis ceramic

design G. Maurizio Scutellà 2017



60 x 60 x h 55	12 / 8 + 5	0,34	50	37	<input type="checkbox"/> 1.210 <input checked="" type="checkbox"/> 1.240 <input checked="" type="checkbox"/> 1.250
Ø 75 x h 55	12 / 8 + 5	0,50	50	45	<input type="checkbox"/> 1.370 <input checked="" type="checkbox"/> 1.400 <input checked="" type="checkbox"/> 1.410

- basamento in vetro extrachiaro / base in extra clear glass
Gestell aus extrahellem Glas / piètement en verre extra clair
- basamento in vetro fumè / base in smoked glass
Gestell aus Rauchglas / piètement en verre fumé
- basamento in vetro bronzo / base in bronze glass
Gestell aus Bronze Glas / piètement en verre bronze

- Fianco divano o comodino con basamento in vetro extrachiaro, fumè o bronzo. Top in ceramica+vetro nelle seguenti finiture:
Pietra di Savoia antracite bocciardato, Noir desir lucido o opaco, Calacatta oro venato lucido, Pietra Grey opaco, Sahara noir lucido o bocciardato e Travertino.
- Side table or bedside with base in extra clear, smoked or bronze glass. Top made of ceramic+glass with following finishes:
Pietra di Savoia anthracite bushhammered, Noir desir polished or matt, Calacatta oro venato polished, Pietra Grey matt, Sahara noir polished or bushhammered and Travertino.
- Beistelltisch oder Nachttisch mit Gestell in extrahellem Glas, Rauchglas oder Bronze. Top aus Keramik+Glas in folgenden Ausfertigungen: **Pietra di Savoia Anthrazit bocciardato, Noir desir glänzend oder matt, Calacatta oro venato glänzend, Pietra Grey matt, Sahara noir glänzend oder bocciardato und Travertino.**
- Table de chevet ou table de nuit avec piètement en verre extra clair, fumé ou bronze. Top en céramique+verre dans les suivants finitions: **Pietra di Savoia anthracite bouchardé, Noir desir brillant ou mat, calacatta oro venato brillant, Pietra Grey mat, Sahar noir brillant ou bouchardé et Travertino.**

	I	dimensioni	spessore	volume	carico ammesso	peso	prezzo
	E	dimension	thickness	volume	admitted load	weight	price
	D	abmessungen	stärke	volumen	tragfähigkeit	gewicht	preis
	F	dimension	épaisseur	volume	charge admise	poids	prix
		cm	mm	m3	kg	kg	euro

Oasis

Ø45 x h45

0,14

15

12

1.180

design Massimo Castagna 2025

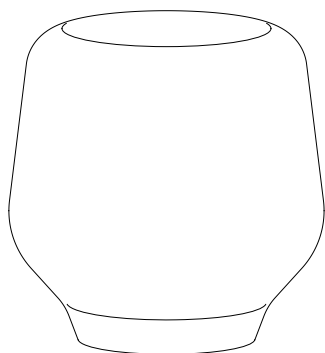

Ø60 x h32

0,21

15

14

1.480

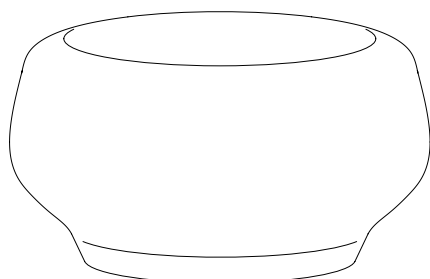

**Specificare sempre la finitura del vetro Ambra scuro, Bronzo, Fumè o Verde Pavone.
Always specify glass finish, dark amber, bronze, smoked or peafowl green
Immer Glasausführung angeben dunkles Amber, bronze, rauchfarbe oder Pfauengrün
Toujours spécifier finition du verre ambre foncé, bronze, fumé ou vert paon**

- Tavolino basso o fianco divano in vetro soffiato di Murano, disponibili in diversi colori.
Ogni pezzo viene soffiato, secondo la tradizionale tecnica, da artigiani del vetro di Murano.
Eventuali imperfezioni dovute alla soffiatura del vetro sono da ritenersi caratteristiche del prodotto e dettagli di qualità e originalità.
- Cocktail table or side table in Murano blown glass, available in several colours.
Each piece is blown, according to the traditional technique, by Murano glass artisans.
Any imperfections due to glass blowing are to be considered characteristics of the product and details of quality and originality.
- Couchtisch oder Beistelltisch aus geblasenem Murano Glas, erhältlich in verschiedenen Farben.
Jedes Stück wird von Murano-Glashandwerkern nach traditioneller Technik geblasen.
Eventuelle Unvollkommenheiten, die durch die Glasbläserei entstehen, sind als Eigenschaften des Produktes und als Angaben zur Qualität und Originalität anzusehen.
- Table bas ou table de chevet en verre soufflé de Murano, disponible en différents couleurs.
Chaque pièce est soufflée, selon la technique traditionnelle, par des artisans verriers de Murano.
Les éventuelles imperfections dues au soufflage du verre doivent être considérées comme des caractéristiques du produit et des détails de qualité et d'originalité.

	I	dimensioni	spessore	volume	carico ammesso	peso	prezzo
	E	dimension	thickness	volume	admitted load	weight	price
	D	abmessungen	stärke	volumen	tragfähigkeit	gewicht	preis
	F	dimension	épaisseur	volume	charge admise	poids	prix
		cm	mm	m3	kg	kg	euro

Opalina sgabello

design Cristina Celestino 2016

Ø 38 x h 45

12

0,138

80

18

630

660

680

Cuscino in pelle / Cushion in leather / Kissen aus Leder / Coussin en cuir

380

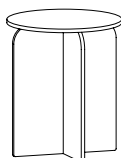

- Vetro extrachiaro / extra clear glass / extrahelles Glas / verre extra clair
- Vetro fumé / smoked glass / Rauchglas / verre fumé
- Vetro bronzo / bronze glass / Glas Bronze / verre bronze

- Sgabello o fianco divano in vetro extra chiaro, fumé o bronzo. Optional cuscino in pelle.
 - Stool or side table in extra clear, smoked or bronze glass. Optional cushion in leather.
 - Hocker oder Beistelltisch in extrahellem, Rauchglas oder Bronze Glas. Optionaler Kissen aus Leder.
 - Tabouret ou table de chevet en verre extra clair, fumé ou bronze. Optionnel coussin en cuir.

Sestante

design Emilio Nanni 2023

Ø 50 x h 42

10

0,2

20

24

630

660

730

Ø 50 x h 54

10

0,22

20

29

690

720

790

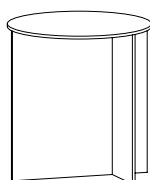

- basamento e piano extrachiaro / extra clear base and top
Gestell und Tischplatte extrahell / piètement et top extra clair
- basamento e piano fumé / smoked base and top
Gestell und Tischplatte aus Rauchglas / piètement et top fumé
- basamento e piano bronzo / bronze base and top
Gestell und Tischplatte aus Bronze Glas / piètement et top bronze

- Tavolo basso o fianco divano in vetro extrachiaro, fumé o bronzo.
 - Low table or side table in extra clear, smoked or bronze glass.
 - Couchtisch oder Beistelltisch aus extrahellem Glas, Rauchglas oder Bronze Glas.
 - Table bas ou table de chevet verre en extra clair, fumé ou bronze.

	I	dimensioni	spessore	volume	carico ammesso	peso	prezzo
	E	dimension	thickness	volume	admitted load	weight	price
	D	abmessungen	stärke	volumen	tragfähigkeit	gewicht	preis
	F	dimension	épaisseur	volume	charge admise	poids	prix
		cm	mm	m3	kg	kg	euro

Soft glass side

35 x 98 x h 36

design Massimo Castagna 2024

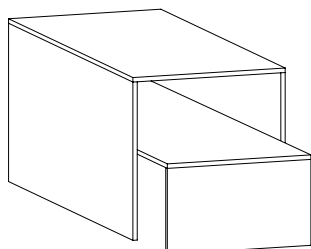

- 780
- 800
- 810

- Vetro extrachiaro / extra clear glass / extrahelles Glas / verre extra clair
- Vetro fumé / smoked glass / Rauchglas / verre fumé
- Vetro bronzo / bronze glass / Bronze Glas / Verre bronze

- Fianco divano in vetro saldato nelle finiture extrachiaro, fumé o bronzo.
- Side table in welded glass in finishes extra clear, smoked or bronze.
- Beistelltisch aus geschweißtem Glas in Ausführung extrahell, Rauchfarbe oder Bronze.
- Table de chevet en verre soudé en finitions extra clair, fumé ou bronze.

Trio

design M. U.

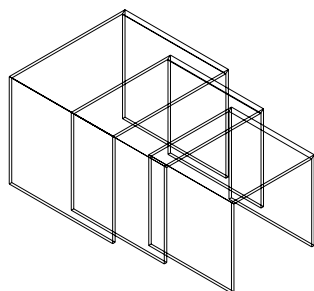

40 x 40 x h 38	10	0,146	40	20	<input type="checkbox"/> 510
					<input checked="" type="checkbox"/> 540
					<input checked="" type="checkbox"/> 550
48 x 45 x h 41	10	0,193	40	24	<input type="checkbox"/> 540
					<input checked="" type="checkbox"/> 570
					<input checked="" type="checkbox"/> 580
56 x 50 x h 45	10	0,257	40	30	<input type="checkbox"/> 590
					<input checked="" type="checkbox"/> 630
					<input checked="" type="checkbox"/> 640

- Tris completo, come da disegno
 - Complete nest of table as drawing
 - Kompletter Dreisatz-Tisch wie Abbildung
 - Set de tables cicognes comme dessin
- 1.640
 - 1.740
 - 1.770

- Vetro extrachiaro / extra clear glass / extrahelles Glas / verre extra clair
- Vetro fumé / smoked glass / Rauchglas / verre fumé
- Vetro bronzo / bronze glass / Glas Bronze / verre bronze

- Serie di tavolini impilabili. **Disponibili con dimensioni a richiesta.**
- Stacking tables. **Special sizes available.**
- Dreisatztisch. **Sonderanfertigungen sind möglich.**
- Petites tables superposables. **Dimensions spéciales sur demande.**

specchi | mirrors

	I	dimensioni	spessore	volume	carico ammesso	peso	prezzo
	E	dimension	thickness	volume	admitted load	weight	price
	D	abmessungen	stärke	volumen	tragfähigkeit	gewicht	preis
	F	dimension	épaisseur	volume	charge admise	poids	prix
		cm	mm	m3	kg	kg	euro
Bands	A	100 x 4 x h 100	8	0,16		47	● 1.780
angeletti ruzza design 2019							●● 1.830
							●●● 1.840

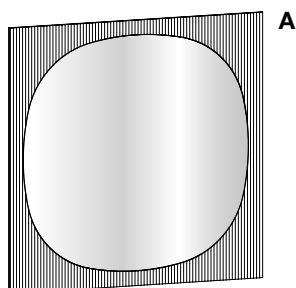

- Specchio / Mirror / Spiegel / Miroir
- Specchio fumè / Smoked mirror / Rauchglasspiegel / miroir fumé
- Specchio bronzo / Bronze mirror / Bronze Spiegel / Miroir bronze

-
- Specchio da parete con cornice realizzata dall'unione di uno specchio e di un vetro cannettato. Disponibile in specchio, specchio fumè e bronzo. La cornice è sempre della stessa finitura dello specchio centrale.
 - Wall mirror with frame created by joining a mirror with a reeds-like effect glass. Available in mirror, smoked mirror and bronze. The frame always has the same finish of the central mirror
 - Wandspiegel mit Rahmen, der aus der Vereinigung von einem Spiegel und einem Schilffartigem Glas verwirklicht ist. Verfügbar in Spiegel, Rauchglasspiegel und Bronze. Der Rahmen hat immer die Ausführung des zentralen Spiegel.
 - Miroir au mur avec corniche réalisé par l'union d'un miroir et d'une verre à effet cannaie. Disponible en miroir, miroir fumé ou bronze. La corniche a toujours la même finition du miroir.

	I	dimensioni	spessore	volume	carico ammesso	peso	prezzo
	E	dimension	thickness	volume	admitted load	weight	price
	D	abmessungen	stärke	volumen	tragfähigkeit	gewicht	preis
	F	dimension	épaisseur	volume	charge admise	poids	prix
		cm	mm	m3	kg	kg	euro

Bands angeletti ruzza design 2019	B	90 x 4 x h180	8	0,25		62	● 2.420
							●● 2.530
							●●● 2.540

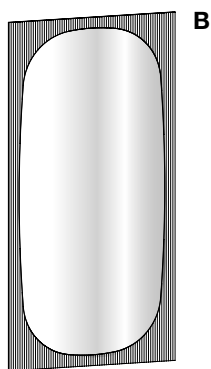

	C	110 x 4 x h200	8	0,33		98	● 2.820
							●● 2.950
							●●● 2.960

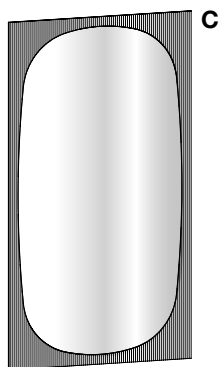

- Specchio / Mirror / Spiegel / Miroir
- Specchio fumè / Smoked mirror / Rauchglasspiegel / miroir fumé
- Specchio bronzo / Bronze mirror / Bronze Spiegel / Miroir bronze

- Specchio da parete con cornice realizzata dall'unione di uno specchio e di un vetro cannettato. Disponibile in specchio, specchio fumè e bronzo. La cornice è sempre della stessa finitura dello specchio centrale.
- Wall mirror with frame created by joining a mirror with a reeds-like effect glass. Available in mirror, smoked mirror and bronze. The frame always has the same finish of the central mirror
- Wandspiegel mit Rahmen, der aus der Vereinigung von einem Spiegel und einem Schilffartigem Glas verwirklicht ist. Verfügbar in Spiegel, Rauchglasspiegel und Bronze. Der Rahmen hat immer die Ausführung des zentralen Spiegel.
- Miroir au mur avec corniche réalisé par l'union d'un miroir et d'une verre à effet cannaie. Disponible en miroir, miroir fumé ou bronze. La corniche a toujours la même finition du miroir.

	I	dimensioni	spessore	volume	carico ammesso	peso	prezzo
	E	dimension	thickness	volume	admitted load	weight	price
	D	abmessungen	stärke	volumen	tragfähigkeit	gewicht	preis
	F	dimension	épaisseur	volume	charge admise	poids	prix
		cm	mm	m3	kg	kg	euro

Barcode

A 100 x 3 x h 200	8	0,25		67	2.280
--------------------------	---	------	--	----	--------------

design G. Maurizio Scutellà 2019

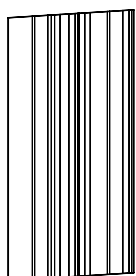

A

B 90 x 3 x h 90	8	0,11		35	1.140
------------------------	---	------	--	----	--------------

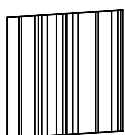

B

C Ø 200 x 3	8	0,50		114	* 4.560
--------------------	---	------	--	-----	----------------

- * lo specchio è realizzato da due elementi accostati (D+D)
- * mirror made by combining two elements (D+D)
- * Spiegel ergibt sich aus zwei Elementen nebeneinander (D+D)
- * miroir réalisé par deux éléments approchés (D+D)

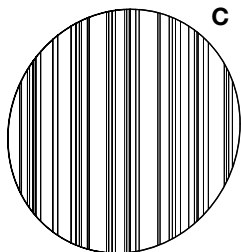

C

D 100 x 3 x h 200	8	0,25		57	* 2.280
--------------------------	---	------	--	----	----------------

- * Semicerchio / semicircle / Halbkreis / demi-cercle

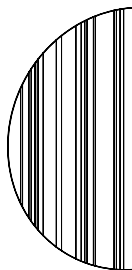

D

E Ø 120 x 3	8	0,19		48	1.770
--------------------	---	------	--	----	--------------

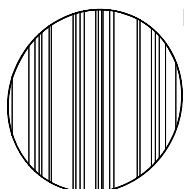

E

F Ø 90 x 3	8	0,09		33	* 1.380
-------------------	---	------	--	----	----------------

- * lo specchio è realizzato da due elementi accostati (G+G)
- * mirror made by combining two elements (G+G)
- * Spiegel ergibt sich aus zwei Elementen nebeneinander (G+G)
- * miroir réalisé par deux éléments approchés (G+G)

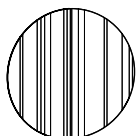

F

G 45 x 3 x h 90	8	0,05		24	* 690
------------------------	---	------	--	----	--------------

- * Semicerchio / semicircle / Halbkreis / demi-cercle

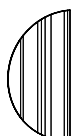

G

- Specchio da parete formato da un vetro dove si alternano fasce specchiate a fasce trasparenti. Le fasce trasparenti permettono di vedere la parete retrostante.
- Wall mirror made of a glass panel with alternating mirrored and transparent bands. The transparent bands allow to see the wall behind.
- Wandspiegel aus einem Glaspanel mit abwechselnden transparenten und verspiegelten Streifen. Die Rückwand ist durch die transparenten Streifen sichtbar.
- Miroir au mur réalisé avec une verre où il y a une alternance de bandes en miroir et transparent. Les bandes transparents permettent de voir le mur à l'arrière.

Barcode

design G. Maurizio Scutellà 2019

Composizioni / compositions / Kompositionen / compositions

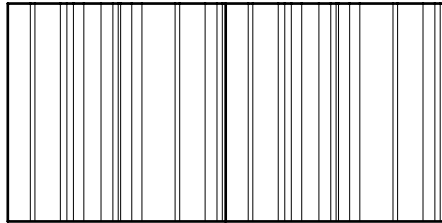

Comp. 1 - 180 x 3 x h 90 (B+B)
2.280

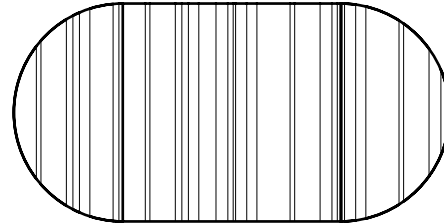

Comp. 2 - 180 x 3 x h 90 (G+B+G)
2.520

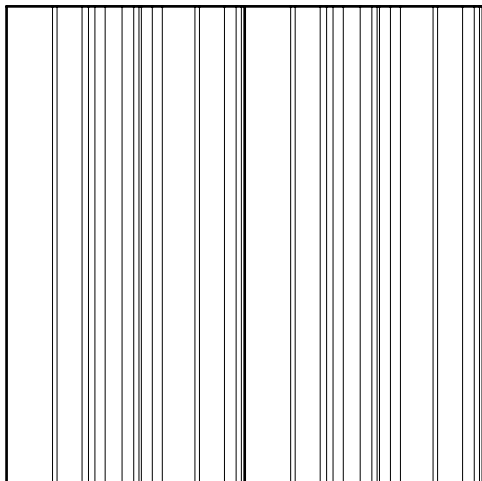

Comp. 3 - 200 x 3 x h 200 (A+A)
4.560

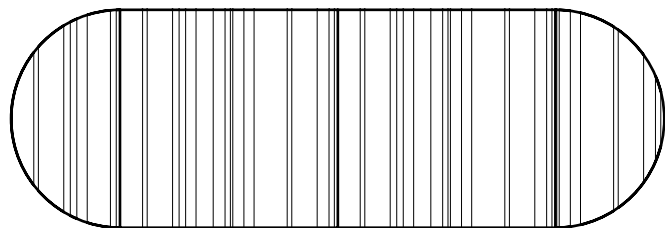

Comp. 4 - 270 x 3 x h 90 (G+B+B+G)
3.660

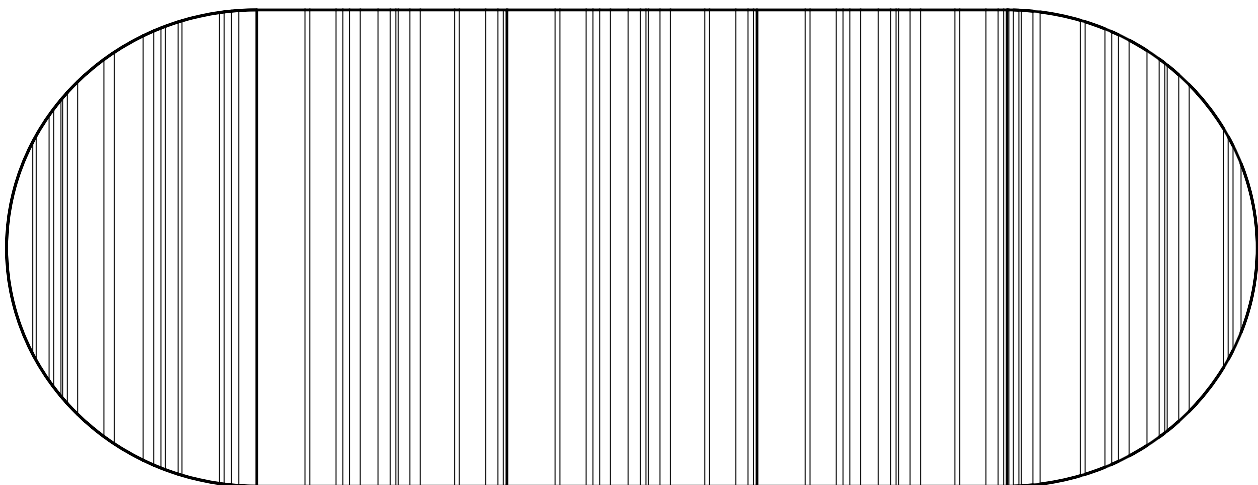

Comp. 5 - 500 x 3 x h 200 (D+A+A+A+D)
11.400

-
- Esempi di composizioni che si possono ottenere accostando tra di loro gli elementi di pagina 138.
 - Examples of compositions given by joining elements of page 138.
 - Kompositionsbeispiele der Elemente auf Seite 138.
 - Exemples de compositions que on peut obtenir en rapprochant les éléments de page 138.

	I E D F	dimensioni dimension abmessungen dimension	spessore thickness stärke épaisseur	volume volume volumen volume	carico ammesso admitted load tragfähigkeit charge admise	peso weight gewicht poids	prezzo price preis prix
		cm	mm	m3	kg	kg	euro

Beryl design F. Forcellini 2023	118 x h 120	4	0,34		60	● 1.970 ●● 2.060 ●●● 2.100
---	-------------	---	------	--	----	----------------------------------

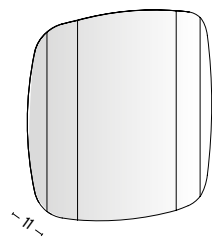

- Specchio / Mirror / Spiegel / Miroir
- Specchio fumè / Smoked mirror / Rauchglasspiegel / miroir fumé
- Specchio bronzo / Bronze mirror / Bronze Spiegel / Miroir bronze

Specchio da parete verticale o orizzontale, con struttura in legno verniciata nero. Gli specchi laterali sono inclinati.
Wall mirror vertical or horizontal with black lacquered wooden structure. The side mirrors are inclined.
Wandspiegel senkrecht oder waagrecht mit schwarz lackierter Struktur. Die Seitenspiegel sind schräg.
Miroir au mur vertical ou horizontal avec structure en bois laqué noir. Les miroirs latéraux sont inclinés.

Beryl design F. Forcellini 2023	157 x h 160	4	0,63		98	● 2.780 ●● 2.910 ●●● 2.960
---	-------------	---	------	--	----	----------------------------------

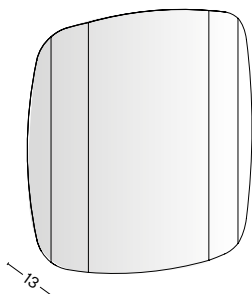

- Specchio / Mirror / Spiegel / Miroir
- Specchio fumè / Smoked mirror / Rauchglasspiegel / miroir fumé
- Specchio bronzo / Bronze mirror / Bronze Spiegel / Miroir bronze

Specchio da parete verticale o orizzontale, con struttura in legno verniciata nero. Gli specchi laterali sono inclinati.
Wall mirror vertical or horizontal with black lacquered wooden structure. The side mirrors are inclined.
Wandspiegel senkrecht oder waagrecht mit schwarz lackierter Struktur. Die Seitenspiegel sind schräg.
Miroir au mur vertical ou horizontal avec structure en bois laqué noir. Les miroirs latéraux sont inclinés.

Beryl design F. Forcellini 2023	196 x h 200	4	1,06		137	● 3.770 ●● 3.920 ●●● 3.980
---	-------------	---	------	--	-----	----------------------------------

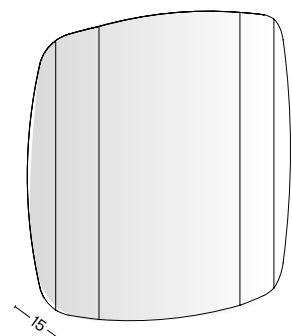

- Specchio / Mirror / Spiegel / Miroir
- Specchio fumè / Smoked mirror / Rauchglasspiegel / miroir fumé
- Specchio bronzo / Bronze mirror / Bronze Spiegel / Miroir bronze

Specchio da parete verticale o orizzontale, con struttura in legno verniciata nero. Gli specchi laterali sono inclinati.
Wall mirror vertical or horizontal with black lacquered wooden structure. The side mirrors are inclined.
Wandspiegel senkrecht oder waagrecht mit schwarz lackierter Struktur. Die Seitenspiegel sind schräg.
Miroir au mur vertical ou horizontal avec structure en bois laqué noir. Les miroirs latéraux sont inclinés.

	I	dimensioni	spessore	volume	carico ammesso	peso	prezzo
	E	dimension	thickness	volume	admitted load	weight	price
	D	abmessungen	stärke	volumen	tragfähigkeit	gewicht	preis
	F	dimension	épaisseur	volume	charge admise	poids	prix
		cm	mm	m3	kg	kg	euro

Beryl design F. Forcellini 2023	196 x h 130	4	0,68			104	● 2.860
							●● 2.940
							●●● 2.990

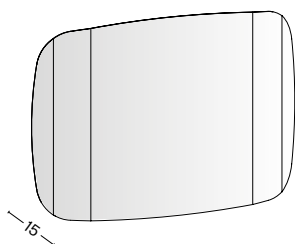

- Specchio / Mirror / Spiegel / Miroir
- Specchio fumè / Smoked mirror / Rauchglasspiegel / miroir fumé
- Specchio bronzo / Bronze mirror / Bronze Spiegel / Miroir bronze

Specchio da parete verticale o orizzontale, con struttura in legno verniciata nero. Gli specchi laterali sono inclinati.
 Wall mirror vertical or horizontal with black lacquered wooden structure. The side mirrors are inclined.
 Wandspiegel senkrecht oder waagrecht mit schwarz lackierter Struktur. Die Seitenspiegel sind schräg.
 Miroir au mur vertical ou horizontal avec structure en bois laqué noir. Les miroirs latéraux sont inclinés.

Beryl design F. Forcellini 2023	118 x h 200	4	0,55			92	● 2.740
							●● 2.880
							●●● 2.930

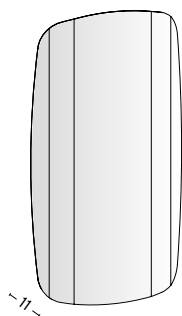

- Specchio / Mirror / Spiegel / Miroir
- Specchio fumè / Smoked mirror / Rauchglasspiegel / miroir fumé
- Specchio bronzo / Bronze mirror / Bronze Spiegel / Miroir bronze

Specchio da parete verticale o orizzontale, con struttura in legno verniciata nero. Gli specchi laterali sono inclinati.
 Wall mirror vertical or horizontal with black lacquered wooden structure. The side mirrors are inclined.
 Wandspiegel senkrecht oder waagrecht mit schwarz lackierter Struktur. Die Seitenspiegel sind schräg.
 Miroir au mur vertical ou horizontal avec structure en bois laqué noir. Les miroirs latéraux sont inclinés.

	I E D F	dimensioni dimension abmessungen dimension	spessore thickness stärke épaisseur	volume volume volumen volume	carico ammesso admitted load tragfähigkeit charge admise	peso weight gewicht poids	prezzo price preis prix
		cm	mm	m3	kg	kg	euro

Central 160

design F. Forcellini 2020

160 x 16 x h 160	4	1,08		105	● 3.230
					●● 3.400
					●●● 3.420

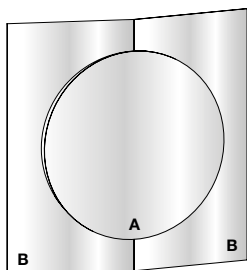

- Specchio / Mirror / Spiegel / Miroir
- Specchio fumè / Smoked mirror / Rauchglasspiegel / miroir fumé
- Specchio bronzo / Bronze mirror / Bronze Spiegel / Miroir bronze

B - Pannelli Esterni / external panels / Äußere Platten / Panneaux extérieurs			
	Specchio Mirror Spiegel Miroir	Specchio fumè Smoked mirror Rauchglasspiegel miroir fumé	Specchio bronzo Bronze mirror Bronze Spiegel Miroir bronze
A - Pannello Centrale Central panel / Zentrale Platte Panneau Central			
160 x 160			
Specchio / Mirror / Spiegel / Miroir	3.230	3.340	3.350
Specchio fumè / Smoked mirror Rauchglasspiegel / miroir fumé	3.290	3.400	3.410
Specchio bronzo / Bronze mirror Bronze Spiegel / Miroir bronze	3.300	3.410	3.420

Central 200

design F. Forcellini 2019

200 x 18 x h 200	4	1,35		131	● 4.150
					●● 4.420
					●●● 4.440

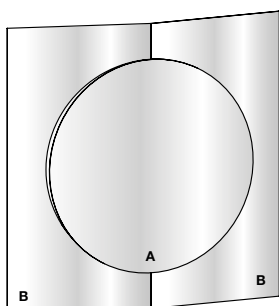

- Specchio / Mirror / Spiegel / Miroir
- Specchio fumè / Smoked mirror / Rauchglasspiegel / miroir fumé
- Specchio bronzo / Bronze mirror / Bronze Spiegel / Miroir bronze

B - Pannelli Esterni / external panels / Äußere Platten / Panneaux extérieurs			
	Specchio Mirror Spiegel Miroir	Specchio fumè Smoked mirror Rauchglasspiegel miroir fumé	Specchio bronzo Bronze mirror Bronze Spiegel Miroir bronze
A - Pannello Centrale Central panel / Zentrale Platte Panneau Central			
200 x 200			
Specchio / Mirror / Spiegel / Miroir	4.150	4.320	4.330
Specchio fumè / Smoked mirror Rauchglasspiegel / miroir fumé	4.250	4.420	4.430
Specchio bronzo / Bronze mirror Bronze Spiegel / Miroir bronze	4.260	4.430	4.440

Specificare sempre la finitura degli specchi esterni (B) e dello specchio centrale (A)
Always specify finish of exterior mirrors (B) and central mirror (A)
Immer Ausführung der externen Spiegel (B) und des zentralen Spiegel angeben (A)
Spécifier toujours finition des miroirs extérieurs (B) et du miroir central (A)

- Specchio da parete formato da due pannelli esterni leggermente inclinati e da uno rotondo centrale. Disponibile in specchio, specchio fumè e bronzo. Si possono avere i pannelli con due finiture di specchio differenti. La struttura è sempre nera.
- Wall mirror made of two slightly tilted external panels and a round central panel. Panels can be of two different finishes. Available in mirror, smoked and bronze mirror. Black supporting frame.
- Wandspiegel aus zwei äußeren leicht schrägen Platten und einer runden zentralen Platte. Verfügbar in Spiegel, Rauchglasspiegel und Bronze Spiegel.
- Die Platten können aus zwei verschiedenen Ausfertigungen sein. Struktur immer schwarz.
- Miroir au mur composé de deux panneaux extérieurs légèrement inclinés et un ronde central. Disponible en miroir, miroir fumé et bronze. Panneaux peuvent être en deux finitions différents. Structure toujours noir.

	I E D F	dimensioni dimension abmessungen dimension	spessore thickness stärke épaisseur	volume volume volumen volume	carico ammesso admitted load tragfähigkeit charge admise	peso weight gewicht poids	prezzo price preis prix
		cm	mm	m3	kg	kg	euro

Central Round 160

Ø160 x16

4

0,60

118

● 3.870
●● 4.020
●●● 4.040

design F. Forcellini 2025

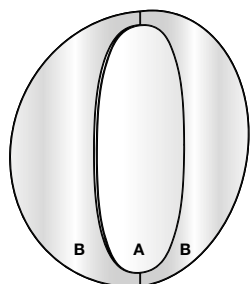

- Specchio / Mirror / Spiegel / Miroir
- Specchio fumè / Smoked mirror / Rauchglasspiegel / miroir fumé
- Specchio bronzo / Bronze mirror / Bronze Spiegel / Miroir bronze

	B - Pannelli Esterni / external panels / Äußere Platten / Panneaux extérieurs		
	Specchio Mirror Spiegel Miroir	Specchio fumè Smoked mirror Rauchglasspiegel miroir fumé	Specchio bronzo Bronze mirror Bronze Spiegel Miroir bronze
A - Pannello Centrale Central panel / Zentrale Platte Panneau Central	Ø 160		
Specchio / Mirror / Spiegel / Miroir	3.870	3.980	3.990
Specchio fumè / Smoked mirror Rauchglasspiegel / miroir fumé	3.910	4.020	4.030
Specchio bronzo / Bronze mirror Bronze Spiegel / Miroir bronze	3.920	4.030	4.040

Central Round 200

Ø200 x16

4

1,04

148

● 4.790
●● 5.050
●●● 5.070

design F. Forcellini 2025

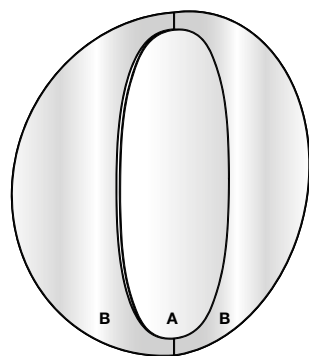

- Specchio / Mirror / Spiegel / Miroir
- Specchio fumè / Smoked mirror / Rauchglasspiegel / miroir fumé
- Specchio bronzo / Bronze mirror / Bronze Spiegel / Miroir bronze

	B - Pannelli Esterni / external panels / Äußere Platten / Panneaux extérieurs		
	Specchio Mirror Spiegel Miroir	Specchio fumè Smoked mirror Rauchglasspiegel miroir fumé	Specchio bronzo Bronze mirror Bronze Spiegel Miroir bronze
A - Pannello Centrale Central panel / Zentrale Platte Panneau Central	Ø 200		
Specchio / Mirror / Spiegel / Miroir	4.790	4.980	4.990
Specchio fumè / Smoked mirror Rauchglasspiegel / miroir fumé	4.860	5.050	5.060
Specchio bronzo / Bronze mirror Bronze Spiegel / Miroir bronze	4.870	5.060	5.070

Specificare sempre la finitura degli specchi esterni (B) e dello specchio centrale (A)
Always specify finish of exterior mirrors (B) and central mirror (A)
Immer Ausführung der externen Spiegel (B) und des zentralen Spiegel angeben (A)
Spécifier toujours finition des miroirs extérieurs (B) et du miroir central (A)

- Specchio da parete formato da due pannelli esterni leggermente inclinati e da un ovale centrale. Disponibile in specchio, specchio fumè e bronzo. Si possono avere i pannelli con due finiture di specchio differenti. La struttura è sempre nera.
- Wall mirror made of two slightly tilted external panels and an oval central panel. Panels can be of two different finishes. Available in mirror, smoked and bronze mirror. Black supporting frame.
- Wandspiegel aus zwei äußeren leicht schrägen Platten und einer oval zentralen Platte. Verfügbar in Spiegel, Rauchglasspiegel und Bronze Spiegel. Die Platten können aus zwei verschieden Ausfertigungen sein. Struktur immer schwarz.
- Miroir au mur composé de deux panneaux extérieurs légèrement inclinés et un ovale central. Disponible en miroir, miroir fumé et bronze. Panneaux peuvent être en deux finitions différents. Structure toujours noir.

	I	dimensioni	spessore	volume	carico ammesso	peso	prezzo
	E	dimension	thickness	volume	admitted load	weight	price
	D	abmessungen	stärke	volumen	tragfähigkeit	gewicht	preis
	F	dimension	épaisseur	volume	charge admise	poids	prix
		cm	mm	m3	kg	kg	euro

Fittipaldi 90

design G.T. Garattoni 2009

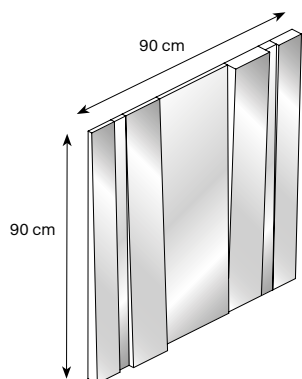

90x6xh.90

4

0,1

29

A 90x5x4

B 90x10x4,5

C 90x15x5,6

D 90x30x2,5

●	880
●●	920
●●●	960
●	90
●●	95
●●●	100
●	110
●●	115
●●●	120
●	130
●●	135
●●●	140
●	220
●●	230
●●●	240

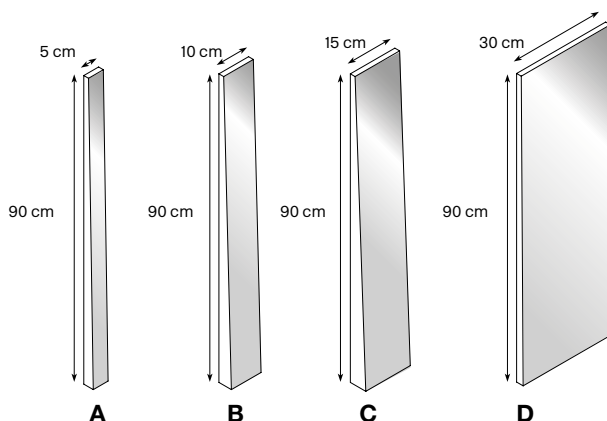

- Specchio / Mirror / Spiegel / Miroir
- Specchio fumè / Smoked mirror / Rauchglasspiegel / miroir fumé
- Specchio bronzo / Bronze mirror / Bronze Spiegel / Miroir bronze

- Specchio a parete con struttura in metallo verniciato nero opaco. Anche componibile. Disponibile in specchio, specchio fumè o bronzo.
- Wall mirror with matt black lacquered metal structure. Also modular. Available in mirror, smoked mirror or bronze mirror.
- Wandspiegel mit Struktur aus matt schwarz lackiertem Metall. Auch modular. Verfügbar in Spiegel, Rauchglas Spiegel oder Bronze Spiegel.
- Miroir à mur avec structure en métal laqué noir mat. Aussi composable. Disponible en miroir, miroir fumé ou bronze.

	I	dimensioni	spessore	volume	carico ammesso	peso	prezzo
	E	dimension	thickness	volume	admitted load	weight	price
	D	abmessungen	stärke	volumen	tragfähigkeit	gewicht	preis
	F	dimension	épaisseur	volume	charge admise	poids	prix
		cm	mm	m3	kg	kg	euro

Fittipaldi 180

design G.T. Garattoni 2009

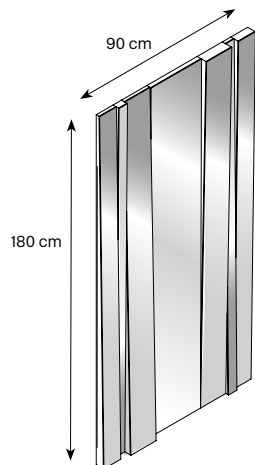

90 x 6 x h 180

4

0,2

50

A 180 x 5 x 4

B 180 x 10 x 4,5

C 180 x 15 x 5,6

D 180 x 30 x 2,5

● 1.260
●● 1.340
●●● 1.410

● 140
●● 150
●●● 160

● 180
●● 190
●●● 200

● 190
●● 200
●●● 210

● 240
●● 260
●●● 270

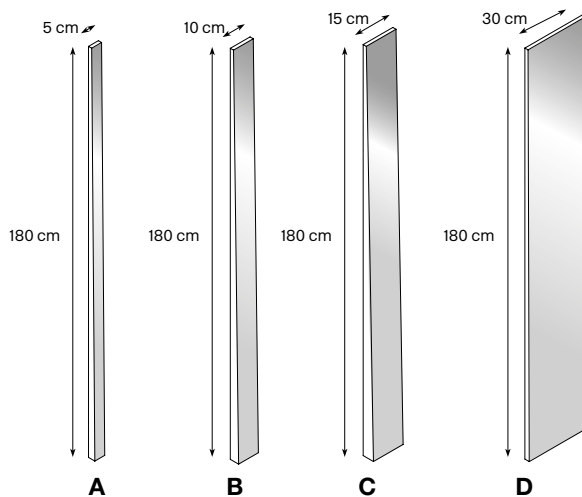

- Specchio / Mirror / Spiegel / Miroir
- Specchio fumè / Smoked mirror / Rauchglasspiegel / miroir fumé
- Specchio bronzo / Bronze mirror / Bronze Spiegel / Miroir bronze

- Specchio a parete con struttura in metallo verniciato nero opaco. Anche componibile.
Disponibile in specchio, specchio fumè o bronzo.

- Wall mirror with matt black lacquered metal structure. Also modular. Available in mirror, smoked mirror or bronze mirror.

- Wandspiegel mit Struktur aus matt schwarz lackiertem Metall. Auch modular.
Verfügbar in Spiegel, Rauchglas Spiegel oder Bronze Spiegel.

- Miroir à mur avec structure en métal laqué noir mat. Aussi composable.
Disponible en miroir, miroir fumé ou bronze.

	I E D F	dimensioni dimension abmessungen dimension	spessore thickness stärke épaisseur	volume volume volumen volume	carico ammesso admitted load tragfähigkeit charge admise	peso weight gewicht poids	prezzo price preis prix
		cm	mm	m3	kg	kg	euro

Gerundio

105 x h 200

4

0,33

70

2.380

2.530

2.540

design G.T. Garattoni 2012

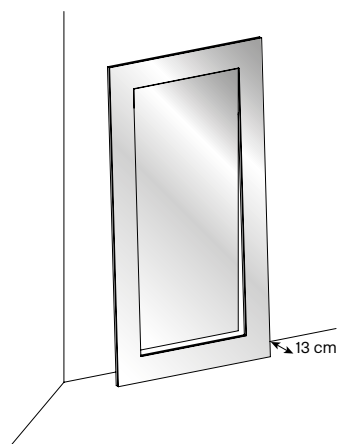

- Specchio / Mirror / Spiegel / Miroir
- Specchio fumè / Smoked mirror / Rauchglasspiegel / miroir fumé
- Specchio bronzo / Bronze mirror / Bronze Spiegel / Miroir bronze

- Specchiera da parete ricavata da un'unica lastra, con cornice inclinata. Struttura in legno verniciata nero.
 - Wall mirror made of an only sheet, with inclined frame. Structure in black lacquered wood.
 - Wandspiegel aus einer einzigen Platte produziert, mit schrägem Rahmen. Struktur aus schwarz lackiertem Holz.
 - Miroir au mur fait d'une sole plaque, avec encadrement incliné. Structure en bois laqué noir.

Gerundio

80 x h 155

4

0,25

46

1.620

1.710

1.720

design G.T. Garattoni 2012

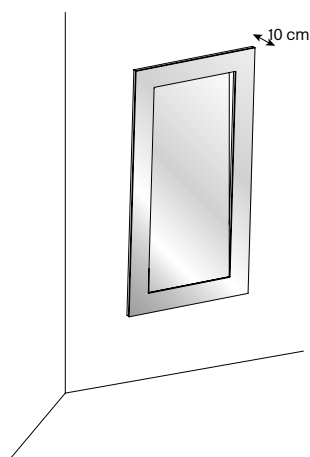

- Specchio / Mirror / Spiegel / Miroir
- Specchio fumè / Smoked mirror / Rauchglasspiegel / miroir fumé
- Specchio bronzo / Bronze mirror / Bronze Spiegel / Miroir bronze

- Specchiera da parete ricavata da un'unica lastra, con cornice inclinata. Struttura in legno verniciata nero.
 - Wall mirror made of an only sheet, with inclined frame. Structure in black lacquered wood.
 - Wandspiegel aus einer einzigen Platte produziert, mit schrägem Rahmen. Struktur aus schwarz lackiertem Holz.
 - Miroir au mur fait d'une sole plaque, avec encadrement incliné. Structure en bois laqué noir.

	I E D F	dimensioni dimension abmessungen dimension	spessore thickness stärke épaisseur	volume volume volumen volume	carico ammesso admitted load tragfähigkeit charge admise	peso weight gewicht poids	prezzo price preis prix
		cm	mm	m3	kg	kg	euro

Gerundio

155 x h 240

8

0,77

171

□ 4.340

design G.T. Garattoni 2023

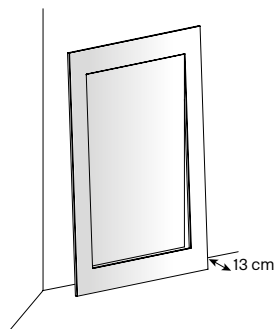

□ Specchio / Mirror / Spiegel / Miroir

- Specchiera da parete ricavata da un'unica lastra, con cornice inclinata. Struttura in legno verniciata nero.
- Wall mirror made of an only sheet, with inclined frame. Structure in black lacquered wood.
- Wandspiegel aus einer einzigen Platte produziert, mit schrägem Rahmen. Struktur aus schwarz lackiertem Holz.
- Miroir au mur fait d'une seule plaque, avec encadrement incliné. Structure en bois laqué noir.

Gerundio

240 x h 196

8

1,01

215

□ 4.870

design G.T. Garattoni 2023

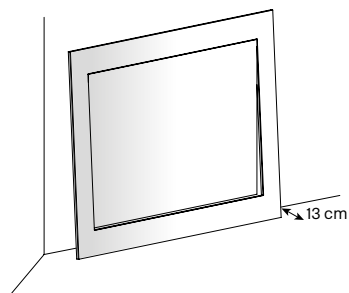

□ Specchio / Mirror / Spiegel / Miroir

- Specchiera da parete ricavata da un'unica lastra, con cornice inclinata. Struttura in legno verniciata nero.
- Wall mirror made of an only sheet, with inclined frame. Structure in black lacquered wood.
- Wandspiegel aus einer einzigen Platte produziert, mit schrägem Rahmen. Struktur aus schwarz lackiertem Holz.
- Miroir au mur fait d'une seule plaque, avec encadrement incliné. Structure en bois laqué noir.

Gerundio

196 x h 196

4

1,81

174

□ 3.880

■ 4.150

■ 4.160

design G.T. Garattoni 2023

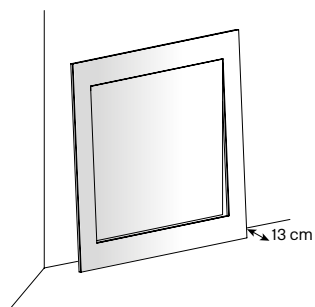

□ Specchio / Mirror / Spiegel / Miroir

- Specchio fumè / Smoked mirror / Rauchglasspiegel / miroir fumé
- Specchio bronzo / Bronze mirror / Bronze Spiegel / Miroir bronze

- Specchiera da parete ricavata da un'unica lastra, con cornice inclinata. Struttura in legno verniciata nero.
- Wall mirror made of an only sheet, with inclined frame. Structure in black lacquered wood.
- Wandspiegel aus einer einzigen Platte produziert, mit schrägem Rahmen. Struktur aus schwarz lackiertem Holz.
- Miroir au mur fait d'une seule plaque, avec encadrement incliné. Structure en bois laqué noir.

	I	dimensioni	spessore	volume	carico ammesso	peso	prezzo
	E	dimension	thickness	volume	admitted load	weight	price
	D	abmessungen	stärke	volumen	tragfähigkeit	gewicht	preis
	F	dimension	épaisseur	volume	charge admise	poids	prix
		cm	mm	m3	kg	kg	euro

Gerundio

105 x h 200

4

0,38

80

2.230

2.370

2.380

design G.T. Garattoni 2015

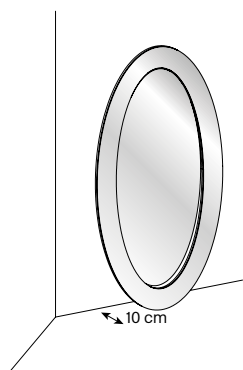

- Specchio / Mirror / Spiegel / Miroir
- Specchio fumè / Smoked mirror / Rauchglasspiegel / miroir fumé
- Specchio bronzo / Bronze mirror / Bronze Spiegel / Miroir bronze

- Specchiera da parete ricavata da un'unica lastra, con cornice inclinata. Struttura in legno verniciata nero.
 - Wall mirror made of an only sheet, with inclined frame. Structure in black lacquered wood.
 - Wandspiegel aus einer einzigen Platte produziert, mit schrägem Rahmen. Struktur aus schwarz lackiertem Holz.
 - Miroir au mur fait d'une sole plaque, avec encadrement incliné. Structure en bois laqué noir.

	I E D F	dimensioni dimension abmessungen dimension	spessore thickness stärke épaisseur	volume volume volumen volume	carico ammesso admitted load tragfähigkeit charge admise	peso weight gewicht poids	prezzo price preis prix
		cm	mm	m3	kg	kg	euro

Gerundio

Ø155

4

0,52

85

□ 2.650

■ 2.830

■ 2.840

design G.T. Garattoni 2015

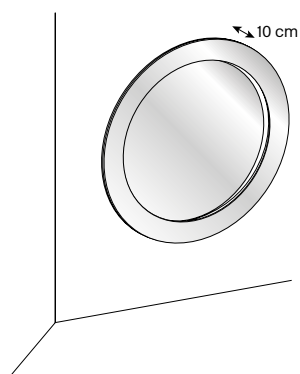

- Specchio / Mirror / Spiegel / Miroir
- Specchio fumè / Smoked mirror / Rauchglasspiegel / miroir fumé
- Specchio bronzo / Bronze mirror / Bronze Spiegel / Miroir bronze

- Specchiera da parete ricavata da un'unica lastra, con cornice inclinata. Struttura in legno verniciata nero.
 - Wall mirror made of an only sheet, with inclined frame. Structure in black lacquered wood.
 - Wandspiegel aus einer einzigen Platte produziert, mit schrägem Rahmen. Struktur aus schwarz lackiertem Holz.
 - Miroir au mur fait d'une seule plaque, avec encadrement incliné. Structure en bois laqué noir.

Gerundio

Ø196

4

0,55

131

□ 3.860

■ 4.130

■ 4.140

design G.T. Garattoni 2015

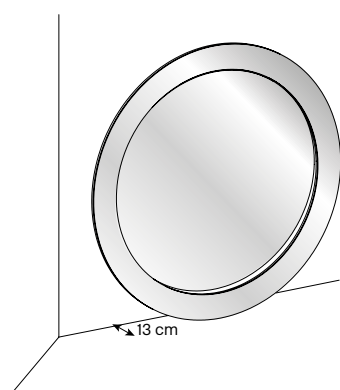

- Specchio / Mirror / Spiegel / Miroir
- Specchio fumè / Smoked mirror / Rauchglasspiegel / miroir fumé
- Specchio bronzo / Bronze mirror / Bronze Spiegel / Miroir bronze

- Specchiera da parete ricavata da un'unica lastra, con cornice inclinata. Struttura in legno verniciata nero.
 - Wall mirror made of an only sheet, with inclined frame. Structure in black lacquered wood.
 - Wandspiegel aus einer einzigen Platte produziert, mit schrägem Rahmen. Struktur aus schwarz lackiertem Holz.
 - Miroir au mur fait d'une seule plaque, avec encadrement incliné. Structure en bois laqué noir.

	I	dimensioni	spessore	volume	carico ammesso	peso	prezzo
	E	dimension	thickness	volume	admitted load	weight	price
	D	abmessungen	stärke	volumen	tragfähigkeit	gewicht	preis
	F	dimension	épaisseur	volume	charge admise	poids	prix
		cm	mm	m3	kg	kg	euro

Iris Tonelli design studio 2024	Ø120 x 14	6	0,49		47	●	3.220
						● ●	3.350
						● ● ●	3.420

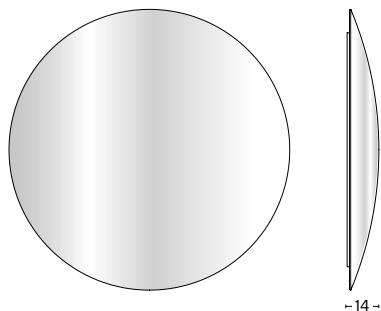

- 14 -

Optional illuminazione LED COB 3000K con telecomando / Optional LED COB 3000K lighting with remote control Option Illumination LED COB 3000K avec télécommande / Optionale LED COB 3000K Beleuchtung mit Fernbedienung	300
Optional illuminazione LED COB 3000K senza telecomando / Optional LED COB 3000K lighting without remote control Option Illumination LED COB 3000K sans télécommande / Optionale LED COB 3000K Beleuchtung ohne Fernbedienung	250

- Specchio / Mirror / Spiegel / Miroir
- ● Specchio fumè / Smoked mirror / Rauchglasspiegel / miroir fumé
- ● ● Specchio bronzo / Bronze mirror / Bronze Spiegel / Miroir bronze

Iris Tonelli design studio 2024	Ø150 x 17	6	0,87		63	●	3.960
						● ●	4.120
						● ● ●	4.210

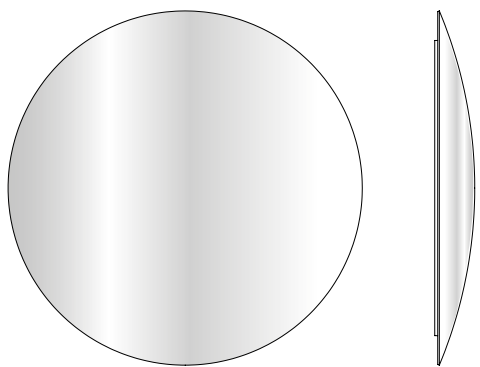

- 17 -

Optional illuminazione LED COB 3000K con telecomando / Optional LED COB 3000K lighting with remote control Option Illumination LED COB 3000K avec télécommande / Optionale LED COB 3000K Beleuchtung mit Fernbedienung	350
Optional illuminazione LED COB 3000K senza telecomando / Optional LED COB 3000K lighting without remote control Option Illumination LED COB 3000K sans télécommande / Optionale LED COB 3000K Beleuchtung ohne Fernbedienung	300

- Specchio / Mirror / Spiegel / Miroir
- ● Specchio fumè / Smoked mirror / Rauchglasspiegel / miroir fumé
- ● ● Specchio bronzo / Bronze mirror / Bronze Spiegel / Miroir bronze

- Specchio da parete in vetro curvo convesso, disponibile nelle finiture specchio normale, specchio fumè o specchio bronzo.
Optional illuminazione LED COB 3000K.
- Wall mirror in convex curved glass, available in finish clear mirror, smoked mirror or bronze mirror.
Optional LED COB lighting 3000K.
- Wandspiegel aus konvex gebogenem Glas, erhältlich in Ausführung Spiegel normal, Rauchglas Spiegel oder Bronze Spiegel.
Optionale LED COB-Beleuchtung 3000K.
- Miroir au mur en verre courbé convexe, disponible en finition verre clair, verre fumé ou verre bronze.
Optionnelle illumination LED COB 3000K.

	I	dimensioni	spessore	volume	carico ammesso	peso	prezzo
	E	dimension	thickness	volume	admitted load	weight	price
	D	abmessungen	stärke	volumen	tragfähigkeit	gewicht	preis
	F	dimension	épaisseur	volume	charge admise	poids	prix
		cm	mm	m3	kg	kg	euro

Iris Tonelli design studio 2024	Ø200x20	6	1,70				● 5.100
							●● 5.310
							●●● 5.420

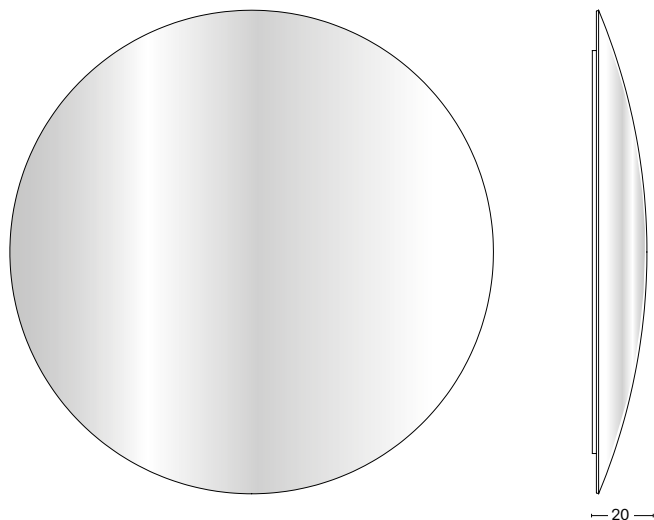

Optional illuminazione LED COB 3000K con telecomando / Optional LED COB 3000K lighting with remote control **390**
 Option Illumination LED COB 3000K avec télécommande / Optionale LED COB 3000K Beleuchtung mit Fernbedienung

Optional illuminazione LED COB 3000K senza telecomando / Optional LED COB 3000K lighting without remote control **340**
 Option Illumination LED COB 3000K sans télécommande / Optionale LED COB 3000K Beleuchtung ohne Fernbedienung

- Specchio / Mirror / Spiegel / Miroir
- Specchio fumè / Smoked mirror / Rauchglasspiegel / miroir fumé
- Specchio bronzo / Bronze mirror / Bronze Spiegel / Miroir bronze

- Specchio da parete in vetro curvo convesso, disponibile nelle finiture specchio normale, specchio fumè o specchio bronzo.
 Optional illuminazione LED COB 3000K.
 - Wall mirror in convex curved glass, available in finish clear mirror, smoked mirror or bronze mirror.
 Optional LED COB lighting 3000K.
 - Wandspiegel aus konvex gebogenem Glas, erhältlich in Ausführung Spiegel normal, Rauchglas Spiegel oder Bronze Spiegel.
 Optionale LED COB-Beleuchtung 3000K.
 - Miroir au mur en verre courbé convexe, disponible en finition verre clair, verre fumé ou verre bronze.
 Optionnelle illumination LED COB 3000K.

	I	dimensioni	spessore	volume	carico ammesso	peso	prezzo
	E	dimension	thickness	volume	admitted load	weight	price
	D	abmessungen	stärke	volumen	tragfähigkeit	gewicht	preis
	F	dimension	épaisseur	volume	charge admise	poids	prix
		cm	mm	m3	kg	kg	euro

Maybe

design Massimo Castagna 2021

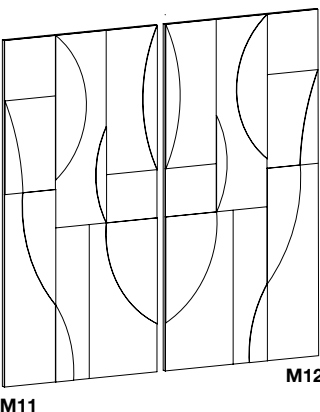
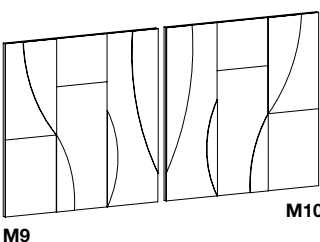
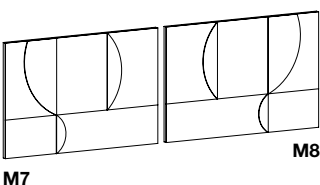
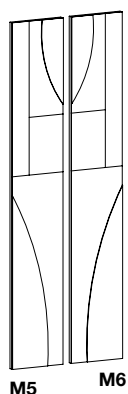
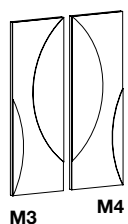
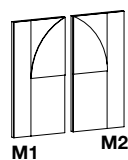

M1 30 x 3 x h 60	4	0,034		10	● 430 ●● 450 ●●● 460
M2 30 x 3 x h 60	4	0,034		10	● 430 ●● 450 ●●● 460
M3 30 x 3 x h 90	4	0,048		14	● 530 ●● 560 ●●● 570
M4 30 x 3 x h 90	4	0,048		14	● 530 ●● 560 ●●● 570
M5 30 x 3 x h 180	4	0,091		24	● 790 ●● 840 ●●● 850
M6 30 x 3 x h 180	4	0,091		24	● 790 ●● 840 ●●● 850
M7 90 x 3 x h 60	4	0,084		23	● 670 ●● 730 ●●● 740
M8 90 x 3 x h 60	4	0,084		23	● 670 ●● 730 ●●● 740
M9 90 x 3 x h 90	4	0,120		34	● 1.060 ●● 1.110 ●●● 1.120
M10 90 x 3 x h 90	4	0,120		34	● 1.060 ●● 1.110 ●●● 1.120
M11 90 x 3 x h 180	4	0,228		64	● 1.610 ●● 1.740 ●●● 1.750
M12 90 x 3 x h 180	4	0,228		64	● 1.610 ●● 1.740 ●●● 1.750

- Specchio / Mirror / Spiegel / Miroir
- Specchio fumè / Smoked mirror / Rauchglasspiegel / miroir fumé
- Specchio bronzo / Bronze mirror / Bronze Spiegel / Miroir bronze

- Specchio da parete modulare e componibile formato da specchi sovrapposti di diversa forma e dimensione. Disponibile in specchio, specchio fumè e bronzo. La struttura è sempre nera.
 - Modular wall mirror made of juxtaposed mirrors of different shapes and dimensions. Available in mirror, smoked mirror and bronze mirror. Structure is always black.
 - Modularer Wandspiegel aus übereinander gelegten Spiegeln in verschiedenen Formen und Maßen. Erhältlich in Spiegel, Rauchglasspiegel, und Bronze Spiegel. Struktur ist immer schwarz.
 - Miroir au mur modulaire composé de miroirs superposés en différents formes et dimensions. Disponible en miroir, miroir fumé et miroir bronze. La structure est toujours noire.

● 1.590
●● 1.670
●●● 1.690

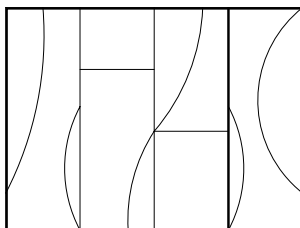

Comp. 1
120 x 3 x h 90 (M10+M3)

● 2.120
●● 2.220
●●● 2.240

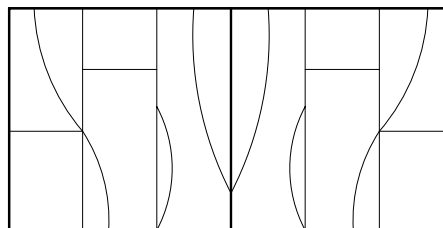

Comp. 2
180 x 3 x h 90 (M9+M10)

● 2.280
●● 2.470
●●● 2.490

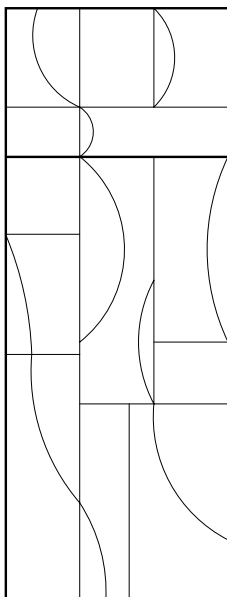

Comp. 3
90 x 3 x h 240 (M7+M11)

● 7.000
●● 7.520
●●● 7.600

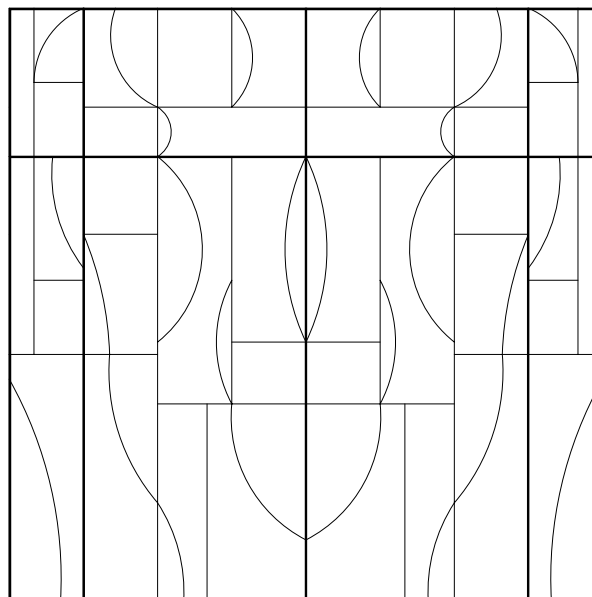

Comp. 4
240 x 3 x h 240 (M1+M7+M8+M2+M5+M11+M12+M6)

● 5.780
●● 6.230
●●● 6.290

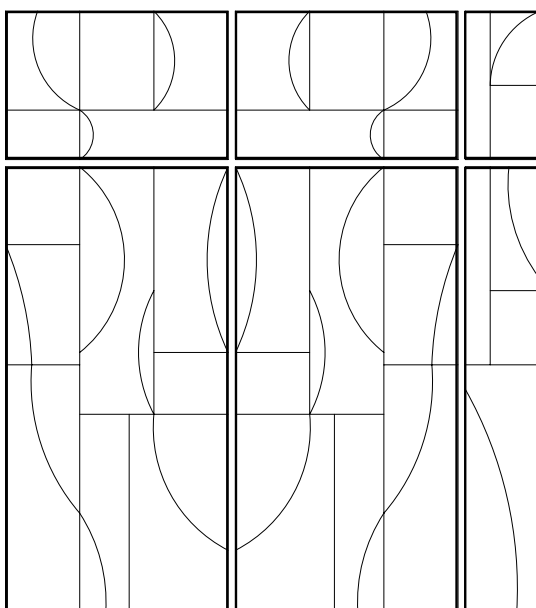

Comp. 5
216 x 3 x h 243 (M7+M8+M1+M11+M12+M5)

- Esempi di composizioni che si possono ottenere accostando tra di loro gli elementi di pagina 152.
- Examples of compositions given by joining elements of page 152
- Kompositionsbeispiele der Elemente auf Seite 152
- Exemples de compositions qu'on peut obtenir approchant les éléments de page 152

	I E D F	dimensioni dimension abmessungen dimension	spessore thickness stärke épaisseur	volume volume volumen volume	carico ammesso admitted load tragfähigkeit charge admise	peso weight gewicht poids	prezzo price preis prix
		cm	mm	m3	kg	kg	euro

Mercury Tonelli design studio 2026	Ø 150 x 17	6	0,87			63	● 3.960
							●● 4.120
							●●● 4.210

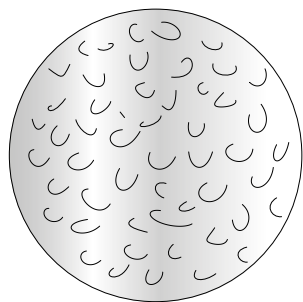

-17-

Optional illuminazione LED COB 3000K con telecomando / Optional LED COB 3000K lighting with remote control **350**
 Optionale LED COB 3000K Beleuchtung mit Fernbedienung / Option Illumination LED COB 3000K avec télécommande

Optional illuminazione LED COB 3000K senza telecomando / Optional LED COB 3000K lighting without remote control **300**
 Optionale LED COB 3000K Beleuchtung ohne Fernbedienung / Option Illumination LED COB 3000K sans télécommande

- Specchio / Mirror / Spiegel / Miroir
- Specchio fumè / Smoked mirror / Rauchglasspiegel / miroir fumé
- Specchio bronzo / Bronze mirror / Bronze Spiegel / Miroir bronze

Mercury Tonelli design studio 2024	Ø 200 x 20	6	1,70			84	● 5.100
							●● 5.310
							●●● 5.420

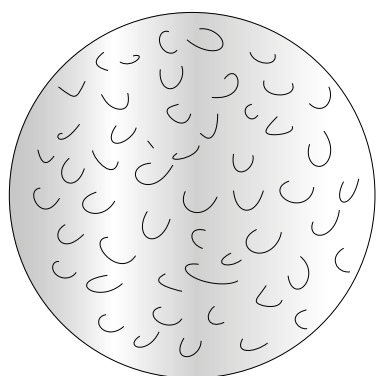

-20-

Optional illuminazione LED COB 3000K con telecomando / Optional LED COB 3000K lighting with remote control **390**
 Optionale LED COB 3000K Beleuchtung mit Fernbedienung / Option Illumination LED COB 3000K avec télécommande

Optional illuminazione LED COB 3000K senza telecomando / Optional LED COB 3000K lighting without remote control **340**
 Optionale LED COB 3000K Beleuchtung ohne Fernbedienung / Option Illumination LED COB 3000K sans télécommande

- Specchio / Mirror / Spiegel / Miroir
- Specchio fumè / Smoked mirror / Rauchglasspiegel / miroir fumé
- Specchio bronzo / Bronze mirror / Bronze Spiegel / Miroir bronze

- Specchio da parete in vetro curvo convesso effetto martellato, disponibile nelle finiture specchio normale, specchio fumè o specchio bronzo. Optional illuminazione LED.
 - Wall mirror in convex curved glass with a hammered effect, available in finish clear mirror, smoked mirror or bronze mirror. Optional LED lighting.
 - Wandspiegel aus gewölbtem Glas mit Hammerschlag-Effekt, erhältlich in Ausführung Spiegel normal, Rauchglas Spiegel oder Bronze Spiegel. Optionale LED Beleuchtung.
 - Miroir au mur en verre courbé convexe à effet martelé, disponible en finition miroir clair, miroir fumé ou miroir bronze. Optionnelle illumination LED.

	I	dimensioni	spessore	volume	carico ammesso	peso	prezzo
	E	dimension	thickness	volume	admitted load	weight	price
	D	abmessungen	stärke	volumen	tragfähigkeit	gewicht	preis
	F	dimension	épaisseur	volume	charge admise	poids	prix
		cm	mm	m3	kg	kg	euro

Mydear design Alessandro Corina 2026	160 x 13 x h 160	4	0,58		62	●	3.300
						● ●	3.380
						● ● ●	3.390

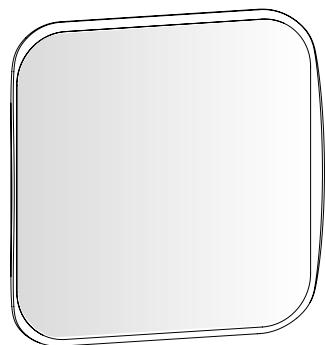

Optional illuminazione LED COB 3000K con accensione e regolazione touch
 Optional LED COB 3000K lighting with touch-sensitive switch and dimmer
 Optionale 3000K COB-LED-Beleuchtung mit Berührungsschalter und Einstellmöglichkeit
 Éclairage LED COB 3000K en option avec interrupteur tactile et réglage

Specificare sempre la finitura della struttura in legno **Siberian Ash, Eucalipto o Noce Canaletto**
 Always specify wood finish for structure **Siberian Ash, Eucalipto or Canaletto Walnut**
 Immer Holz Ausführung der Struktur angeben **Siberian Ash, Eucalipto oder Canaletto Nußbaum**
 Indiquer toujours finition bois de la structure **Siberian Ash, Eucalipto ou Noyer canaletto**

420

- Specchio / Mirror / Spiegel / Miroir
- Specchio fumè / Smoked mirror / Rauchglasspiegel / miroir fumé
- Specchio bronzo / Bronze mirror / Bronze Spiegel / Miroir bronze

- Specchio da parete con struttura in legno curvato nelle finiture Eucalipto, Siberian Ash e Noce Canaletto.
Specchio piano nelle finiture specchio, specchio fumè e specchio bronzo.
Optional kit illuminazione LED, su lato superiore e inferiore, con accensione e regolazione dell'intensità luminosa, touch sullo specchio.
- Wall mirror with curved wood frame in Eucalipto, Siberian Ash and Canaletto Walnut finishes.
Flat mirror clear, smoked or bronze finishes. Optional LED lighting kit on the top and bottom, with touch-sensitive switch and dimmer on the mirror.
- Wandspiegel mit gebogener Holzstruktur in den Ausführungen Eucalypto, Siberian Ash und Canaletto Nussbaum.
Flacher Spiegel in den Ausführungen Spiegel, Rauchglasspiegel und Bronze Spiegel.
Optionales LED-Beleuchtungsset oben und unten mit berührungsempfindlichem Schalter und Dimmer am Spiegel.
- Miroir mural avec structure en bois courbé, disponible en Eucalipto, Siberian Ash et Noyer Canaletto.
Miroir plat disponible en finitions miroir, miroir fumé et miroir bronze.
Kit d'éclairage LED optionnel en haut et en bas, avec interrupteur tactile et variateur sur le miroir.

	I	dimensioni	spessore	volume	carico ammesso	peso	prezzo
	E	dimension	thickness	volume	admitted load	weight	price
	D	abmessungen	stärke	volumen	tragfähigkeit	gewicht	preis
	F	dimension	épaisseur	volume	charge admise	poids	prix
		cm	mm	m3	kg	kg	euro

Ozma		Ø 100 x 5	4	0,15		39	2.380
design Viola Tonucci 2017							

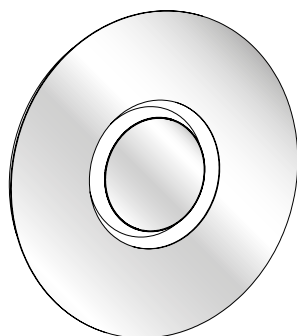

- Specchio tondo da parete. Parte centrale estraibile in finitura dorata, utilizzabile come centrotavola Ø 35 cm.
- Round wall mirror. Extractable central part in gold finish, that can be used as centrepiece Ø 35 cm.
- Runder Wandspiegel. Zentraler Teil in goldener Ausfertigung kann herausgenommen werden und als Tafelaufsatz benutzt werden Ø 35 cm.
- Miroir à mur ronde. Part central extractible en finition doré, utilisable comme pièce maîtresse Ø 35 cm.

	I	dimensioni	spessore	volume	carico ammesso	peso	prezzo
	E	dimension	thickness	volume	admitted load	weight	price
	D	abmessungen	stärke	volumen	tragfähigkeit	gewicht	preis
	F	dimension	épaisseur	volume	charge admise	poids	prix
		cm	mm	m3	kg	kg	euro

Soglia

Ø 50 x h 180

12 / 8

0,75

55

1.280

design Isao Hosoe 1989

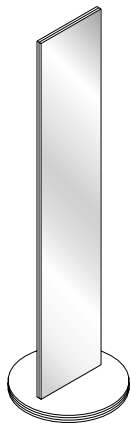

- Specchio bifacciale su base rotante.
- Double sided mirror on revolving base.
- Beidseitiger Spiegel auf drehbarer Basis.
- Miroir sur deux fronts sur base pivotante.

	I	dimensioni	spessore	volume	carico ammesso	peso	prezzo
	E	dimension	thickness	volume	admitted load	weight	price
	D	abmessungen	stärke	volumen	tragfähigkeit	gewicht	preis
	F	dimension	épaisseur	volume	charge admise	poids	prix
		cm	mm	m3	kg	kg	euro

Split design Francesco Forcellini 2024	120 x h 120 x 16	4	0,41		59	● 1.850
						●● 1.900
						●●● 1.910

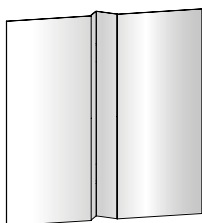

- Specchio / Mirror / Spiegel / Miroir
- Specchio fumè / Smoked mirror / Rauchglasspiegel / miroir fumé
- Specchio bronzo / Bronze mirror / Bronze Spiegel / Miroir bronze

- Specificare sempre la finitura dello specchio del taglio centrale a "V"
- Always specify mirror finish of the central "V" cut
- Immer Spiegelausführung des zentralen "V" Schnitt angeben
- Spécifier toujours finition du miroir du coupe central à « V »

Split design Francesco Forcellini 2024	200 x h 200 x 16	4	0,84		131	● 2.850
						●● 2.950
						●●● 2.960

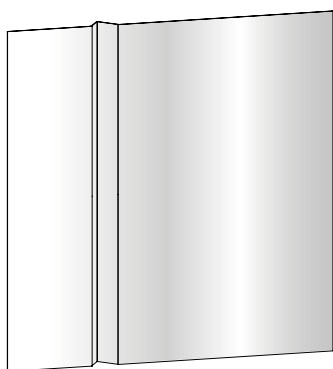

- Specchio / Mirror / Spiegel / Miroir
- Specchio fumè / Smoked mirror / Rauchglasspiegel / miroir fumé
- Specchio bronzo / Bronze mirror / Bronze Spiegel / Miroir bronze

- Specificare sempre la finitura dello specchio del taglio centrale a "V"
- Always specify mirror finish of the central "V" cut
- Immer Spiegelausführung des zentralen "V" Schnitt angeben
- Spécifier toujours finition du miroir du coupe central à « V »

Split design Francesco Forcellini 2024	120 x h 200 x 16	4	0,67		88	● 2.250
						●● 2.330
						●●● 2.340

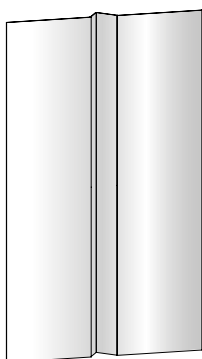

- Specchio / Mirror / Spiegel / Miroir
- Specchio fumè / Smoked mirror / Rauchglasspiegel / miroir fumé
- Specchio bronzo / Bronze mirror / Bronze Spiegel / Miroir bronze

- Specificare sempre la finitura dello specchio del taglio centrale a "V"
- Always specify mirror finish of the central "V" cut
- Immer Spiegelausführung des zentralen "V" Schnitt angeben
- Spécifier toujours finition du miroir du coupe central à « V »

- Specchio da parete disponibile in diverse forme e dimensioni. Il taglio centrale a "V" che separa i pannelli laterali è rivestito a specchio. Le finiture disponibili sono: specchio normale, specchio fumè o specchio bronzo.
- Wall mirror available in different shapes and sizes. The V-shaped central cut separating the side panels is covered in mirror. Available finishes are: clear mirror, smoked mirror or bronze mirror.
- Wandspiegel erhältlich in verschiedenen Formen und Maße. Der zentrale „V“ Schnitt der die Seitenpaneele trennt ist mit Spiegel überzogen. Erhältliche Ausführungen sind: normaler Spiegel, Rauchglas Spiegel und Bronze Spiegel.
- Miroir au mur disponible en différentes formes et mesures. La coupe centrale à «V» qui sépare les deux panneaux latéraux è revêtu en miroir. Les finitions disponibles sont: miroir clair, miroir fumé ou miroir bronze.

	I	dimensioni	spessore	volume	carico ammesso	peso	prezzo
	E	dimension	thickness	volume	admitted load	weight	price
	D	abmessungen	stärke	volumen	tragfähigkeit	gewicht	preis
	F	dimension	épaisseur	volume	charge admise	poids	prix
		cm	mm	m3	kg	kg	euro

Split design Francesco Forcellini 2024	200 x h 120 x 16	4	0,54		87	● 2.280
						●● 2.360
						●●● 2.370

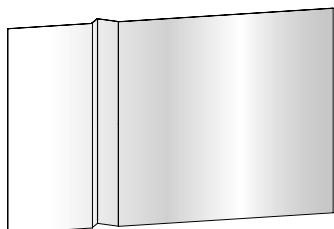

- Specchio / Mirror / Spiegel / Miroir
- Specchio fumè / Smoked mirror / Rauchglasspiegel / miroir fumé
- Specchio bronzo / Bronze mirror / Bronze Spiegel / Miroir bronze

- Specificare sempre la finitura dello specchio del taglio centrale a "V"
- Always specify mirror finish of the central "V" cut
- Immer Spiegelausführung des zentralen "V" Schnitt angeben
- Spécifier toujours finition du miroir du coupe central à « V »

Split design Francesco Forcellini 2024	Ø 150 x 16	4	0,51		71	● 2.280
						●● 2.370
						●●● 2.380

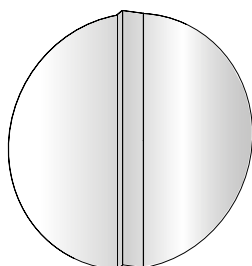

- Specchio / Mirror / Spiegel / Miroir
- Specchio fumè / Smoked mirror / Rauchglasspiegel / miroir fumé
- Specchio bronzo / Bronze mirror / Bronze Spiegel / Miroir bronze

- Specificare sempre la finitura dello specchio del taglio centrale a "V"
- Always specify mirror finish of the central "V" cut
- Immer Spiegelausführung des zentralen "V" Schnitt angeben
- Spécifier toujours finition du miroir du coupe central à « V »

Split design Francesco Forcellini 2024	Ø 200 x 16	4	0,67		104	● 2.830
						●● 2.930
						●●● 2.940

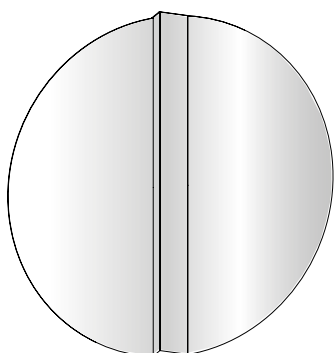

- Specchio / Mirror / Spiegel / Miroir
- Specchio fumè / Smoked mirror / Rauchglasspiegel / miroir fumé
- Specchio bronzo / Bronze mirror / Bronze Spiegel / Miroir bronze

- Specificare sempre la finitura dello specchio del taglio centrale a "V"
- Always specify mirror finish of the central "V" cut
- Immer Spiegelausführung des zentralen "V" Schnitt angeben
- Spécifier toujours finition du miroir du coupe central à « V »

- Specchio da parete disponibile in diverse forme e dimensioni.
Il taglio centrale a "V" che separa i pannelli laterali è rivestito a specchio.
Le finiture disponibili sono: specchio normale, specchio fumè o specchio bronzo.

- Wall mirror available in different shapes and sizes.
The V-shaped central cut separating the side panels is covered in mirror.
Available finishes are: clear mirror, smoked mirror or bronze mirror.

- Wandspiegel erhältlich in verschiedenen Formen und Maße.
Der zentrale „V“ Schnitt der die Seitenpaneele trennt ist mit Spiegel überzogen.
Erhältliche Ausführungen sind: normaler Spiegel, Rauchglas Spiegel und Bronze Spiegel.

- Miroir au mur disponible en différentes formes et mesures.
La coupe centrale à «V» qui sépare les deux panneaux latéraux è revêtu en miroir.
Les finitions disponibles sont: miroir clair, miroir fumé ou miroir bronze.

	I	dimensioni	spessore	volume	carico ammesso	peso	prezzo
	E	dimension	thickness	volume	admitted load	weight	price
	D	abmessungen	stärke	volumen	tragfähigkeit	gewicht	preis
	F	dimension	épaisseur	volume	charge admise	poids	prix
		cm	mm	m3	kg	kg	euro

Stati d'animo	40 x 40	4	0,015		4	●	170
	design Garattoni - De Angelis 2002					●●	180
						●●●	190

convesso
convex
konvex
convexe

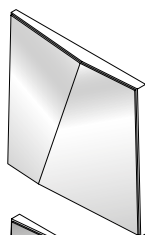

- Barra per fissaggio n° 2 specchi / Bar to fix nr.2 mirrors
- Stange für Montage von 2 Spiegeln / Tige pour le fixation de 2 miroirs

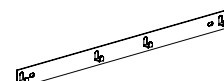

40

concavo
concave
konkav
concave

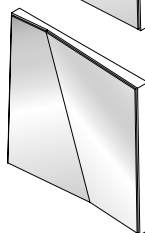

- Barra per fissaggio n° 3 specchi / Bar to fix nr.3 mirrors
- Stange für Montage von 3 Spiegeln / Tige pour le fixation de 3 miroirs

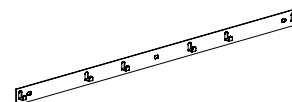

50

- Specchio / Mirror / Spiegel / Miroir
- Specchio fumè / Smoked mirror / Rauchglasspiegel / miroir fumé
- Specchio bronzo / Bronze mirror / Bronze Spiegel / Miroir bronze

- Piccoli specchi quadrati concavi o convessi.
- Small concave or convex square mirrors.
- Kleine viereckige, konkave oder konvexe Spiegel.
- Petits miroirs carrés concaves et convexes.

	I	dimensioni	spessore	volume	carico ammesso	peso	prezzo
	E	dimension	thickness	volume	admitted load	weight	price
	D	abmessungen	stärke	volumen	tragfähigkeit	gewicht	preis
	F	dimension	épaisseur	volume	charge admise	poids	prix
		cm	mm	m3	kg	kg	euro

VU 90 design G.T. Garattoni 2013	30 x 9 x h 90	10 / 12 / 15 / 20	0,04			32	2.120
	30 x 3 x h 90	5	0,03			4	● 480

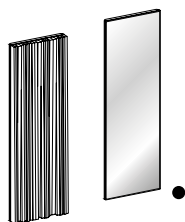

- solo specchio / only mirror / nur Spiegel / seulement miroir

- Specchio Modulare, realizzato con fasce di vetro extrachiaro incollate tra di loro. Disponibile in due misure.
 - Modular mirror, made with extra clear glass strips glued together. Available in two sizes
 - Modularer Spiegel, aus extrahellen zusammengeklebten Glasstreifen. In zwei Maßen erhältlich.
 - Miroir modulaire, réalisé avec bandes de verre extra clair collés. Disponible en deux mesures.

VU 200 design G.T. Garattoni 2013	30 x 9 x h 200	10 / 12 / 15 / 20	0,09			69	3.960
	30 x 3 x h 200	5	0,06			10	● 630

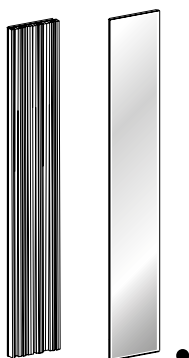

- solo specchio / only mirror / nur Spiegel / seulement miroir

- Specchio Modulare, realizzato con fasce di vetro extrachiaro incollate tra di loro. Disponibile in due misure.
 - Modular mirror, made with extra clear glass strips glued together. Available in two sizes.
 - Modularer Spiegel, aus extrahellen zusammengeklebten Glasstreifen. In zwei Maßen erhältlich.
 - Miroir modulaire, réalisé avec bandes de verre extra clair collés. Disponible en deux mesures.

console | consoles

	I E D F	dimensioni dimension abmessungen dimension	spessore thickness stärke épaisseur	volume volume volumen volume	carico ammesso admitted load tragfähigkeit charge admise	peso weight gewicht poids	prezzo price preis prix
		cm	mm	m3	kg	kg	euro

Gotham consolle

120 x 45 x h 80

12

0,65

50

74

■ 1.920

■ 1.960

design Leonardi_Marinelli 2026

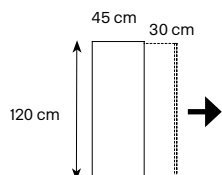
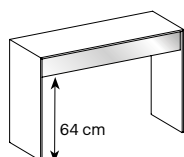

- Vetro fumé / smoked glass / Rauchglas / verre fumé
- Vetro bronzo / bronze glass / Glas Bronze / verre bronze

**Specificare sempre la finitura del cassetto / always specify finish of drawer
immer Ausführung des Schubalde angeben / toujours spécifier la finition de tiroir**

Maggiorazione per finitura frontale **specchio fumé o specchio bronzo**
Surcharge for front finishing in **smoked or bronze mirror**
Aufpreis für frontale Ausfertigung in **Rauchglas- oder Bronze Spiegel**
Augmentation pour frontal en finition **miroir fumé ou bronze**

60

- Consolle con struttura in vetro fumé o bronzo. Cassetto in legno Siberian Ash, Eucalipto o noce canaletto, con chiusura soft. Frontale disponibile anche in specchio fumé o bronzo.
- Console with smoked glass or bronze structure. Drawer in Siberian Ash, Eucalipto or Canaletto walnut, with soft-close mechanism. Front also available in smoked mirror or bronze mirror.
- Konsole mit Struktur aus Rauchglas oder Bronze Glas. Schublade aus Holz Siberian Ash, Eucalipto oder Walnuß Canaletto mit Softsperrung. Frontal auch in Rauchglas oder Bronze Spiegel verfügbar.
- Console avec structure en verre fumé ou bronze. Tiroir en bois Siberian Ash, Eucalipto ou noyer canaletto avec fermeture soft. Frontal aussi disponible en miroir fumé ou bronze.

	I E D F	dimensioni dimension abmessungen dimension	spessore thickness stärke épaisseur	volume volume volumen volume	carico ammesso admitted load tragfähigkeit charge admise	peso weight gewicht poids	prezzo price preis prix
		cm	mm	m3	kg	kg	euro

Gulliver design Tonelli design studio	115 x 45 x h 70	15	0,638	40	56	□ 1.210
	140 x 45 x h 70	15	0,749	40	63	□ 1.290

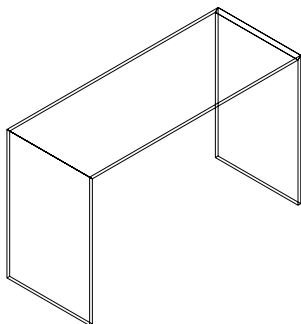

□ Vetro extrachiario / extra clear glass / extrahelles Glas / verre extra clair

Gulliver 2 design Tonelli design studio	115 x 45 x h 80	15	0,638	40	58	□ 1.480
---	-----------------	----	-------	----	----	---------

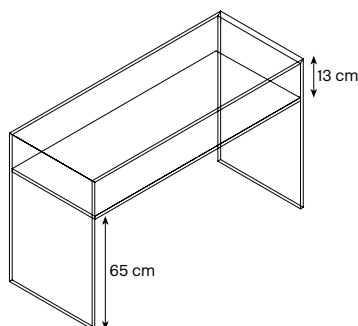

□ Vetro extrachiario / extra clear glass / extrahelles Glas / verre extra clair

- Consolle / scrivania in vetro extrachiario. Disponibile con dimensioni a richiesta.
- Console / desk in extra clear glass. Special sizes available.
- Konsole oder Schreibtisch aus extrahellem Glas. Sondermaß sind möglich.
- Consolle ou bureau en verre extra clair. Dimensions spéciales sur demande.

Cassetti / Drawer / Schublade / Tiroir

U

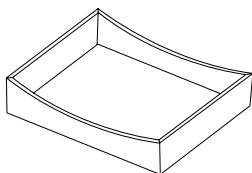

U 54,5 x 44,5 x h 12

Eucalipto Siberian Ash	0,068		5	380
noce canaletto canaletto walnut Walnuß canaletto noyer canaletto	0,068		5	380
RAL	0,068		5	360

H

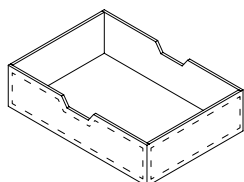

H 54,5 x 44,5 x h 12

Cassetto cuoio naturale o nero Natural or black leather drawer Schublade in Leder natur oder schwarz Tiroir en cuir naturel ou noir	0,068		5	580
--	-------	--	---	-----

	I	dimensioni	spessore	volume	carico ammesso	peso	prezzo
	E	dimension	thickness	volume	admitted load	weight	price
	D	abmessungen	stärke	volumen	tragfähigkeit	gewicht	preis
	F	dimension	épaisseur	volume	charge admise	poids	prix
		cm	mm	m3	kg	kg	euro
Liber H		80 x 40 x h 80	12 / 10	0,41	15 *	65	□ 1.560
design Luca Papini 2015/2019							■ 1.640
							■ 1.680

Optional CASSETTO C3 / Optional CASSETTO C3 / Opzional CASSETTO C3 / Optionnel CASSETTO C3

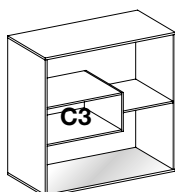

- * ogni ripiano / on each shelf / auf jedem Bord / pour chaque étagère
- Vetro extrachiaro / extra clear glass / extrahelles Glas / verre extra clair
- Vetro fumé / smoked glass / Rauchglas / verre fumé
- Vetro bronzo / bronze glass / Bronze Glas / Verre bronze

Ripiano superiore cassetto in vetro acidato / laccato ral / vetro a specchio 100
 Top drawer shelf in frosted glass / ral lacquered glass / mirrored glass
 Glasplatte über Laden in geätztem/ral lackiertem / verspiegeltem Glas
 Étagère supérieur tiroir en verre mordancé / lacqué ral / miroir

- Console in vetro con base a specchio e piedini regolabili. Cassetti optional.
 - Console in glass with mirrored base and adjustable feet. Optional drawers.
 - Konsole aus Glas mit verspiegeltem Boden und verstellbaren Füßen. Optionale Schubladen.
 - Console en verre avec base en miroir et pieds réglables. Tiroirs optionnels.

Liber cassetto design Luca Papini 2013/2022	C1 19 x 40 x h 25		0,03	15	2,5	● 290
						●● 300
						●●● 340
						●●●● 460
C1 	C2 25 x 40 x h 19		0,03	15	2,5	● 290
						●● 300
						●●● 340
						●●●● 460
C2 	C3 45 x 40 x h 19		0,06	15	4,5	● 330
						●● 340
						●●● 360
						●●●● 490
C3 						

- Cassetto in legno laccato in finitura bianco opaco con foro bifacciale.
- Drawer in matt white lacquered wood with double sided opening.
- Schublade aus Holz matt weiß lackiert mit beidseitiger Öffnung.
- Tiroir en bois laqué mat blanc avec trou biface.

- Cassetto in legno laccato in finitura RAL opaco con foro bifacciale
- Drawer in matt RAL lacquered wood with double sided opening.
- Schublade aus Holz matt RAL lackiert mit beidseitiger Öffnung.
- Tiroir en bois laqué mat RAL avec trou biface.

- Cassetto in legno SIBERIAN ASH, EUCALIPTO e Noce Canaletto con maniglia in pelle.
- Wooden drawer in SIBERIAN ASH, EUCALIPTO and Canaletto Walnut with leather knob.
- Holzschublade aus SIBERIAN ASH, EUCALIPTO und Canaletto Walnuß mit Ledergriff.
- Tiroir en bois SIBERIAN ASH, EUCALIPTO et Noyer Canaletto avec pommeau en cuir.

- Cassetto in cuoio testa di moro con una maniglia.
- Drawer in dark leather with one handle.
- Schublade aus dunklem Leder mit einem Griff.
- Tiroir en cuir Tête-De-Maure avec un pommeau.

	I E D F	dimensioni dimension abmessungen dimension	spessore thickness stärke épaisseur	volume volume volumen volume	carico ammesso admitted load tragfähigkeit charge admise	peso weight gewicht poids	prezzo price preis prix
		cm	mm	m3	kg	kg	euro
Marcell Console design Massimo Castagna 2021	E	130 x 45 x h 75	12	0,688	60 + 10 *	64	<input type="checkbox"/> 1.780 <input checked="" type="checkbox"/> 1.860
	D	150 x 45 x h 75	12	0,792	60 + 10 *	73	<input type="checkbox"/> 2.250 <input checked="" type="checkbox"/> 2.330
	B	150 x 45 x h 75	12	0,792	60 + 10 *	73	<input type="checkbox"/> 2.860 <input checked="" type="checkbox"/> 2.970

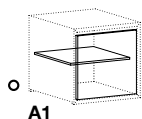
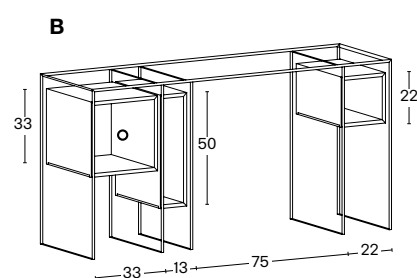
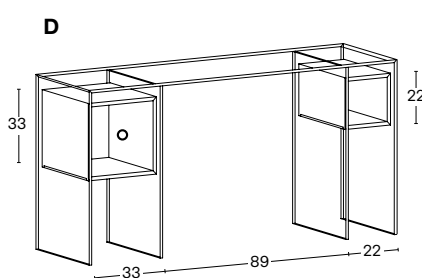
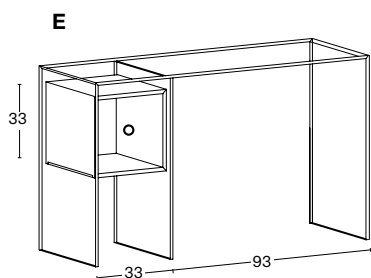

* per ogni contenitore / for each storage unit / für jeden Behälter / pour chaque récipient

- vetro extrachiaro / extra clear glass / extrahelles Glas / verre extra clair
 vetro fumè / smoked glass / Rauchglas / verre fumé

A1 Optional anta battente SX in finitura Eucalipto, Siberian Ash o Rovere Naturale e ripiano interno in vetro **240**
 Optional hinge door left in finish Eucalipto, Siberian Ash or natural oak and internal glass shelf
 Optional Drehflügel Tür links aus Eucalipto, Siberian Ash oder Eiche Natur und internes Glasfach
 Option porte à battant gauche en Eucalipto, Siberian Ash ou rouvre naturel et étagère en verre intérieur

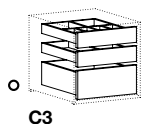

C3 Optional set 3 cassetti portaoggetti, completi di separatori in legno, **580**
 in finitura Eucalipto, Siberian Ash o Rovere Naturale
 Optional set of 3 glove box drawers, including wooden partition,
 in Eucalipto, Siberian Ash or natural oak
 Optional set von 3 Handschuhfächern, komplett mit innerer Abtrennung aus Holz,
 aus Eucalipto, Siberian Ash oder Eiche Natur
 Option set de 3 tiroirs boîte à gants, complet de cloisons en bois,
 en finition Eucalipto, Siberian Ash ou rouvre naturel

Specificare la finitura in legno dei contenitori e degli optional SIBERIAN ASH, EUCALIPTO o ROVERE NATURALE
Specify wood finish of storage unit and optional elements SIBERIAN ASH, EUCALIPTO or NATURAL OAK
Holzausführung der Behälter und optionalen Teile angeben SIBERIAN ASH, EUCALIPTO oder EICHE NATUR
Indiquer finition bois des récipients et des éléments optionnels SIBERIAN ASH, EUCALIPTO ou ROUVRE NATUREL

- Consolle o dressing table con struttura incollata in vetro e contenitori in legno in finitura Eucalipto, Siberian Ash o Rovere Naturale.
Optional anta battente SX o set 3 cassetti in finitura abbinata.
- Console or dressing table with glued structure made of glass and wooden storage units in Eucalipto, Siberian Ash or natural oak finish.
Optional hinge door left or set of 3 glove box drawers in matching finish.
- Konsole oder Frisiertisch mit verklebter Struktur aus Glas und Behälter aus Holz in Ausführung Eucalipto, Siberian Ash oder Eiche Natur.
Optional Drehflügel Tür links oder set von 3 Handschuhfächern in kombinierter Ausführung.
- Consolle ou coiffeuse avec structure collée en verre et récipients en bois en finition Eucalipto, Siberian Ash ou rouvre naturel.
Optionnelle porte à battant gauche ou set de 3 tiroirs boîte à gants en finition assorti.

	I E D F	dimensioni dimension abmessungen dimension	spessore thickness stärke épaisseur	volume volume volumen volume	carico ammesso admitted load tragfähigkeit charge admise	peso weight gewicht poids	prezzo price preis prix
		cm	mm	m3	kg	kg	euro

Metropolis consolle

design G. Maurizio Scutellà 2017

120 x 45 x h 75

12

0,37

50

67

1.520

1.570

1.640

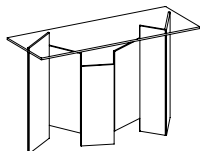

- basamento e piano vetro extrachiaro / extra clear glass base and top
Gestell und Tischplatte aus extrahellem Glas / piètement et top verre extra clair
- basamento e piano vetro fumè / smoked glass base and top
Gestell und Tischplatte aus Rauchglas / piètement et top verre fumé
- basamento e piano vetro bronzo / bronze glass base and top
Gestell und Tischplatte aus Bronze Glas / piètement et top verre bronze

- Consolle con basamento in vetro extrachiaro, fumè o bronzo. Top in vetro extrachiaro, fumè o bronzo.
- Console with base in extra clear, smoked or bronze glass. Top in extra clear, smoked or bronze glass.
- Konsole mit Gestell aus extrahellem Glas, Rauchglas oder Bronze. Top aus extrahellem Glas, Rauchglas oder Bronze.
- Console avec piètement en verre extra clair, fumé ou bronze. Top en verre extra clair, fumé ou bronze.

Metropolis ceramic console

design G. Maurizio Scutellà 2017

105 x 45 x h 75

12 / 8 + 5

0,37

50

61

1.620

1.660

1.700

120 x 45 x h 75

12 / 8 + 5

0,42

50

72

1.890

1.930

1.970

160 x 45 x h 75

12 / 8 + 5

0,56

50

83

2.200

2.240

2.290

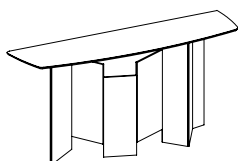

- basamento in vetro extrachiaro / base in extra clear glass
Gestell aus extrahellem Glas / piètement en verre extra clair
- basamento in vetro fumè / base in smoked glass
Gestell aus Rauchglas / piètement en verre fumé
- basamento in vetro bronzo / base in bronze glass
Gestell aus Bronze Glas / piètement en verre bronze

- Consolle con basamento in vetro extrachiaro, fumè o bronzo. Top in ceramica+vetro nelle seguenti finiture:
Pietra di Savoia antracite bocciardato, Noir desir lucido o opaco, Calacatta oro venato lucido, Pietra Grey opaco, Sahara noir lucido o bocciardato e Travertino.
- Console with base in extra clear, smoked or bronze glass. Top made of ceramic+glass with following finishes:
Pietra di Savoia anthracite bushhammered, Noir desir polished or matt, Calacatta oro venato polished, Pietra Grey matt, Sahara noir polished or bushhammered and Travertino.
- Konsole mit Gestell in extrahellem Glas, Rauchglas oder Bronze. Top aus Keramik+Glas in folgenden Ausfertigungen:
Pietra di Savoia Anthrazit bocciardato, Noir desir glänzend oder matt, Calacatta oro venato glänzend, Pietra Grey matt, Sahara noir glänzend oder bocciardato und Travertino.
- Console avec piètement en verre extra clair, fumé ou bronze. Top en céramique+verre dans les suivants finitions:
Pietra di Savoia anthracite bouchardé, Noir desir brillant ou mat, Calacatta oro venato brillant, Pietra Grey mat, Sahar noir brillant ou bouchardé et Travertino.

	I E D F	dimensioni dimension abmessungen dimension	spessore thickness stärke épaisseur	volume volume volumen volume	carico ammesso admitted load tragfähigkeit charge admise	peso weight gewicht poids	prezzo price preis prix
		cm	mm	m3	kg	kg	euro

Penrose Console

120 x 48 x h 75

15

0,61

40

42

□ 1.820

design Isao Hosoe 2013
con Lucia Fontana e Masaya Hashimoto

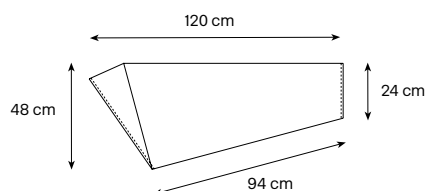
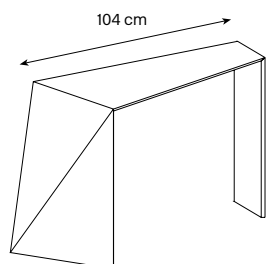

□ Vetro extrachiaro / extra clear glass / Glas extrahell / verre extra clair

- Consolle o scrittoio di forma irregolare. Disponibile in vetro extrachiaro.
- Irregular shaped console or desk. Available in extra clear glass.
- Konsole oder Schreibtisch in irregulärer Form. In extrahellem Glas.
- Console ou bureau de forme irrégulière. Disponible en verre extra clair.

Quiller console

120 x 45 x h 85

15

0,727

40

82

1.780

design Uto Balmoral 2016

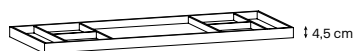
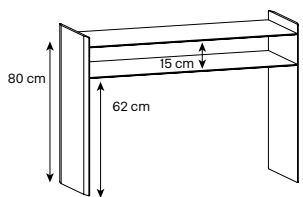

Vassoio in legno massello noce canaletto / **Tray** in solid walnut canaletto wood
Holztablett massiv Walnuss Canaletto / **Plateau** en noyer canaletto massif

740

- Consolle/scrivania in vetro extrachiaro con bisellatura da 5cm. Opzionale vassoio in legno massello noce canaletto.
- Console/desk in extra clear glass with 5cm bevelling. Optional tray in solid walnut canaletto wood.
- Konsoltisch in extrahellem Glas mit 5cm Schrägkante. Optionales Holztablett massiv Walnuss canaletto.
- Console/bureau en verre extra clair avec biseautage de 5cm. Optionnel plateau en bois noyer canaletto massif.

	I E D F	dimensioni dimension abmessungen dimension	spessore thickness stärke épaisseur	volume volume volumen volume	carico ammesso admitted load tragfähigkeit charge admise	peso weight gewicht poids	prezzo price preis prix
		cm	mm	m3	kg	kg	euro
Sestante design Emilio Nanni 2019		120 x 40 x h 72	10	0,55	40	67	<input type="checkbox"/> 1.160 <input checked="" type="checkbox"/> 1.220 <input checked="" type="checkbox"/> 1.290
		150 x 40 x h 72	10	0,68	40	80	<input type="checkbox"/> 1.340 <input checked="" type="checkbox"/> 1.400 <input checked="" type="checkbox"/> 1.470

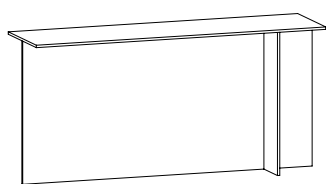

- Vetro extrachiaro / extra clear glass / extrahelles Glas / verre extra clair
- Vetro fumé / smoked glass / Rauchglas / verre fumé
- Vetro bronzo / bronze glass / Bronze Glas / Verre bronze

- Consolle in vetro extrachiaro, fumé e bronzo.
- Console in extra clear, smoked and bronze glass.
- Konsole aus extrahellem Glas, Rauchglas und Bronze Glas.
- Console en verre extra clair, fumé et bronze.

	I	dimensioni	spessore	volume	carico ammesso	peso	prezzo
	E	dimension	thickness	volume	admitted load	weight	price
	D	abmessungen	stärke	volumen	tragfähigkeit	gewicht	preis
	F	dimension	épaisseur	volume	charge admise	poids	prix
		cm	mm	m3	kg	kg	euro

Sestante_Stone design Emilio Nanni 2020	120 x 40 x h 73	10 / 20	0,55	40	80	△ 1.980	▲ 2.020
						△△ 2.590	▲▲ 2.630
						△△△ 3.340	▲▲▲ 3.380
	150 x 40 x h 73	10 / 20	0,68	40	96	△ 2.670	▲ 2.730
						△△ 3.080	▲▲ 3.130
						△△△ 3.630	▲▲▲ 3.680
	180 x 40 x h 73	10 / 20	0,81	40	112	△ 2.730	▲ 2.790
						△△ 3.550	▲▲ 3.610
						△△△ 4.220	▲▲▲ 4.280

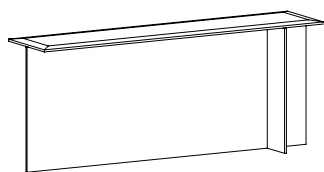

- △ base vetro extrachiaro, top marmo Arabescato Orobico Gold
extra clear base, top in Arabescato Orobico Gold marble
Gestell aus extrahellem Glas, Top in Marmor Arabescato Orobico Gold
base en verre extra clair, top en marbre Arabescato Orobico Gold
- △△ base vetro extrachiaro, top marmo Tropikal Storm
extra clear base, top in Tropikal Storm marble
Gestell aus extrahellem Glas, Top in Marmor Tropikal Storm
base en verre extra clair, top en marbre Tropikal Storm
- △△△ base vetro extrachiaro, top marmo Domus White
base en verre extra clair, top in Domus White marble
Gestell aus extrahellem Glas, Top in Marmor Domus White
base en verre extra clair, top en marbre Domus White

- ▲ base vetro fumè o bronzo, top marmo Arabescato Orobico Gold
base in smoked or bronze glass, top in Arabescato Orobico Gold marble
Gestell aus Rauchglas oder Bronze Glas, Top in Marmor Arabescato Orobico Gold
base en verre fumé ou bronze, top en marbre Arabescato Orobico Gold
- ▲▲ base vetro fumè o bronzo, top marmo Tropikal Storm
base in smoked or bronze glass, top in Tropikal Storm marble
Gestell aus Rauchglas oder Bronze Glas, Top in Marmor Tropikal Storm
base en verre fumé ou bronze, top en marbre Tropikal Storm
- ▲▲▲ base vetro fumè o bronzo, top marmo Domus White
base in smoked or bronze glass, top in Domus White marble
Gestell aus Rauchglas oder Bronze Glas, Top in Marmor Domus White
base en verre fumé ou bronze, top en marbre Domus White

- Consolle con base in vetro extrachiaro, fumè o bronzo.
Top in marmo bisellato, disponibile in **Arabescato Orobico Gold, Tropikal Storm o Domus white.**
- Console with base in extra clear, smoked or bronze glass.
Top in bevelled marble, available in **Arabescato Orobico Gold, Tropikal Storm or Domus White.**
- Consolle mit Gestell aus extrahellem Glas, Rauchglas oder Bronze.
Top in Marmor mit Facettenschliff, erhältlich in **Arabescato Orobico Gold, Tropikal Storm oder Domus White.**
- Console avec base en verre extra clair, fumé ou bronze.
Top en marbre biseauté, disponible en **Arabescato Orobico Gold, Tropikal Storm ou Domus White.**

librerie | bookcases

	I E D F	dimensioni dimension abmessungen dimension	spessore thickness stärke épaisseur	volume volume volumen volume	carico ammesso admitted load tragfähigkeit charge admise	peso weight gewicht poids	prezzo price preis prix
		cm	mm	m3	kg	kg	euro

Liber A

design Luca Papini 2013/2022

80 x 40 x h 200	10 / 12	0,99	15 *	130	<input type="checkbox"/> 2.950 <input checked="" type="checkbox"/> 3.080 <input type="checkbox"/> 3.180
80 x 40 x h 240	10 / 12	1,19	15 *	165	<input type="checkbox"/> 3.750 <input checked="" type="checkbox"/> 3.890 <input type="checkbox"/> 3.990

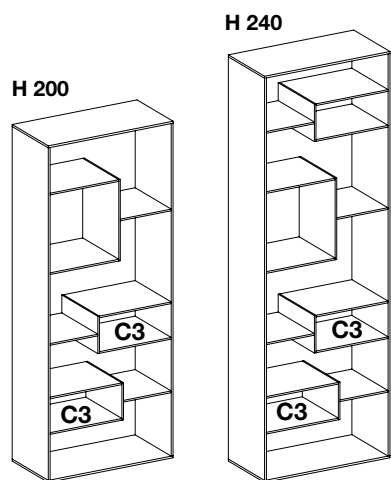

Optional CASSETTO C3 / Optional CASSETTO C3 Opzional CASSETTO C3 / Optionnel CASSETTO C3

* ogni ripiano / on each shelf / auf jedem Bord / pour chaque étagère

- Vetro extrachiaro / extra clear glass / extrahelles Glas / verre extra clair
- Vetro fumé / smoked glass / Rauchglas / verre fumé
- Vetro bronzo / bronze glass / Bronze Glas / Verre bronze

Ripiano superiore cassetto in vetro acidato / laccato ral / vetro a specchio 100
 Top drawer shelf in frosted glass / ral lacquered glass / mirrored glass
 Glasplatte über Laden in geätztem/ral lackiertem / verspiegeltem Glas
 Étagère supérieur tiroir en verre mordancé / lacqué ral / miroir

- Libreria o espositore in vetro con base a specchio e piedini regolabili. Cassetti optional.
- Glass bookcase or showcase with mirrored base and adjustable feet. Optional drawers.
- Bücherregal oder Regal aus Glas mit verspiegeltem Boden und regelbaren Füßen. Optionale Schubladen.
- Bibliothèque ou présentoir en verre avec base en miroir e pieds réglables. Tiroirs optionnels.

Liber B

design Luca Papini 2013/2022

40 x 40 x h 200	10 / 12	0,56	15 *	100	<input type="checkbox"/> 2.470 <input checked="" type="checkbox"/> 2.560 <input type="checkbox"/> 2.670
40 x 40 x h 240	10 / 12	0,67	15 *	118	<input type="checkbox"/> 2.980 <input checked="" type="checkbox"/> 3.120 <input type="checkbox"/> 3.180

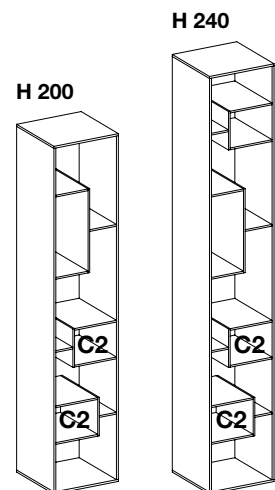

Optional CASSETTO C2 / Optional CASSETTO C2 Opzional CASSETTO C2 / Optionnel CASSETTO C2

* ogni ripiano / on each shelf / auf jedem Bord / pour chaque étagère

- Vetro extrachiaro / extra clear glass / extrahelles Glas / verre extra clair
- Vetro fumé / smoked glass / Rauchglas / verre fumé
- Vetro bronzo / bronze glass / Bronze Glas / Verre bronze

Ripiano superiore cassetto in vetro acidato / laccato ral / vetro a specchio 80
 Top drawer shelf in frosted glass / ral lacquered glass / mirrored glass
 Glasplatte über Laden in geätztem/ral lackiertem / verspiegeltem Glas
 Étagère supérieur tiroir en verre mordancé / lacqué ral / miroir

- Libreria o espositore in vetro con base a specchio e piedini regolabili. Cassetti optional.
- Glass bookcase or showcase with mirrored base and adjustable feet. Optional drawers.
- Bücherregal oder Regal aus Glas mit verspiegeltem Boden und regelbaren Füßen. Optionale Schubladen.
- Bibliothèque ou présentoir en verre avec base en miroir e pieds réglables. Tiroirs optionnels.

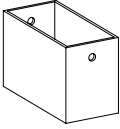
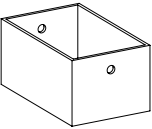
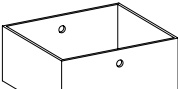
	I	dimensioni	spessore	volume	carico ammesso	peso	prezzo
	E	dimension	thickness	volume	admitted load	weight	price
	D	abmessungen	stärke	volumen	tragfähigkeit	gewicht	preis
	F	dimension	épaisseur	volume	charge admise	poids	prix
		cm	mm	m3	kg	kg	euro
Liber cassetto design Luca Papini 2013/2022   		C1 19 x 40 x h 25		0,03	15	2,5	● 290 ●● 300 ●●● 340 ●●●● 460
		C2 25 x 40 x h 19		0,03	15	2,5	● 290 ●● 300 ●●● 340 ●●●● 460
		C3 45 x 40 x h 19		0,06	15	4,5	● 330 ●● 340 ●●● 360 ●●●● 490

- Cassetto in legno laccato in finitura bianco opaco con foro bifacciale.
- Drawer in matt white lacquered wood with double sided opening.
- Schublade aus Holz matt weiß lackiert mit beidseitiger Öffnung.
- Tiroir en bois laqué mat blanc avec trou biface.

- Cassetto in legno laccato in finitura RAL opaco con foro bifacciale
- Drawer in matt RAL lacquered wood with double sided opening.
- Schublade aus Holz matt RAL lackiert mit beidseitiger Öffnung.
- Tiroir en bois laqué mat RAL avec trou biface.

- Cassetto in legno SIBERIAN ASH, EUCALIPTO e Noce Canaletto con maniglia in pelle.
- Wooden drawer in SIBERIAN ASH, EUCALIPTO and Canaletto Walnut with leather knob.
- Holzschublade aus SIBERIAN ASH, EUCALIPTO und Canaletto Walnuß mit Ledergriff.
- Tiroir en bois SIBERIAN ASH, EUCALIPTO et Noyer Canaletto avec pommeau en cuir.

- Cassetto in cuoio testa di moro con una maniglia.
- Drawer in dark leather with one handle.
- Schublade aus dunklem Leder mit einem Griff.
- Tiroir en cuir Tête-De-Maure avec un pommeau.

	I E D F	dimensioni dimension abmessungen dimension	spessore thickness stärke épaisseur	volume volume volumen volume	carico ammesso admitted load tragfähigkeit charge admise	peso weight gewicht poids	prezzo price preis prix
		cm	mm	m3	kg	kg	euro
Liber 100 design Luca Papini 2022	SX	100 x 39 x h 200	10 / 12	1,32	15 *	159	<input type="checkbox"/> 3.790 <input checked="" type="checkbox"/> 3.950 <input checked="" type="checkbox"/> 4.340
	DX	100 x 39 x h 200	10 / 12	1,32	15 *	159	<input type="checkbox"/> 3.790 <input checked="" type="checkbox"/> 3.950 <input checked="" type="checkbox"/> 4.340
	SX	100 x 39 x h 240	10 / 12	1,58	15 *	191	<input type="checkbox"/> 4.610 <input checked="" type="checkbox"/> 4.780 <input checked="" type="checkbox"/> 5.260
	DX	100 x 39 x h 240	10 / 12	1,58	15 *	191	<input type="checkbox"/> 4.610 <input checked="" type="checkbox"/> 4.780 <input checked="" type="checkbox"/> 5.260

H 200 SX

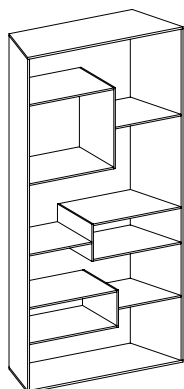

H 200 DX

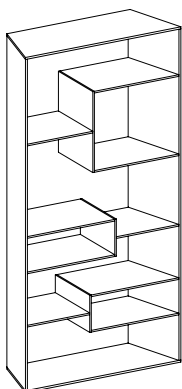

H 240 SX

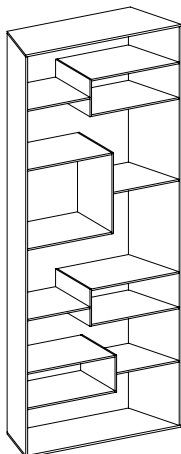

H 240 DX

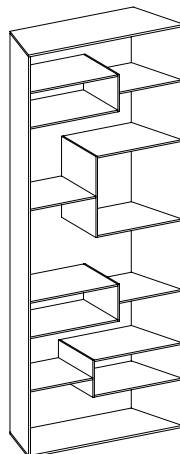

Optional CONTENITORE ANTA BATTENTE con maniglia in pelle
optional HINGE DOOR STORAGE UNIT with leather handle
optional DREHFLÜGELTÜR ELEMENT mit Ledergriff
optionel RECIPIENT PORTE A BATTANT avec poignée en cuir

* ogni ripiano / on each shelf / auf jedem Bord / pour chaque étagère

- Vetro extrachiaro / extra clear glass / extrahelles Glas / verre extra clair
- Vetro fumé / smoked glass / Rauchglas / verre fumé
- Vetro bronzo / bronze glass / Bronze Glas / Verre bronze

Specificare sempre se versione SX o DX
Always specify left or right version
Immer Version links oder rechts angeben
Toujours spécifier version gauche ou droite

- Libreria o espositore in vetro extra chiaro, fumé o bronzo con base a specchio e piedini regolabili. I fianchi inclinati permettono di realizzare composizioni curvilinee o lineari. Attrezzabile con contenitore in legno anta battente.
- Bookcase or showcase in extra clear, smoked or bronze glass with mirrored base and adjustable feet.
- The inclined sides allow to create curvilinear or linear compositions. It can be equipped with wooden storage unit with hinge door.
- Bücherregal oder Regal aus extrahellem Glas, Rauchglas oder Bronze Glas mit verspiegeltem Boden und regulierbaren Füßen. Die schrägen Seiten erlauben sowohl krummlinige sowie lineare Kompositionen herzustellen. Es kann mit Holzelement mit Drehflügeltür ausgestattet werden.
- Bibliothèque ou présentoir en verre extra clair, fumé ou bronze base en miroir et pieds réglables. Le cotés inclinés permettent de réaliser des compositions curvilignes ou linéaires. Il peut être équipé avec récipient en bois avec porte a battant.

	I	dimensioni	spessore	volume	carico ammesso	peso	prezzo
	E	dimension	thickness	volume	admitted load	weight	price
	D	abmessungen	stärke	volumen	tragfähigkeit	gewicht	preis
	F	dimension	épaisseur	volume	charge admise	poids	prix
		cm	mm	m3	kg	kg	euro
Liber 100 Optional design Luca Papini 2022	LOC	54x39xh46		0,18		16	880
	LOL	54x39xh46		0,18		16	890

LOC

anta lato corto / door short side / Tür kurze Seite / porte coté court

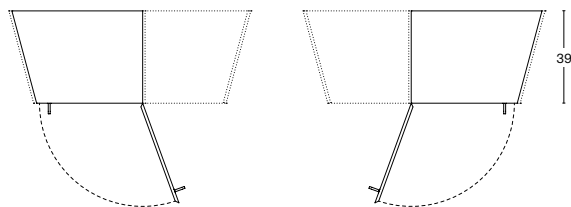
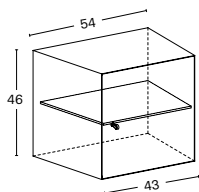

LOL

Anta lato lungo / door long side / Tür lange Seite / porte coté long

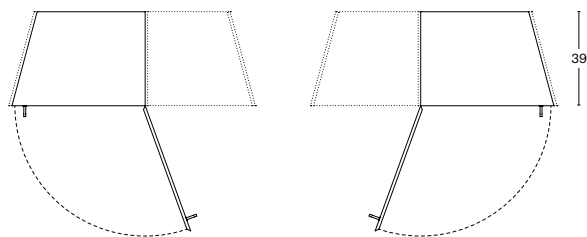
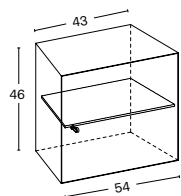

CONTENITORE ANTA BATTENTE
HINGE DOOR STORAGE UNIT
DREHFLÜGELTÜR ELEMENT
RECIPIENT PORTE A BATTANT

Specificare la finitura in legno SIBERIAN ASH o EUCALIPTO
Always specify wood finish SIBERIAN ASH o EUCALIPTO
Immer Holzausführung angeben SIBERIAN ASH oder EUCALIPTO
Toujours spécifier finition bois SIBERIAN ASH ou EUCALIPTO

- Contenitore in legno SIBERIAN ASH o EUCALIPTO con anta battente a chiusura ammortizzata e maniglia in pelle. Ripiano interno in vetro extra chiaro.
- Storage unit in wood SIBERIAN ASH or EUCALIPTO with soft closure hinge door and leather handle. Extra clear glass internal shelf.
- Holzelement aus SIBERIAN ASH oder EUCALIPTO mit Drehflügeltür mit gedämpfter Schließung und Ledergriff. Inneres Fach aus extrahellem Glas.
- Récipient en bois SIBERIAN ASH ou EUCALIPTO avec porte à battante avec fermeture amortie et poignée en cuir. Etagère intérieur en verre extra clair.

	I E D F	dimensioni dimension abmessungen dimension	spessore thickness stärke épaisseur	volume volume volumen volume	carico ammesso admitted load tragfähigkeit charge admise	peso weight gewicht poids	prezzo price preis prix
		cm	mm	m3	kg	kg	euro

Liber 60 design Luca Papini 2022	SX	60x39xh 200	10 / 12	0,81	15 *	121	<input type="checkbox"/> 3.370 <input checked="" type="checkbox"/> 3.490 <input type="checkbox"/> 3.750
	DX	60x39xh 200	10 / 12	0,81	15 *	121	<input type="checkbox"/> 3.370 <input checked="" type="checkbox"/> 3.490 <input type="checkbox"/> 3.750
	SX	60x39xh 240	10 / 12	0,97	15 *	173	<input type="checkbox"/> 3.940 <input checked="" type="checkbox"/> 4.130 <input type="checkbox"/> 4.540
	DX	60x39xh 240	10 / 12	0,97	15 *	173	<input type="checkbox"/> 3.940 <input checked="" type="checkbox"/> 4.130 <input type="checkbox"/> 4.540

H 200 SX

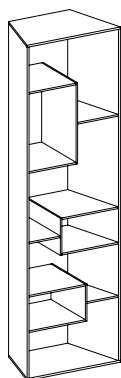

H 200 DX

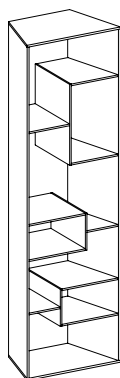

H 240 SX

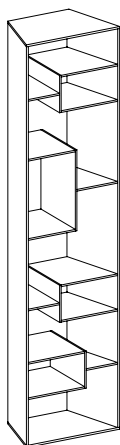

H 240 DX

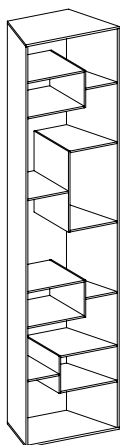

* ogni ripiano / on each shelf / auf jedem Bord / pour chaque étagère

- Vetro extrachiaro / extra clear glass / extrahelles Glas / verre extra clair
- Vetro fumé / smoked glass / Rauchglas / verre fumé
- Vetro bronzo / bronze glass / Bronze Glas / Verre bronze

Specificare sempre se versione SX o DX
Always specify left or right version
Immer Version links oder rechts angeben
Toujours spécifier version gauche ou droite

- Libreria o espositore in vetro extra chiaro, fumé o bronzo con base a specchio e piedini regolabili. I fianchi inclinati permettono di realizzare composizioni curvilinee o lineari.
- Bookcase or showcase in extra clear, smoked or bronze glass with mirrored base and adjustable feet. The inclined sides allow to create curvilinear or linear compositions.
- Bücherregal oder Regal aus extrahellem Glas, Rauchglas oder Bronze Glas mit verspiegeltem Boden und regulierbaren Füßen. Die schrägen Seiten erlauben sowohl krummlinige sowie lineare Kompositionen herzustellen.
- Bibliothèque ou présentoir en verre extra clair, fumé ou bronze base en miroir et pieds réglables. Le cotés inclinés permettent de réaliser des compositions curvilignes ou linéaires.

Esempi di composizioni / Composition examples
Kompositionbeispiele / Exemples de composition

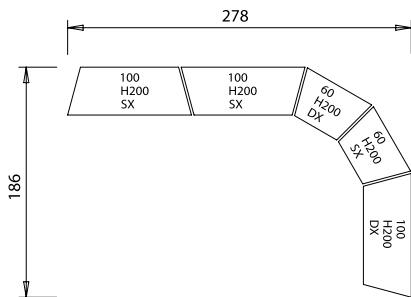
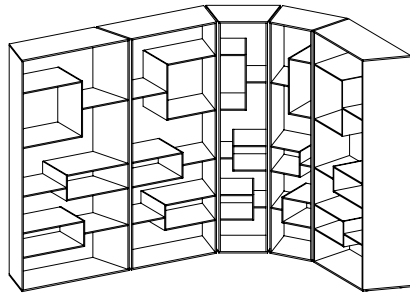

Comp. 1

278 x 186 x h 200
2 x 100 h 200 sx + 1 x 100 h 200 dx
1 x 60 h 200 dx + 1 x 60 h 200 sx

tot. □ 18.110
tot. ■ 18.830
tot. ■ 20.520

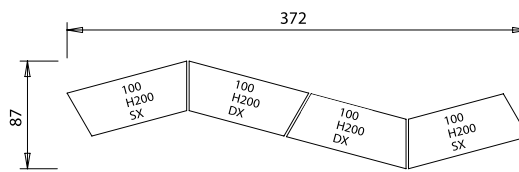
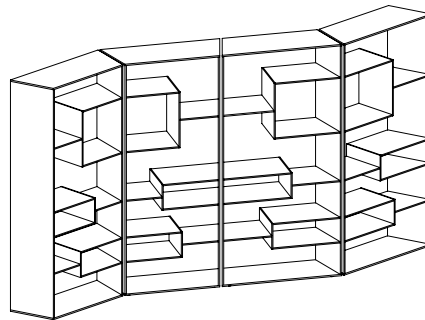

Comp. 2

372 x 87 x h 200
2 x 100 h 200 sx + 2 x 100 h 200 dx

tot. □ 15.160
tot. ■ 15.800
tot. ■ 17.360

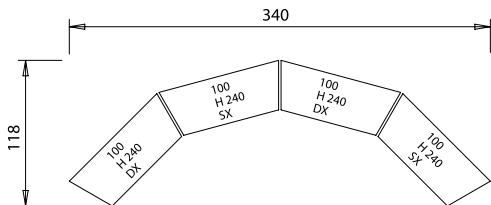
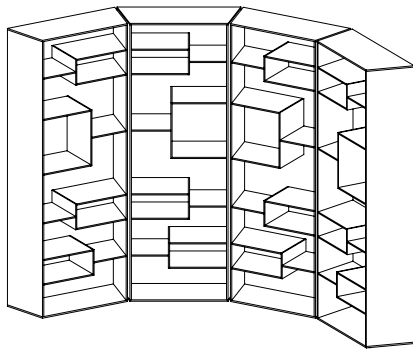

Comp. 3

340 x 118 x h 240
2 x 100 h 240 dx + 2 x 100 h 240 sx

tot. □ 18.440
tot. ■ 19.120
tot. ■ 21.040

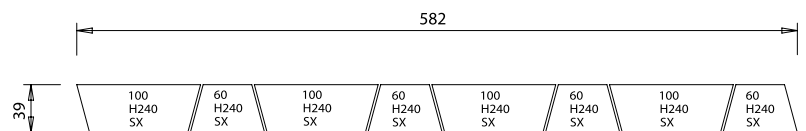
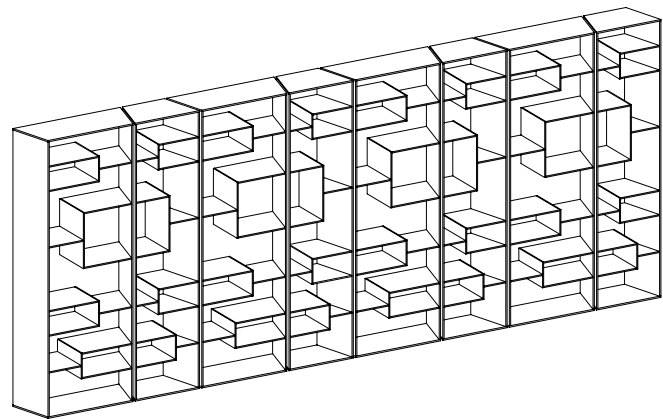

Comp. 4

582 x 39 x h 240
4 x 100 h 240 sx + 4 x 60 h 240 sx

tot. □ 34.200
tot. ■ 35.640
tot. ■ 39.200

- Vetro extrachiaro / extra clear glass / extrahelles Glas / verre extra clair
- Vetro fumé / smoked glass / Rauchglas / verre fumé
- Vetro bronzo / bronze glass / Bronze Glas / Verre bronze

Modularità e dimensioni versione a parete / Modularity and dimensions wall version
 Modularität und Abmessungen Wandversion/ Modularité et dimensions version au mur

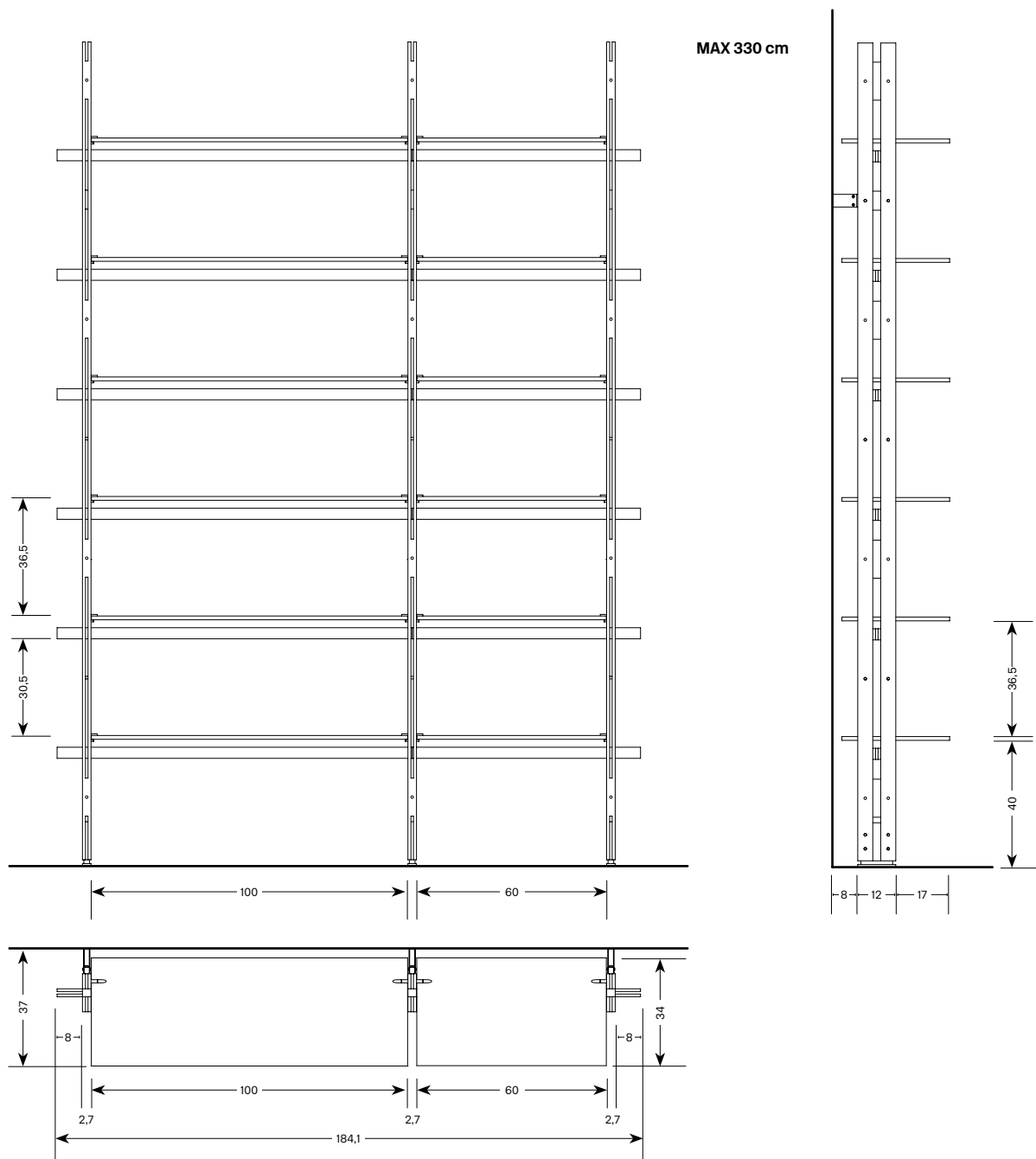

- Per il calcolo della lunghezza totale della libreria, sommare i moduli scelti (60 o 100 cm), più un montante tra un modulo e l'altro (2,7 cm), più due montanti esterni (2,7 cm cadauno), più 2 terminali esterni (8 cm cadauno).
- To calculate total length of the bookcase, add the choosen modules (60 or 100 cm), plus one upright between the modules (2,7 cm) and 2 external uprights (2,7 cm each), plus 2 external terminals (8 cm each).
- Für die Berechnung der Gesamtlänge des Bücherregal, die ausgewählten Module (60 oder 100 cm), mit einem Pfosten zwischen den Modulen (2,7 cm) plus 2 Endpfosten (je 2,7 cm) plus 2 Terminalteile (je 8 cm) addieren.
- Pour calculer la longueur totale de la bibliothèque, additionner les modules choisis (60 ou 100 cm), avec un montant entre les modules (2,7 cm) et 2 montants extérieurs (2,7 cm chaque) et 2 éléments terminaux (8 cm chaque).

- I tasselli di fissaggio in dotazione possono dimostrarsi inappropriati in alcune situazioni. La qualità dell'operazione di montaggio è di esclusiva responsabilità del cliente che dovrà utilizzare i materiali di fissaggio più idonei alle caratteristiche strutturali del soffitto, della parete e del pavimento.
- The screw anchors that are included might appear unsuitable in certain situations. The quality of the assembly is under complete responsibility of the client, who will have to use the fixing materials best suited for the structural characteristics of the ceiling, wall and floor.
- Die gelieferten Befestigungsdübel können in bestimmten Situationen als ungeeignet erscheinen. Die Qualität der Montage ist exklusive Verantwortung des Kunden, der für die strukturellen Eigenschaften von Decke, Wand und Boden, die am besten geeigneten Befestigungsmaterialien benutzen muss.
- Les chevilles de fixation fournies peuvent résulter inapproprié dans certaines situations. La qualité de l'opération de montage est responsabilité exclusive du client, qui devra utiliser les matériaux de fixations les plus indiqués aux attributs du plafond, du mur et du sol.

Modularità e dimensioni versione a soffitto / Modularity and dimensions ceiling version
 Modularität und Abmessungen Deckenversion / Modularité et dimensions version au plafond

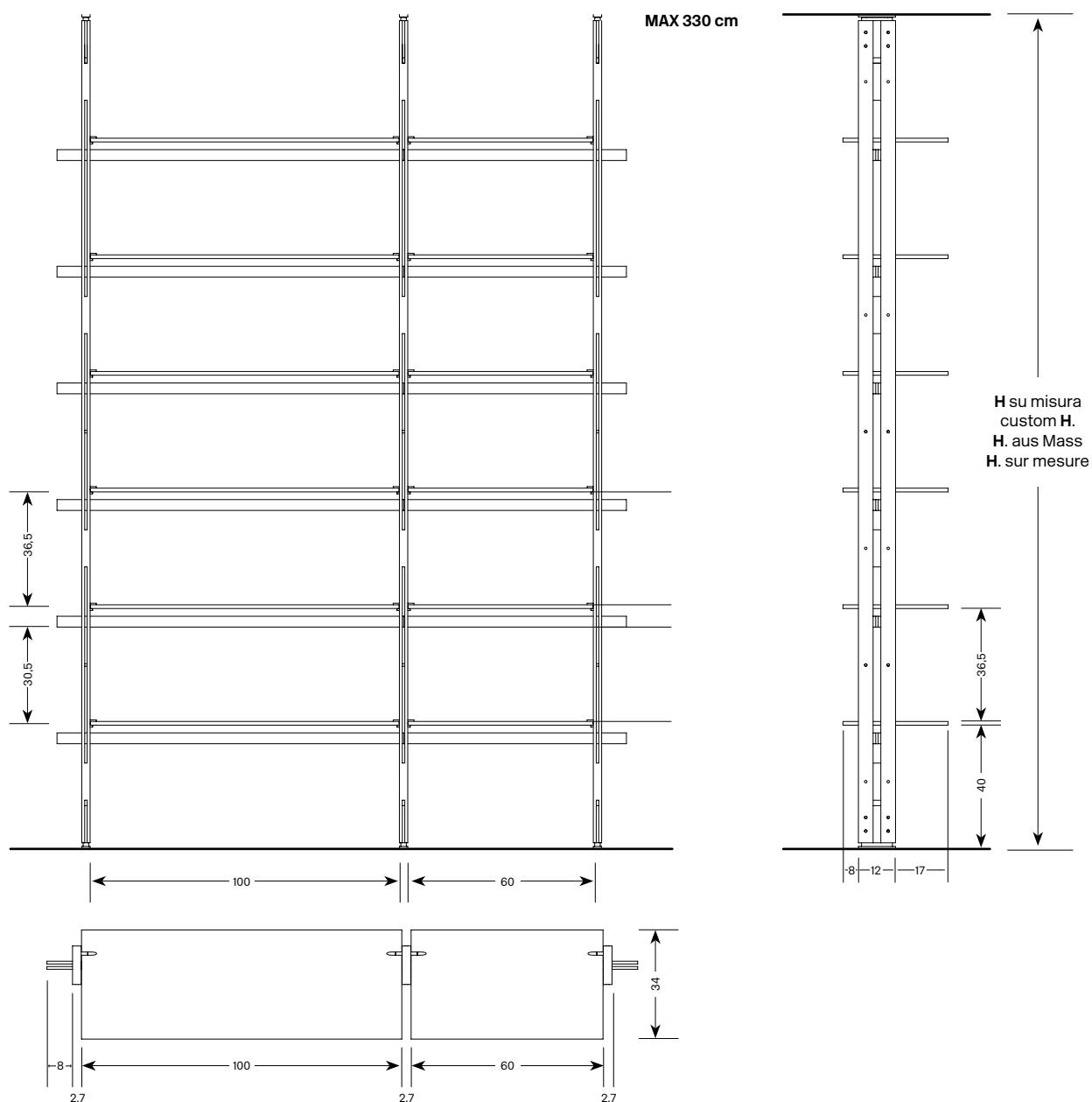

- Per il calcolo della lunghezza totale della libreria, sommare i moduli scelti (60 o 100 cm), più un montante tra un modulo e l'altro (2,7 cm), più due montanti esterni (2,7 cm cadauno), più 2 terminali esterni (8 cm cadauno).
- To calculate total length of the bookcase, add the chosen modules (60 or 100 cm), plus one upright between the modules (2,7 cm) and 2 external uprights (2,7 cm each), plus 2 external terminals (8 cm each).
- Für die Berechnung der Gesamtlänge des Bücherregal, die ausgewählten Module (60 oder 100 cm), mit einem Pfosten zwischen den Modulen (2,7 cm) plus 2 Endpfosten (je 2,7 cm) plus 2 Terminalteile (je 8 cm) addieren.
- Pour calculer la longueur totale de la bibliothèque, additionner les modules choisis (60 ou 100 cm), avec un montant entre les modules (2,7 cm) et 2 montants extérieurs (2,7 cm chaque) et 2 éléments terminaux (8 cm chaque).

- I tasselli di fissaggio in dotazione possono dimostrarsi inadatti in alcune situazioni. La qualità dell'operazione di montaggio è di esclusiva responsabilità del cliente che dovrà utilizzare i materiali di fissaggio più idonei alle caratteristiche strutturali del soffitto, della parete e del pavimento.
- The screw anchors that are included might appear unsuitable in certain situations. The quality of the assembly is under complete responsibility of the client, who will have to use the fixing materials best suited for the structural characteristics of the ceiling, wall and floor.
- Die gelieferten Befestigungsdübel können in bestimmten Situationen als ungeeignet erscheinen. Die Qualität der Montage ist exklusive Verantwortung des Kunden, der für die strukturellen Eigenschaften von Decke, Wand und Boden, die am besten geeigneten Befestigungsmaterialien benutzen muss.
- Les chevilles de fixation fournies peuvent résulter inapproprié dans certaines situations. La qualité de l'opération de montage est responsabilité exclusive du client, qui devra utiliser les matériaux de fixations les plus indiqués aux attributs du plafond, du mur et du sol.

Specifiche tecniche accessori / accessories' technical specifications
 Technische Angaben der Zubehöre / Spécifications techniques des accessoires

CONTENITORI ORIZZONTALI / HORIZONTAL STORAGE UNITS / HORIZONTAL ELEMENTE / RECIPIENTS HORIZONTEAUX

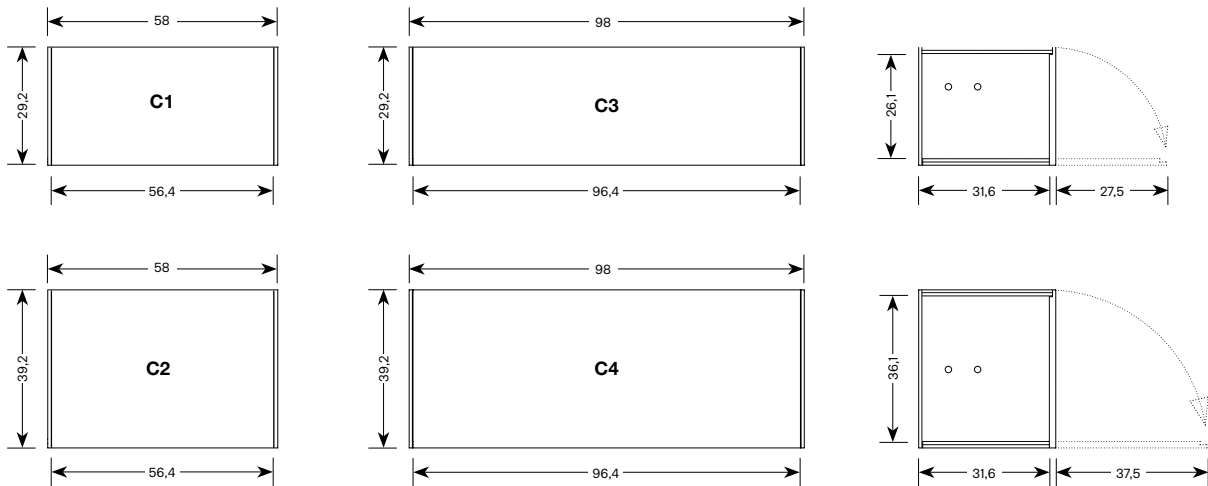

CONTENITORI VERTICALI / VERTICAL STORAGE UNITS / SENKRECHTE ELEMENTE / RECIPIENTS VERTICALES

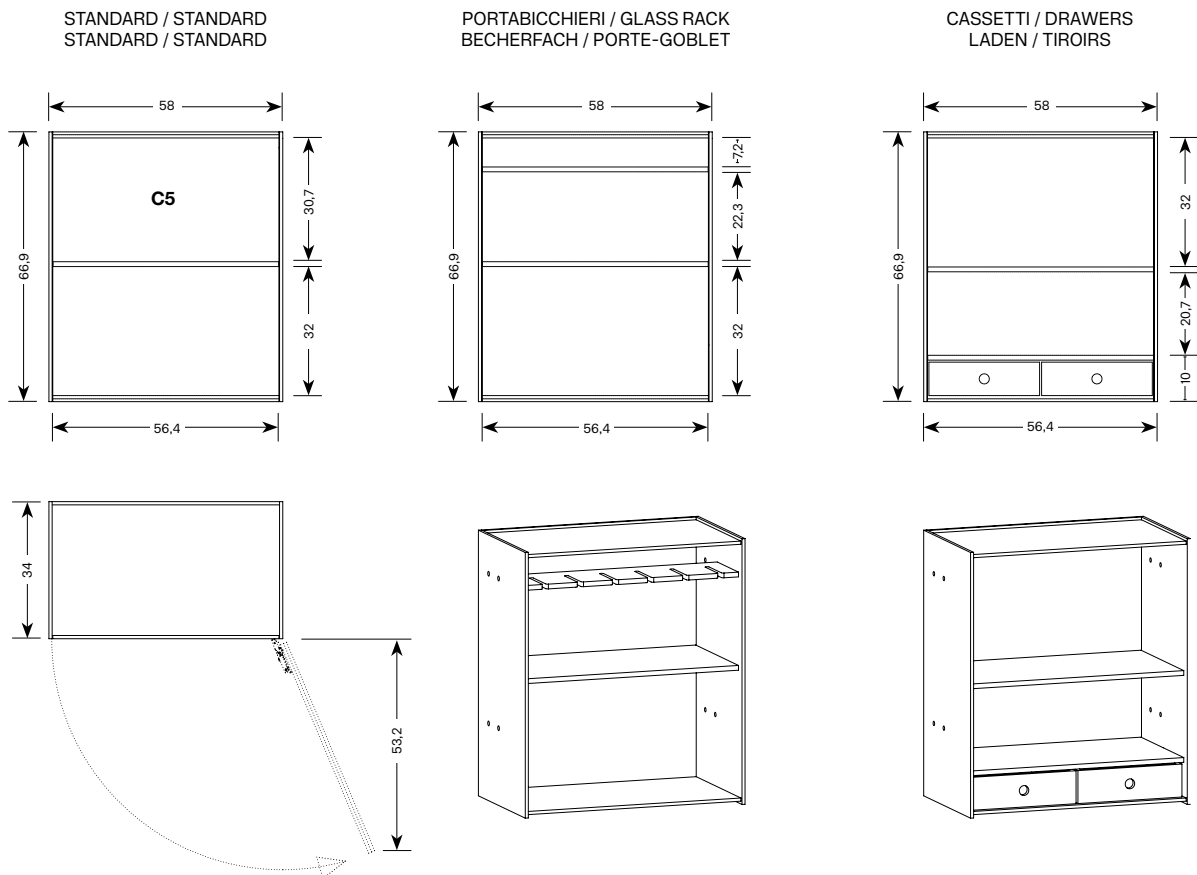

Specifiche tecniche accessori / accessories' technical specifications
Technische Angaben der Zubehöre / Spécifications techniques des accessoires

MODULO TV / TV MODULE / TV MODUL / MODULE TV

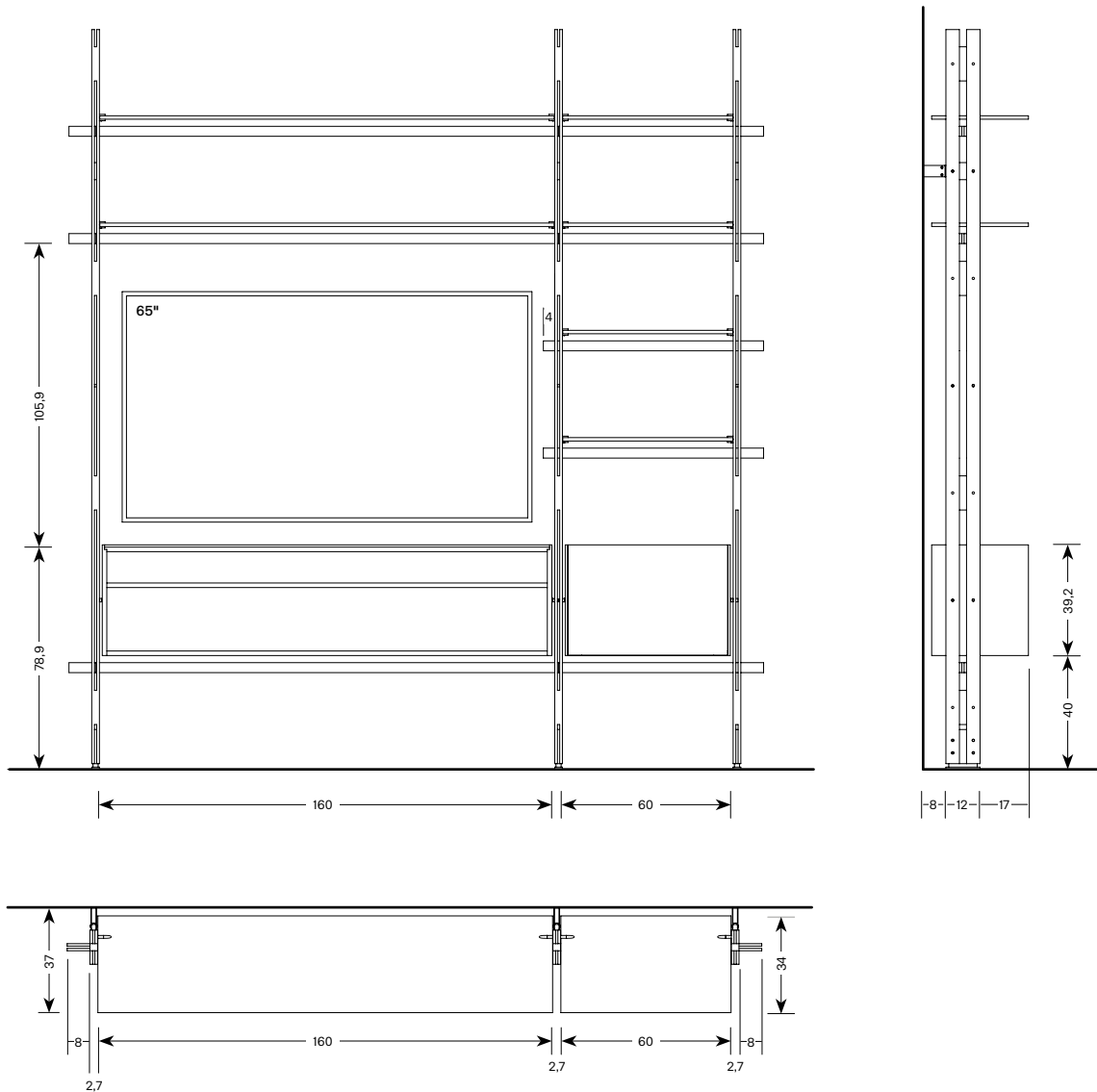

CONTENITORE ORIZZONTALE MODULO TV / HORIZONTAL TV STORAGE UNIT HORIZONTAL TV ELEMENT / RECIPIENT HORIZONTAL MODULE TV

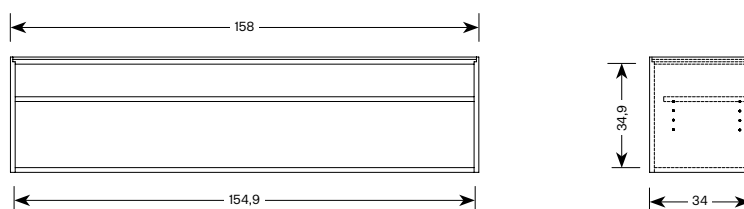

	I	dimensioni	spessore	volume	carico ammesso	peso	prezzo
	E	dimension	thickness	volume	admitted load	weight	price
	D	abmessungen	stärke	volumen	tragfähigkeit	gewicht	preis
	F	dimension	épaisseur	volume	charge admise	poids	prix
		cm	mm	m3	kg	kg	euro

Hemingway

design Massimo Castagna 2020

M2 12x2,7 x h 260		0,043		12	1.390
--------------------------	--	-------	--	----	--------------

Può accogliere al massimo nr. 6 ripiani / can accomodate maximum 6 shelves
kann maximal 6 Böden aufnehmen / peut acceullir maximum 6 étagères

Versione a parete
Wall version
Wandversion
Version au mur

M1 12x2,7 x h 300		0,049		14	1.520
--------------------------	--	-------	--	----	--------------

Può accogliere al massimo nr. 7 ripiani / can accomodate maximum 7 shelves
kann maximal 7 Böden aufnehmen / peut acceullir maximum 7 étagères

MONTANTI / UPRIGHTS
PFOSTEN / MONTANTS

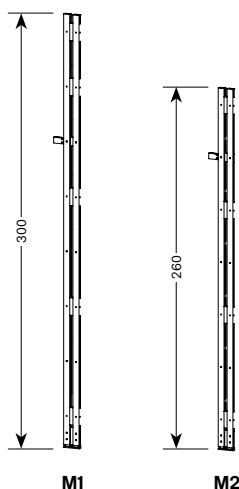

Specificare la finitura in legno del montante SIBERIAN ASH oppure EUCALIPTO
Specify wood finish of upright SIBERIAN ASH or EUCALIPTO
Holz Ausführung der Pfosten angeben SIBERIAN ASH oder EUCALIPTO
Indiquer finition bois du montant SIBERIAN ASH ou EUCALIPTO

Specificare la finitura in metallo degli inserti CROMO LUCIDO oppure ORO LUCIDO
Specify metal finish of inserts POLISHED CHROME or POLISHED GOLD finish
Metallausführung der Einsätze angeben CHROM GLÄNZEND oder GOLD GLÄNZEND
Indiquer finition inserts en métal CHROME BRILLANT ou OR BRILLANT

Staffa di fissaggio a parete e piede regolabile sempre inclusi nel montante
Wall fixing bracket and adjustable foot always included in the upright
Pfosten immer inklusiver Wandhalterung und regulierbarem Fuß
Support de fixation au mur et pied réglable toujours inclus avec le montant

Montanti disponibili su misura da un'altezza minima di cm 137 ad una massima di cm 330. Per i prezzi vedere tabella. Per composizioni di altezza non compresa fra queste misure, richiedere fattibilità e preventivo al ns. ufficio vendite

Uprights available in custom size from minimum 137cm to maximum 330cm. For pricing see schedule. For compositions of heights not included in these measures, ask our sales department for feasibility and pricing.

Pfosten auf Maß verfügbar von mindestens 137cm bis maximal 330cm. Siehe Tabelle für die Preise. Für Kompositionen in Höhe die nicht in diesen Maßen aufgeführt sind, wenden Sie sich bitte an unser Verkaufsbüro um Machbarkeit und Preise anzufragen.

Montants disponibles sur mesure de minimum 137cm à maximum 330cm. Pour les prix voir tableau. Pour compositions d'hauteur pas inclus dans ces mesures, demander faisabilité et prix à notre bureau de ventes.

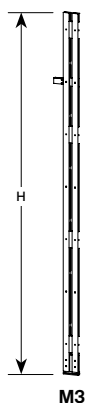

H / M3	nr. max di ripiani maximum number of shelves maximale Bödennummer numéro maximum d'étagères	
cm 137 - 174	3	1.460
cm 175 - 212	4	1.530
cm 213 - 250	5	1.590
cm 251 - 288	6	1.660
cm 289 - 330	7	1.740

- Libreria modulare con fissaggio a parete. Montanti verticali e traversi orizzontali in legno massello finitura Siberian Ash o Eucalipto, con inserti metallo cromo lucido o oro lucido. Ripiani in vetro extrachiaro o fumè. Piedi regolabili in altezza +2 cm. Attrezzabile con contenitori di diverse dimensioni e utilizzi, oppure scrittoio home office.
- Modular bookcase with wall fixing. Vertical uprights and horizontal beams in solid wood Siberian Ash or Eucalipto finish, with inserts in metal polished chrome or polished gold. Shelves in extra clear or smoked glass. Feet adjustable in height +2 cm. Can be fitted with storage units of different dimensions and usage, or home office desk.
- Modulares Bücherregal mit Wandbefestigung. Senkrechte Pfosten und waagrechte Balken aus Massivholz Siberian Ash oder Eucalipto, mit Metalleinsätze in Chrom glänzend oder Gold glänzend. Böden aus extrahellem Glas oder Rauchglas. Höhenregulierbare Füße +2 cm. Kann mit Schränkchen aus verschiedenen Maßen und Gebrauch ausgestattet werden, oder mit Home Office.
- Bibliothèque modulaire avec fixation au mur. Montants verticales et travers horizontal en bois massif Siberian Ash ou Eucalipto, avec inserts en métal chrome brillant et or brillant. Étagères en verre extra clair ou fumé. Pieds réglables en hauteur + 2 cm. Peut être équipé avec des récipient en mesure et usage différent, ou avec bureau.

	I	dimensioni	spessore	volume	carico ammesso	peso	prezzo
	E	dimension	thickness	volume	admitted load	weight	price
	D	abmessungen	stärke	volumen	tragfähigkeit	gewicht	preis
	F	dimension	épaisseur	volume	charge admise	poids	prix
		cm	mm	m3	kg	kg	euro

Hemingway

design Massimo Castagna 2020

Versione a soffitto

Ceiling mounted version

Version mit Deckenbefestigung

Version au plafond

MONTANTI / UPRIGHTS

PFOSTEN / MONTANTS

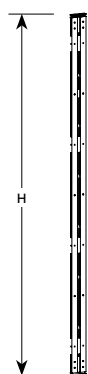

M4

La libreria, con fissaggio a soffitto, viene sempre fornita con montanti su misura, da un'altezza minima di cm 222 ad una massima di cm 330. Per i prezzi vedere tabella. Per composizioni di altezza non compresa fra queste misure, richiedere fattibilità e preventivo al ns. ufficio vendite.

The bookcase with ceiling fixing is always supplied with custom uprights, from a minimum of 222 cm height to maximum 330 cm. For pricing see schedule. For compositions of heights not included in these measures, ask our sales department for feasibility and pricing.

Das Bücherregal mit Deckenbefestigung wird immer mit Pfosten auf Maß geliefert, von einer Höhe von mindestens 222 cm bis maximal 330 cm. Siehe Tabelle für Preise. Für Kompositionen in Höhe die nicht in diesen Maßen aufgeführt sind, wenden Sie sich bitte an unser Verkaufsbüro um Machbarkeit und Preise anzufragen.

La bibliothèque avec fixation au plafond est toujours fournie avec montants sur mesure, d'une hauteur de minimum 222 cm à maximum 330 cm. Pour les prix voir tableau. Pour compositions d'hauteur pas inclus dans ces mesures, demander faisabilité et prix à notre bureau de ventes.

H / M4	nr. max di ripiani maximum number of shelves maximale Bödennummer numéro maximum d'étagères	
cm 222 - 259	5	1.750
cm 260 - 297	6	1.820
cm 298 - 330	7	1.900

Comunicare al momento dell'ordine l'altezza utile del soffitto.

Consigliamo di rilevare l'altezza del soffitto in più punti.

When ordering specify height to ceiling.

We recommend to measure the ceiling height in different places.

Bei Bestellung die Deckenhöhe angeben.

Wir empfehlen die Deckenhöhe in verschiedenen Punkten abzumessen.

A la commande indiquer hauteur sous le plafond.

Nous conseillons de mesurer l'hauteur sous le plafond en différents points.

Specificare la finitura in legno del montante SIBERIAN ASH oppure EUCALIPTO

Specify wood finish of upright SIBERIAN ASH or EUCALIPTO

Holzausführung der Pfosten angeben SIBERIAN ASH oder EUCALIPTO

Indiquer finition bois du montant SIBERIAN ASH ou EUCALIPTO

Specificare la finitura in metallo degli inserti CROMO LUCIDO oppure ORO LUCIDO

Specify metal finish of inserts POLISHED CHROME or POLISHED GOLD finish

Metallausführung der Einsätze angeben CHROM GLÄNZEND oder GOLD GLÄNZEND

Indiquer finition inserts en métal CHROME BRILLANT ou OR BRILLANT

Staffa di fissaggio a soffitto regolabile +3cm e piede regolabile +2cm sempre inclusi nel montante

Adjustable ceiling fixing bracket +3cm and adjustable foot +2cm always included in the upright

Pfosten immer inklusiver regulierbarer Deckenhalterung +3cm und regulierbarem Fuß +2cm

Support de fixation au plafond réglable +3cm et pied réglable +2cm toujours inclus avec le montant

- Libreria modulare con fissaggio a soffitto. Montanti verticali e traversi orizzontali in legno massello finitura Siberian Ash o Eucalipto, con inserti metallo cromo lucido o oro lucido. Ripiani in vetro extrachiaro o fumé. Attrezzabile con contenitori di diverse dimensioni e utilizzi, oppure scrittoio home office.
- Modular bookcase with ceiling fixing. Vertical uprights and horizontal beams in solid wood, Siberian Ash or Eucalipto finish, with inserts in metal polished chrome or polished gold. Shelves in extra clear or smoked glass. Can be fitted with storage units of different dimensions and usage, or home office desk.
- Moduliert Bücherregal mit Deckenbefestigung. Senkrechte Pfosten und waagrechte Balken aus Massivholz Siberian Ash oder Eucalipto, mit Metalleinsätze in Chrom glänzend oder Gold glänzend. Böden aus extrahellem Glas oder Rauchglas. Kann mit Schränkchen aus verschiedenen Maßen und Gebrauch ausgestattet werden, oder mit Home Office.
- Bibliothèque modulaire avec fixation au plafond. Montants verticales et travers horizontal en bois massif Siberian Ash ou Eucalipto, avec inserts en métal chrome brillant et or brillant. Étagères en verre extra clair ou fumé. Peut être équipé avec des récipient en mesure et usage différent, ou avec bureau.

	I E D F	dimensioni dimension abmessungen dimension	spessore thickness stärke épaisseur	volume volume volumen volume	carico ammesso admitted load tragfähigkeit charge admise	peso weight gewicht poids	prezzo price preis prix
		cm	mm	m3	kg	kg	euro

Hemingway design Massimo Castagna 2020	R1	60 x 34 x h 7	12	0,02	15	9	330
	R2	100 x 34 x h 7	12	0,033	15	15	350

**RIPIANI E TRAVERSI / SHELVES AND BEAMS
BÖDEN UND BALKEN / ETAGERES ET TRAVERS**



Specificare la finitura del vetro EXTRACHIARO oppure FUME'
Always specify glass finish EXTRA CLEAR or SMOKED
Immer Glasversion angeben EXTRAHELL oder RAUCHGLAS
Indiquer toujours finition verre EXTRA CLAIR ou FUME.

Il ripiano di vetro è sempre abbinato a un traverso di legno, della stessa finitura del montante
Glass shelf is always combined with a wood beam of the same finish as the upright
Glasboden ist immer mit einem Hozbalken, in derselben Ausführung des Pfosten, kombiniert
Etagère en verre toujours combiné avec travers en bois, de la même finition du montant

- Ripiani in vetro extrachiaro o fumè. Fissaggio ad incastro su perni, con sistema di sicurezza anticaduta.
- Shelves in extra clear or smoked glass. Interlocking fixing on pins, with fall arrest security system.
- Böden aus extrahellem Glas oder Rauchglas. Einschnappbefestigung auf Bolzen, mit Sicherungssystem gegen Absturz
- Etagères en verre extra clair ou fumé. Fixage à encastrement sur pivots, avec système de sécurité antichute

Hemingway design Massimo Castagna 2020	S1	100 x 60 x h 7	35	0,247	30	35	1.270
--	----	----------------	----	-------	----	----	-------

**SCRITTOIO / DESK
SCHREIBTISCH / BUREAU**

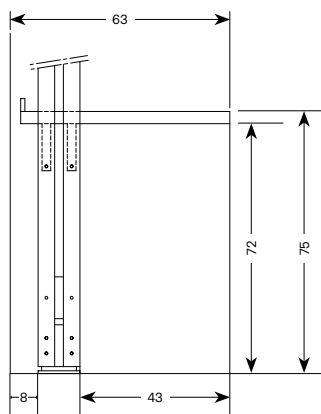
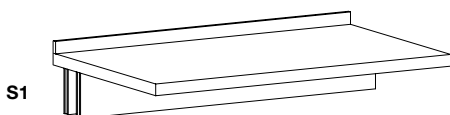

Specificare la finitura del legno SIBERIAN ASH oppure EUCALIPTO
Always specify wood finish SIBERIAN ASH or EUCALIPTO
Immer Holz Ausführung angeben SIBERIAN ASH oder EUCALIPTO
Indiquer toujours finition bois SIBERIAN ASH ou EUCALIPTO

- Scrivitoio in legno, finitura Siberian Ash o Eucalipto. Disponibile passacavi su richiesta.
- Wood desk, Siberian Ash or Eucalipto finish. Available cable entry on request.
- Holzschreibtisch, Ausführung Siberian Ash oder Eucalipto. Nach Anfrage Kabeldurchgang erhältlich.
- Bureau en bois, finition Siberian Ash ou Eucalipto. Disponible passe-câble sur demande.

S2		S2	Optional passacavo quadrato 74mm nero. Il foro passacavo sarà sempre al centro dello scrivitoio, salvo diversa indicazione. Optional square cable entry 74mm black. Cable entry is always in the center of the desk, unless otherwise specified. Optionaler quadratischer Kabeldurchgang 74mm schwarz. Kabeldurchgang ist immer in der Mitte des Schreibtisches, es sei denn anderseits angegeben. Passe-câble optionnel carré 74mm noir. Passe-câble toujours au centre du bureau, sauf indication différent.	120
----	--	----	---	-----

	I	dimensioni	spessore	volume	carico ammesso	peso	prezzo
	E	dimension	thickness	volume	admitted load	weight	price
	D	abmessungen	stärke	volumen	tragfähigkeit	gewicht	preis
	F	dimension	épaisseur	volume	charge admise	poids	prix
		cm	mm	m3	kg	kg	euro

Hemingway design Massimo Castagna 2020	C1	60 x 34 x h 29	8	0,126	15	32	1.720
	C2	60 x 34 x h 39	8	0,165	15	43	1.790
	C3	100 x 34 x h 29	8	0,218	15	37	1.890
	C4	100 x 34 x h 39	8	0,267	15	48	1.990

CONTENITORI A RIBALTA
 FLAP DOOR STORAGE UNIT
 KIPPTÜR ELEMENT
 RECIPIENT PORTE ABATTANT

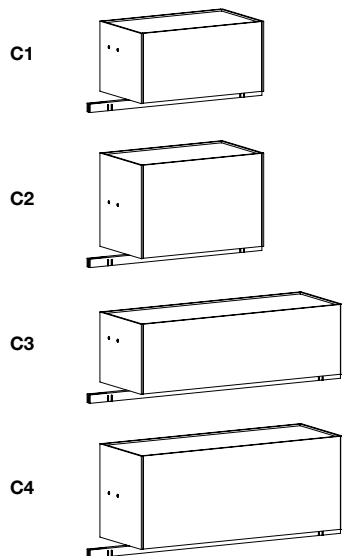

Specificare la finitura di anta e base in legno SIBERIAN ASH oppure EUCALIPTO
Specify wood finish of door and base SIBERIAN ASH or EUCALIPTO
Holz Ausführung der Tür und Bodenplatte angeben SIBERIAN ASH oder EUCALIPTO
Indiquer finition porte et base en bois SIBERIAN ASH ou EUCALIPTO

Il contenitore è sempre abbinato a un traverso in legno, della stessa finitura del montante.
 Storage unit is always combined with a wood beam of the same finish as the upright.
 Element mit Kipptür ist immer mit einem Hozbalken, in derselben Ausführung des Pfosten, kombiniert.
 Récipients toujours combiné avec travers en bois, de la même finition du montant.

- Contenitori orizzontali con anta ribalta verso il basso, con struttura in vetro fumè.
- Anta e base in legno finitura Siberian Ash o Eucalipto.
- Horizontal storage units with flap-down door, structure in smoked glass.
- Door and base in wood Siberian Ash or Eucalipto finish.
- Waagrechte Elemente mit Kipptür, Struktur aus Rauchglas.
- Tür und Bodenplatte aus Holz in Ausführung Siberian Ash oder Eucalipto
- Récipients horizontaux avec porte abattant, structure en verre fumé.
- Porte et base en bois finition Siberian Ash ou Eucalipto.

Hemingway design Massimo Castagna 2020	C5	60 x 34 x h 67	8	0,162	20	46	1.770
--	-----------	----------------	---	-------	----	----	-------

CONTENITORE BATTENTE
 HINGE DOOR STORAGE UNIT
 DREHFLÜGELTÜR ELEMENT
 RECIPIENT PORTE A BATTANT

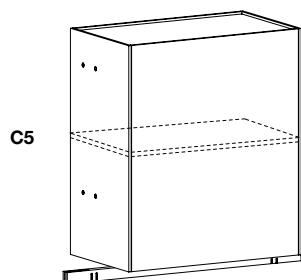

Specificare il verso di apertura dell'anta e la finitura in legno SIBERIAN ASH oppure EUCALIPTO
Always specify door opening and wood finish SIBERIAN ASH or EUCALIPTO
Immer Richtung der Türöffnung angeben und Holz Ausführung SIBERIAN ASH oder EUCALIPTO
Indiquer toujours vers ouverture de la porte et finition du bois SIBERIAN ASH ou EUCALIPTO

Il contenitore è sempre abbinato a un traverso in legno, della stessa finitura del montante.
 Storage unit is always combined with a wood beam of the same finish as the upright.
 Element mit Kipptür ist immer mit einem Hozbalken, in derselben Ausführung des Pfosten, kombiniert.
 Récipients toujours combiné avec travers en bois, de la même finition du montant.

Un ripiano interno in legno incluso / one internal wooden shelf included
 einschließlich ein internes Holzfach / un étagères en bois inclus

Optional portabicchieri in legno / optional wooden glass rack
 optionaler Becherfach aus Holz / porte-gobelet optionnel en bois **240**

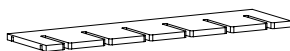

Optional cassetti in legno / optional wood drawers
 Optionale Schubladen aus Holz / tiroirs optionnels en bois **780**

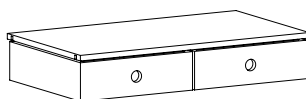

- Contenitore verticale con anta a battente destra o sinistra, con struttura in vetro fumè e anta in legno finitura Siberian Ash o Eucalipto.
- Vertical storage unit with hinged door right or left, with structure in smoked glass and wooden door Siberian Ash or Eucalipto finish.
- Senkrechtes Element mit Drehflügeltür rechts oder links, mit Struktur aus Rauchglas und Holztür in Ausführung Siberian Ash oder Eucalipto.
- Récipient verticale avec porte à battant droite ou gauche, avec structure en verre fumé et porte en bois finition Siberian Ash ou Eucalipto.

	I	dimensioni	spessore	volume	carico ammesso	peso	prezzo
	E	dimension	thickness	volume	admitted load	weight	price
	D	abmessungen	stärke	volumen	tragfähigkeit	gewicht	preis
	F	dimension	épaisseur	volume	charge admise	poids	prix
		cm	mm	m3	kg	kg	euro

Hemingway

R3 160 x 34 x h 7

12

0,068

10

20

550

design Massimo Castagna 2020

RIPIANO E TRAVERSO MODULO TV
SHELVES AND BEAMS TV STORAGE UNIT
BÖDEN UND BALKEN TV ELEMENT
ETAGERES ET TRAVERS MODULE TV

Specificare la finitura del vetro EXTRACHIARO oppure FUME'
Always specify glass finish EXTRA CLEAR or SMOKED
Immer Glasversion angeben EXTRAHELL oder RAUCHGLAS
Indiquer toujours finition verre EXTRA CLAIR ou FUME.

Il ripiano di vetro è sempre abbinato a un traverso di legno, della stessa finitura del montante.
Glass shelf is always combined with a wood beam of the same finish as the upright.
Glasboden ist immer mit einem Hozbalken, in derselben Ausführung des Pfosten, kombiniert.
Etagère en verre toujours combiné avec travers en bois, de la même finition du montant.

R3



- Ripiani in vetro extrachiario o fumè per modulo TV. Fissaggio ad incastro su perni, con sistema di sicurezza anticaduta.
- Shelves in extra clear or smoked glass for TV module. Interlocking fixing on pins, with fall arrest security system.
- Böden aus extrahellem Glas oder Rauchglas für TV Modul. Einschnappbefestigung auf Bolzen, mit Sicherungssystem gegen Absturz.
- Etagères en verre extra clair ou fumé pour module TV. Fixage à encastrement sur pivots, avec système de sécurité antichute.

Hemingway

C6 160 x 34 x h 39

8

0,425

35

36

2.480

design Massimo Castagna 2020

CONTENITORE ORIZZONTALE MODULO TV
HORIZONTAL TV STORAGE UNIT
HORIZONTALES TV ELEMENT
RECIPIENT HORIZONTAL MODULE TV

Specificare la finitura del legno SIBERIAN ASH oppure EUCALIPTO
Always specify wood finish SIBERIAN ASH or EUCALIPTO
Immer Holzausführung angeben SIBERIAN ASH oder EUCALIPTO
Indiquer toujours finition bois SIBERIAN ASH ou EUCALIPTO

Il contenitore è sempre abbinato a un traverso in legno, della stessa finitura del montante.
Storage unit is always combined with a wood beam of the same finish as the upright.
Element ist immer mit einem Hozbalken, in derselben Ausführung des Pfosten, kombiniert.
Récipient toujours combiné avec travers en bois, de la même finition du montant.

Compreso nel prezzo passacavo diametro mm 60 su schienale. Specificare la posizione al momento dell'ordine.
Price includes Ø60mm cable entry on back panel. Always specify position when ordering.
Preis inklusiver Ø60mm Kabeldurchgang auf Rückseite. Bei Bestellung immer Position angeben.
Inclus dans le prix passe-câble Ø60mm sur dos. Spécifier toujours la position au moment de la commande.

C6

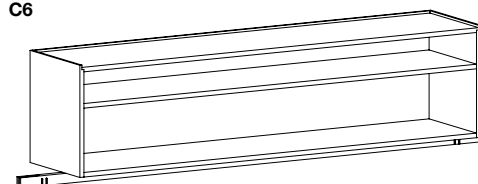

Il ripiano R3 da cm 160 va sempre abbinato al contenitore orizzontale C6 e non può essere utilizzato per uso libreria. È sempre consigliato l'uso di due ripiani in abbinamento al contenitore C6. Per eventuali richieste speciali, rivolgersi al nostro ns. ufficio vendita.

R3 shelf of 160cm must always be combined with the C6 horizontal storage unit and cannot be used alone. We recommend to use two shelves combined with storage unit C6. For possible special requests contact our sales office.

R3 Fach in 160cm wird immer mit dem horizontalen Element C6 kombiniert und kann nicht alleine benutzt werden. Es wird empfohlen immer zwei Fächer in Kombination mit Element C6 zu benutzen. Für Spezialanfragen wenden Sie sich an unser Verkaufsbüro.

Etagères R3 de 160cm va toujours associer au récipient horizontal C6 et ne peut pas être utiliser seul. Il est conseillé d'utiliser toujours deux étagères en combinaison avec le récipient C6. Pour demandes spéciales contacter notre bureau de ventes.

- Contenitore a giorno per composizione TV. Struttura in legno e ripiano regolabile in altezza, finitura Siberian Ash o Eucalipto.
- Open storage unit for TV composition. Structure in wood and height adjustable shelf, finish Siberian Ash or Eucalipto
- Offenes Element für TV-Komposition. Struktur aus Holz und höhenverstellbares Fach Ausführung Siberian Ash oder Eucalipto.
- Récipient ouvert pour composition TV. Structure en bois et étagère réglable en hauteur finition Siberian Ash ou Eucalipto.

S2



S2 Optional passacavo quadrato 74 mm nero.
Optional square cable entry 74 mm black.
Optionaler quadratischer Kabeldurchgang 74 mm schwarz.
Passe-câble optionnel carré 74 mm noir.

120

design Massimo Castagna 2020

Esempi di composizioni / Examples of compositions
Kompositionbeispiele / Examples de composition

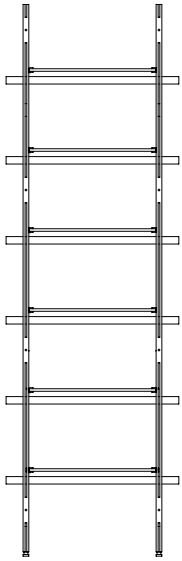

Comp. 201
81,4 x 37 x H 260 cm
2xM2 + 6xR1
tot. 4.760

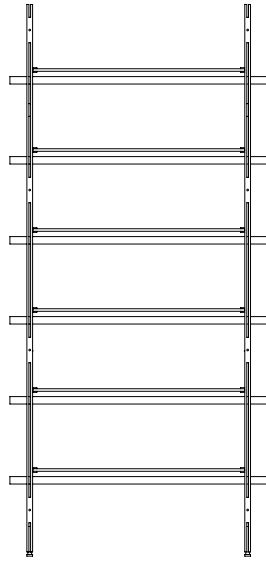

Comp. 203
121,4 x 37 x H 260 cm
2xM2 + 6xR2
tot. 4.880

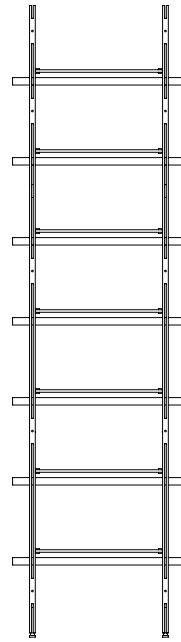

Comp. 205
81,4 x 37 x H 300 cm
2xM1 + 7xR1
tot. 5.350

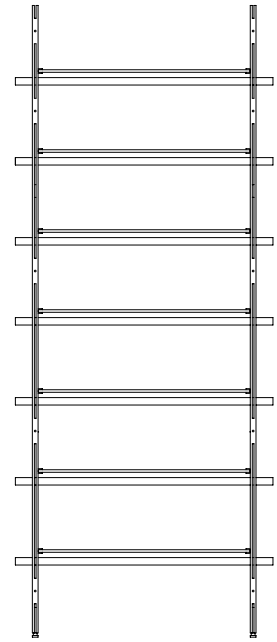

Comp. 207
121,4 x 37 x H.300 cm
2xM1 + 7xR2
tot. 5.490

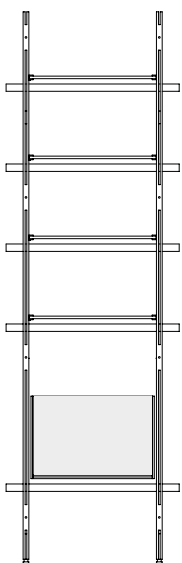

Comp. 209
81,4 x 37 x H 260 cm
2xM2 + 4xR1 + 1C2
tot. 5.890

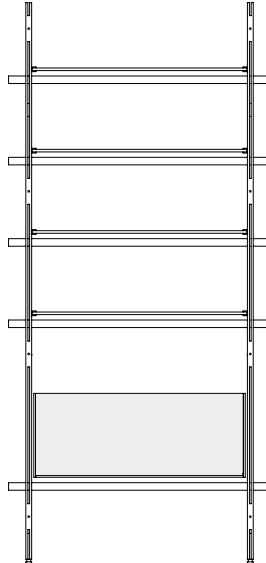

Comp. 211
121,4 x 37 x H 260 cm
2xM2 + 4xR2 + 1C4
tot. 6.170

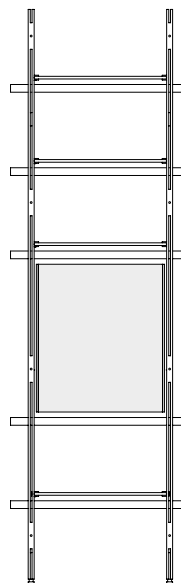

Comp. 213
81,4 x 37 x H 260 cm
2xM2 + 4xR1 + 1C5
tot. 5.870

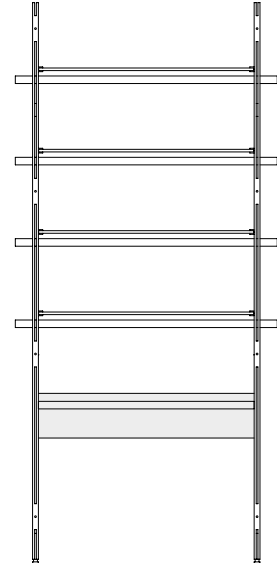

Comp. 215
121,4 x 63 x H 260 cm
2xM2 + 4xR2 + 1S1
tot. 5.450

design Massimo Castagna 2020

Esempi di composizioni / Examples of compositions
Kompositionbeispiele / Exemples de composition

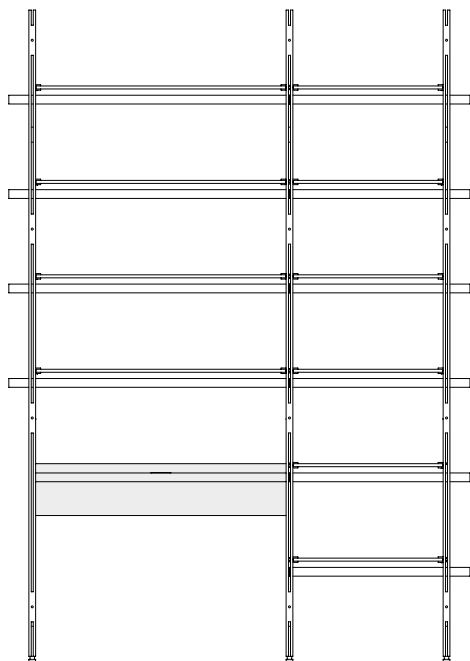

Comp. 303
184,1 x 63 x H 260 cm
3xM2 + 4xR2 + 6xR1 + 1xS1
tot. **8.820**

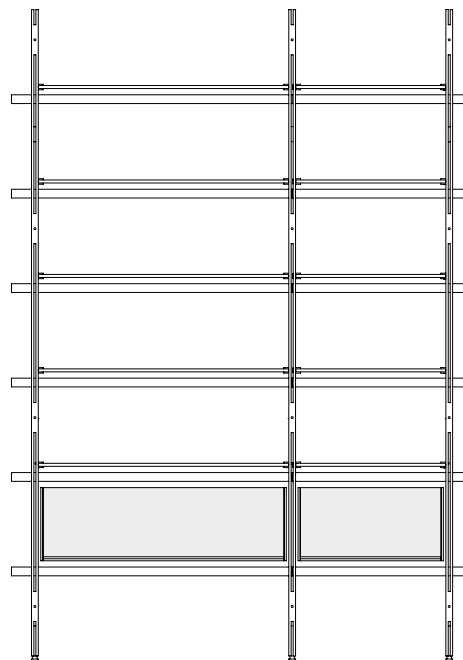

Comp. 305
184,1 x 37 x H 260 cm
3xM2 + 5xR2 + 5xR1 + 1xC3 + 1xC1
tot. **11.180**

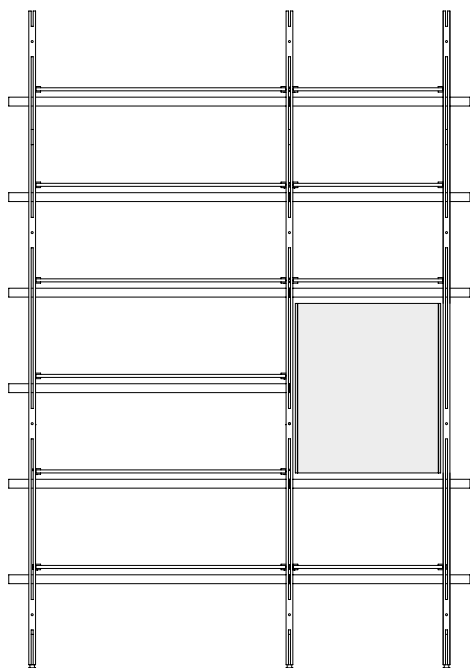

Comp. 307
184,1 x 37 x H 260 cm
3xM2 + 6xR2 + 4xR1 + 1xC5
tot. **9.360**

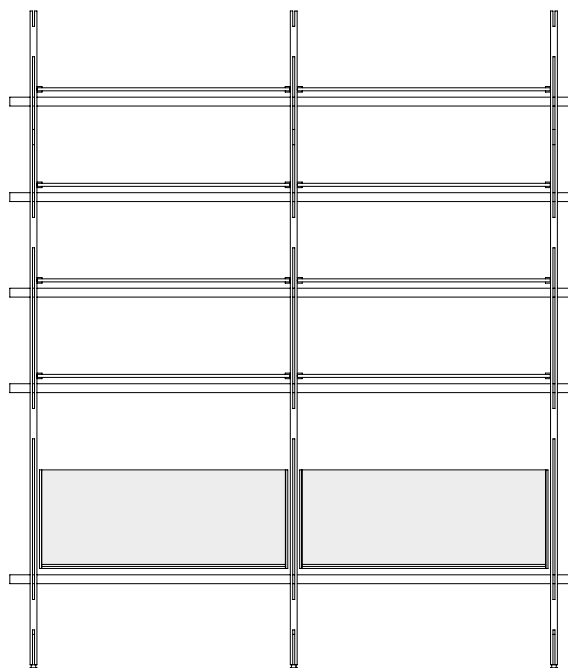

Comp. 311
224,1 x 63 x H 260 cm
3xM2 + 8xR2 + 2xC4
tot. **10.950**

design Massimo Castagna 2020

Esempi di composizioni / Examples of compositions
Kompositionbeispiele / Exemples de composition

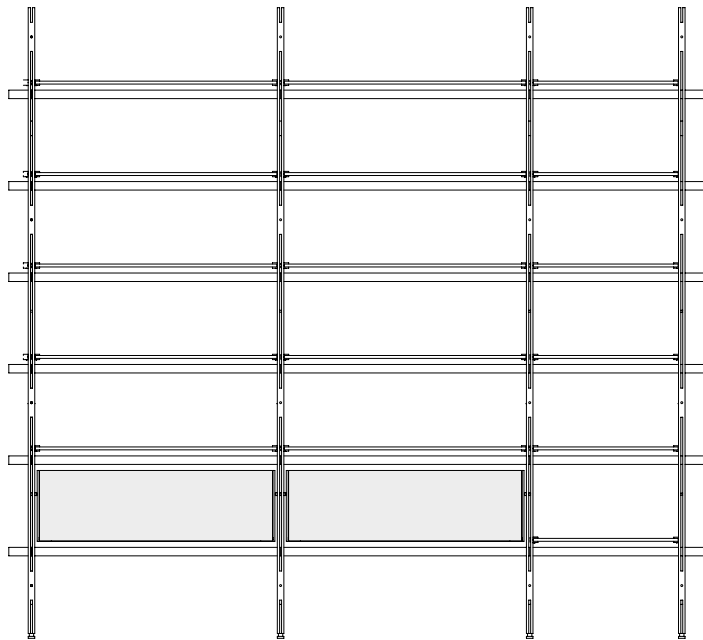

Comp. 401
286,8 x 37 x H 260 cm
4xM2 + 10xR2 + 6xR1 + 2xC3
tot. 14.820

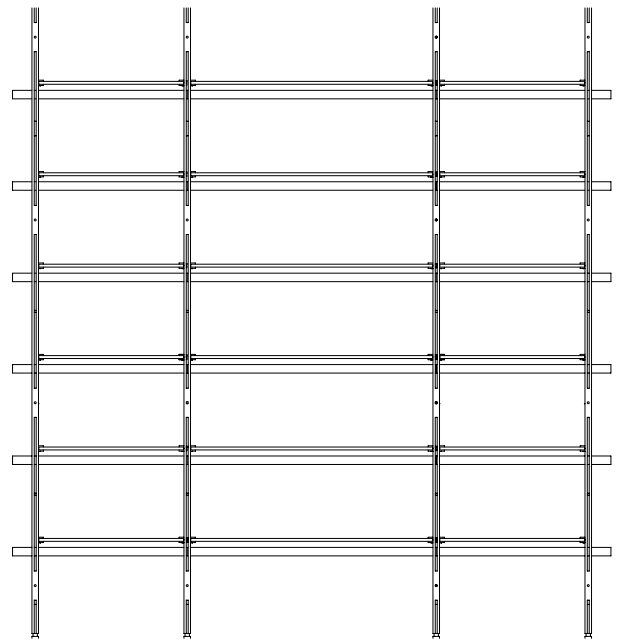

Comp. 403
246,8 x 37 x H 260 cm
4xM2 + 6xR2 + 12xR1
tot. 11.620

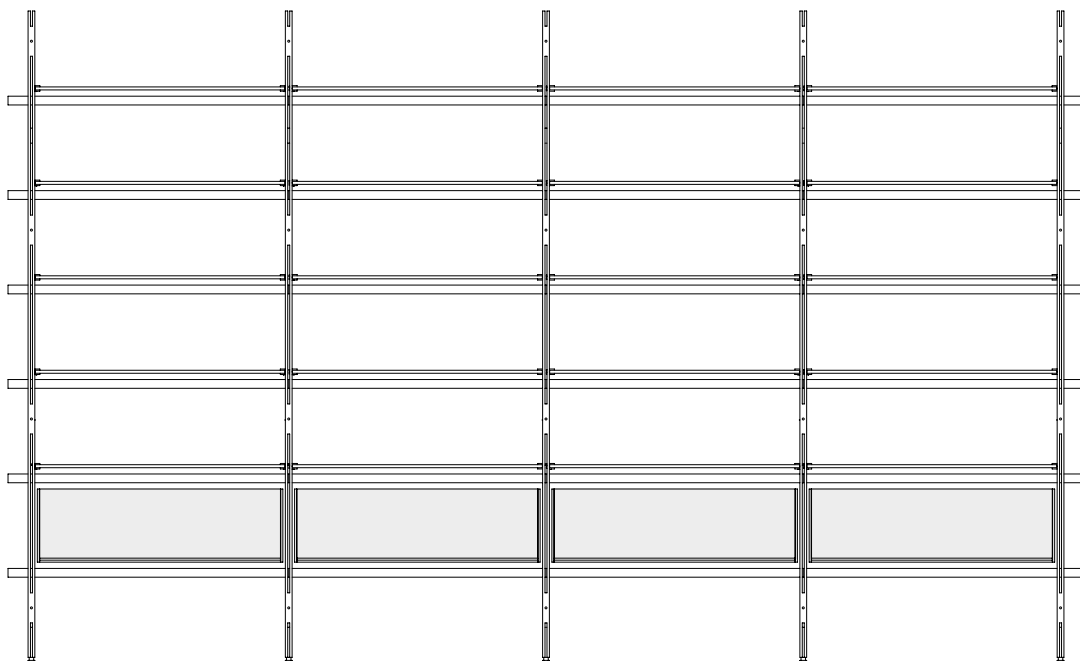

Comp. 503
429,5 x 37 x H 260 cm
5xM2 + 20xR2 + 4xC3
tot. 21.510

design Massimo Castagna 2020

Esempi di composizioni / Examples of compositions
Kompositionbeispiele / Exemples de composition

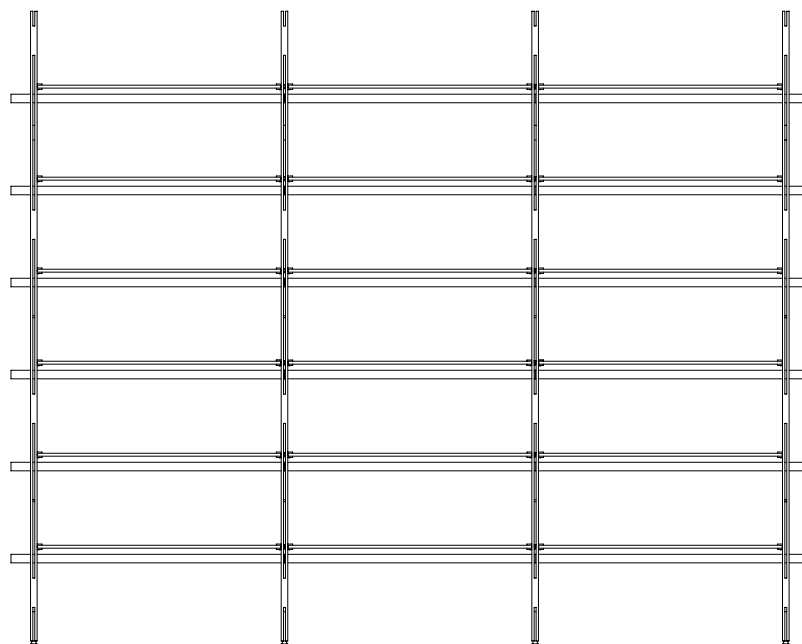

Comp. 405
326,8 x 37 x H 260 cm
4xM2 + 18xR2
tot. 11.860

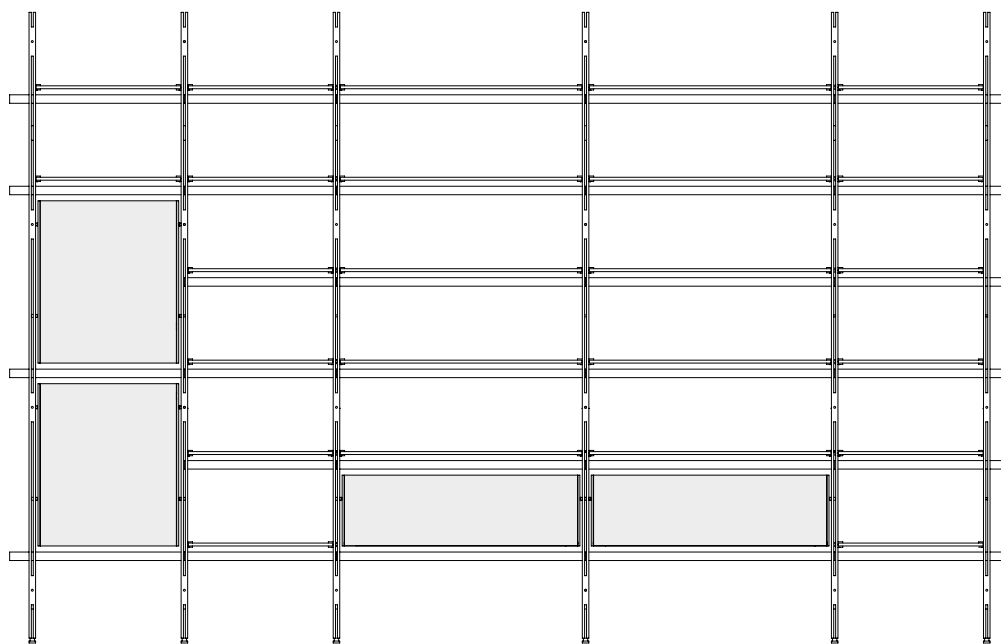

Comp. 601
412,2 x 37 x H 260 cm
6xM2 + 14xR1 + 10xR2 + 2xC5 + 2xC3
tot. 23.780

design Massimo Castagna 2020

Esempi di composizioni / Examples of compositions
Kompositionbeispiele / Exemples de composition

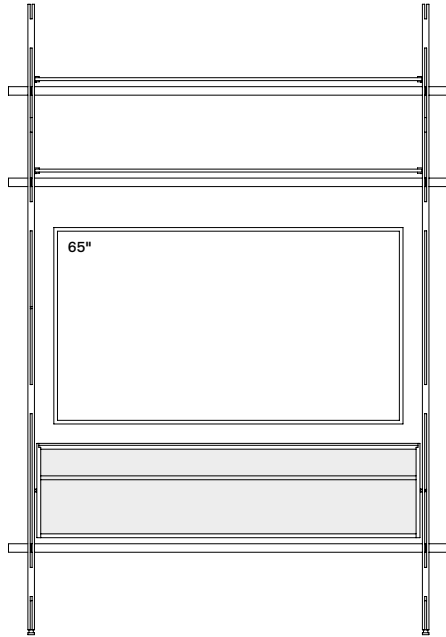

Comp. 217
181,4 x 37 x H 260 cm
2xM2 + 2xR3 + 1xC6
tot. **6.360**

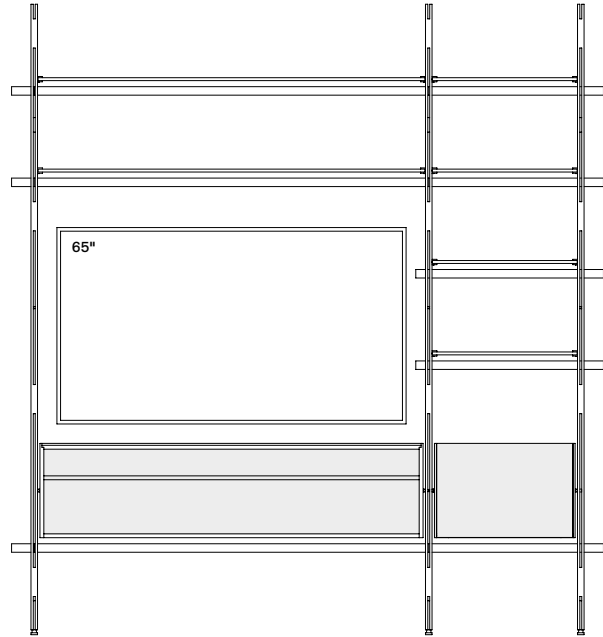

Comp. 309
244,1 x 37 x H 260 cm
3xM2 + 4xR1 + 2xR3 + 1xC2 + 1xC6
tot. **10.860**

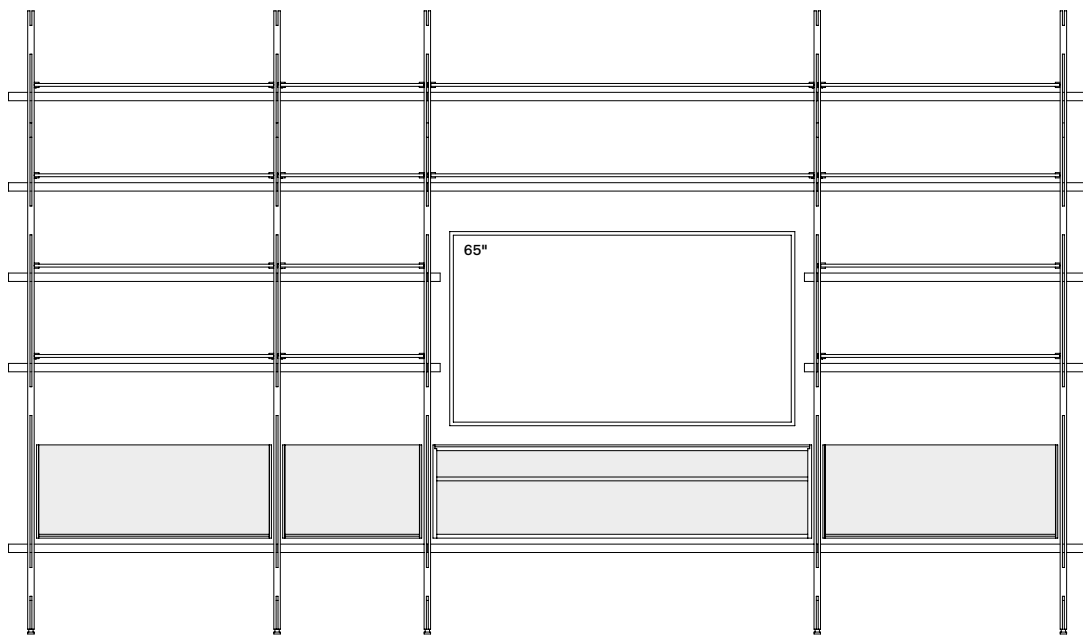

Comp. 501
449,5 x 37 x H 260 cm
5xM2 + 8xR2 + 4xR1 + 2xR3 + 2xC4 + 1xC6 + 1xC2
tot. **20.420**

	I E D F	dimensioni dimension abmessungen dimension	spessore thickness stärke épaisseur	volume volume volumen volume	carico ammesso admitted load tragfähigkeit charge admise	peso weight gewicht poids	prezzo price preis prix
		cm	mm	m3	kg	kg	euro

Quiller libreria

100 x 36 x h 200

15

1,156

25 *

152

3.620

design Uto Balmoral 2016

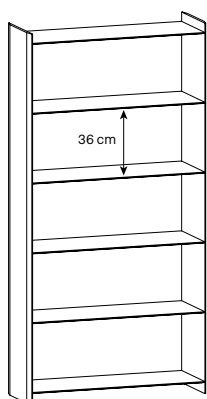

* ogni ripiano / on each shelf / auf jedem Bord / pour chaque étagère

Su richiesta è possibile modificare lo spazio utile tra i ripiani
 On demand the space between the shelves can be modified
 Auf Anfrage kann das lichte Maß zwischen den Fächern geändert werden
 Sur demande l'espace entre les étagères peut être modifié

- Libreria a sei ripiani in vetro extrachiaro con bisellatura da 5cm, utilizzabile sia a parete che freestanding.
- Six shelves bookcase in extra clear glass with 5cm bevelling, can be also freestanding.
- Bücherregal mit 6 Fächern in extrahellem Glas und 5cm Schrägkante, kann gegen die Wand gestellt werden oder frei stehend.
- Bibliothèque à six étagères en verre extra clair avec biseautage de 5cm, utilisable au mur ou indépendant.

vetrine | showcases

	I	dimensioni	spessore	volume	carico ammesso	peso	prezzo
	E	dimension	thickness	volume	admitted load	weight	price
	D	abmessungen	stärke	volumen	tragfähigkeit	gewicht	preis
	F	dimension	épaisseur	volume	charge admise	poids	prix
		cm	mm	m3	kg	kg	euro

Broadway vetrina

Bartoli design 2026

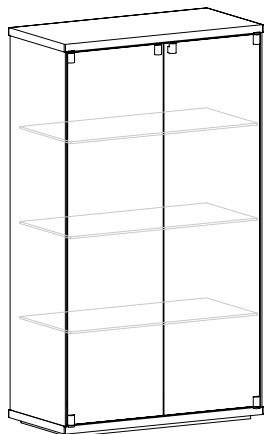

94 x 46 x h 164

6 / 8

0,50

* 15

128

- ● 5.680
- ● 5.720
- ● ● 5.830
- ● ● 5.870
- ● ● 5.840
- ● ● 5.880

- Ripiano in vetro aggiuntivo.
- Additional glass shelf.
- Zusätzlicher Boden.
- Etagère vitrée supplémentaire.

280

* ogni ripiano / on each shelf / auf jedem Bord / pour chaque étagère

Optional Kit illuminazione faretti LED orientabili su top.
Optional lighting kit with adjustable LED spotlights on the top.
Optionales Beleuchtungsset mit verstellbaren LED-Scheinwerfern an der Top.
Kit d'éclairage optionnel avec spots LED réglables sur le dessus.

490

- con serratura / with lock / mit Schloss / avec serrure
- con maniglia / with handle / mit Griff / avec poignée

- Vetro extrachiaro / extra clear glass / extrahelles Glas / verre extra clair
- Vetro fumé / smoked glass / Rauchglas / verre fumé
- Vetro bronzo / bronze glass / Glas Bronze / verre bronze

Specificare sempre la finitura della base e del top: **Champagne o Titanio.**
Always specify the finish of the base and top: **Champagne or Titanio.**
Bitte geben Sie immer die Ausführung von Gestell und Tischplatte an: **Champagner oder Titanio.**
Toujours préciser la finition du socle et du top: **Champagne ou Titanio.**

- Vetrina in vetro temperato extrachiaro, fumè o bronzo, completa di tre ripiani in vetro regolabili in altezza.
La base e il top sono disponibili nelle varianti Titanio e Champagne.
- Display cabinet in extra clear, smoked, or bronze tempered glass, complete with three height-adjustable glass shelves.
The base and top are available in Champagne and Titanio finishes.
- Vitrine aus gehärtetem extrahelles Glas, Rauchglas oder Bronze Glas, komplett mit drei höhenverstellbaren Glasböden.
Sockel und Deckplatte sind in Titanio und Champagner erhältlich.
- Vitrine en verre trempé extra clair, fumé ou bronze, avec trois étagères en verre réglables en hauteur.
Le socle et le plateau sont disponibles en Titanio et Champagne.

	I	dimensioni	spessore	volume	carico ammesso	peso	prezzo
	E	dimension	thickness	volume	admitted load	weight	price
	D	abmessungen	stärke	volumen	tragfähigkeit	gewicht	preis
	F	dimension	épaisseur	volume	charge admise	poids	prix
		cm	mm	m3	kg	kg	euro

Broadway vetrina

49 x 46 x h 164

6 / 8

0,31

* 12

83

● ● 4.240

● ● ● 4.260

■ ● ● 4.350

■ ● ● ● 4.370

■ ● ● 4.360

■ ● ● ● 4.380

Bartoli design 2026

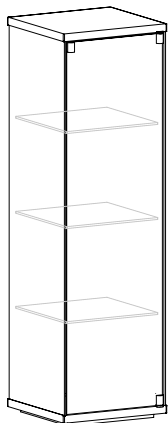

dx / right / recht / droit

- Ripiano in vetro aggiuntivo.
- Additional glass shelf.
- Zusätzlicher Boden.
- Étagère vitrée supplémentaire.

190

* ogni ripiano / on each shelf / auf jedem Bord / pour chaque étagère

Optional Kit illuminazione faretti LED orientabili su top.
Optional lighting kit with adjustable LED spotlights on the top.
Optionales Beleuchtungsset mit verstellbaren LED-Scheinwerfern an der Top.
Kit d'éclairage optionnel avec spots LED réglables sur le dessus.

380

Specificare sempre il verso di apertura dell'anta, destra o sinistra.
Always specify the opening direction of the door, right or left.
Geben Sie immer die Öffnungsrichtung der Tür an, rechts oder links.
Toujours préciser le sens d'ouverture de la porte, à droite ou à gauche.

- con serratura / with lock / mit Schloss / avec serrure
- con maniglia / with handle / mit Griff / avec poignée

- Vetro extrachiaro / extra clear glass / extrahelles Glas / verre extra clair
- Vetro fumé / smoked glass / Rauchglas / verre fumé
- Vetro bronzo / bronze glass / Glas Bronze / verre bronze

Specificare sempre la finitura della base e del top: **Champagne o Titanio.**
Always specify the finish of the base and top: **Champagne or Titanio.**
Bitte geben Sie immer die Ausführung von Gestell und Tischplatte an: **Champagner oder Titanio.**
Toujours préciser la finition du socle et du top: **Champagne ou Titanio.**

- Vetrina in vetro temperato extrachiaro, fumé o bronzo, completa di tre ripiani in vetro regolabili in altezza.
La base e il top sono disponibili nelle varianti Titanio e Champagne.
- Display cabinet in extra clear, smoked, or bronze tempered glass, complete with three height-adjustable glass shelves.
The base and top are available in Champagne and Titanio finishes.
- Vitrine aus gehärtetem extrahelles Glas, Rauchglas oder Bronze Glas, komplett mit drei höhenverstellbaren Glasböden.
Sockel und Deckplatte sind in Titanio und Champagner erhältlich.
- Vitrine en verre trempé extra clair, fumé ou bronze, avec trois étagères en verre réglables en hauteur.
Le socle et le plateau sont disponibles en Titanio et Champagne.

mobili tv | tv units

	I E D F	dimensioni dimension abmessungen dimension	spessore thickness stärke épaisseur	volume volume volumen volume	carico ammesso admitted load tragfähigkeit charge admise	peso weight gewicht poids	prezzo price preis prix
		cm	mm	m3	kg	kg	euro

Comò alto Comò basso

design Marco Gaudenzi 1994

A	113 x 46 x h 65	10 / 12 / 15	0,623	70 + 20 *	108	<input type="checkbox"/>	1.820
B	113 x 45 x h 40	10 / 12 / 15	0,350	80 + 20 *	69	<input type="checkbox"/>	1.320

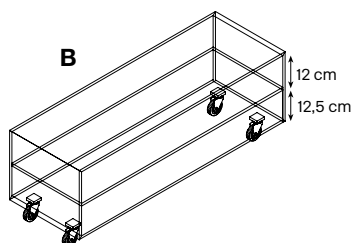
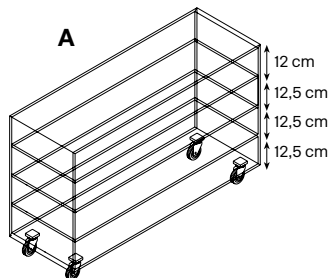

* Ogni ripiano / On each shelf / Auf jedem Bord / Pour chaque étagère
 versione extrachiaro / extraclear version / version extrahell / version extra-claire

- Mobile multiuso su base con ruote.
- Glass-unit for various uses on castors.
- Mehrwertige Glaskommode auf Basis mit Rädern.
- Meuble à multiples emplois sur base avec roulettes.

Cassetti / Drawer / Schublade / Tiroir

U

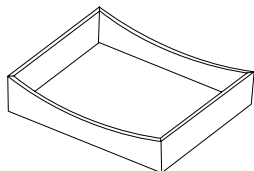

U 54,5 x 44,5 x h 12

Eucalipto Siberian Ash	0,068		5	380
noce canaletto canaletto walnut Walnuß canaletto noyer canaletto	0,068		5	380
RAL	0,068		5	360

H

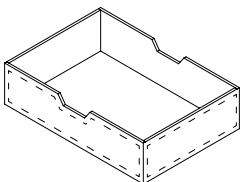

H 54,5 x 44,5 x h 12

Cassetto cuoio naturale o nero Natural or black leather drawer Schublade in Leder natur oder schwarz Tiroir en cuir naturel ou noir	0,068		5	580
--	-------	--	---	------------

	I	dimensioni	spessore	volume	carico ammesso	peso	prezzo
	E	dimension	thickness	volume	admitted load	weight	price
	D	abmessungen	stärke	volumen	tragfähigkeit	gewicht	preis
	F	dimension	épaisseur	volume	charge admise	poids	prix
		cm	mm	m3	kg	kg	euro

WG System

design Massimo Castagna 2023



B1 120 x 46 x h 16	10	0,21	45	38	<input type="checkbox"/>	690
					<input checked="" type="checkbox"/>	710
					<input checked="" type="checkbox"/>	720



B2 120 x 60 x h 16	10	0,25	45	48	<input type="checkbox"/>	790
					<input checked="" type="checkbox"/>	820
					<input checked="" type="checkbox"/>	830



B3 120 x 46 x h 30	10	0,40	45	41	<input type="checkbox"/>	750
					<input checked="" type="checkbox"/>	780
					<input checked="" type="checkbox"/>	790



B4 120 x 60 x h 30	10	0,51	45	52	<input type="checkbox"/>	870
					<input checked="" type="checkbox"/>	900
					<input checked="" type="checkbox"/>	910



B5 179 x 46 x h 16	10	0,30	50	60	<input type="checkbox"/>	920
					<input checked="" type="checkbox"/>	960
					<input checked="" type="checkbox"/>	970



B6 179 x 60 x h 16	10	0,39	50	76	<input type="checkbox"/>	1.020
					<input checked="" type="checkbox"/>	1.060
					<input checked="" type="checkbox"/>	1.070



B7 179 x 46 x h 30	10	0,56	50	66	<input type="checkbox"/>	950
					<input checked="" type="checkbox"/>	990
					<input checked="" type="checkbox"/>	1.000



B8 179 x 60 x h 30	10	0,73	50	82	<input type="checkbox"/>	1.110
					<input checked="" type="checkbox"/>	1.150
					<input checked="" type="checkbox"/>	1.160

Sovrapprezzo per n. 01 foro per passaggio cavi / surcharge for n. 01 cable ducting hole
Aupreis für Nr. 01 Kabeldurchführung / supplément pour n. 01 trou passe-câble

80











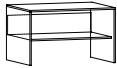

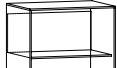
- Vetro extrachiaro / extra clear glass / extrahelles Glas / verre extra clair
- Vetro fumé / smoked glass / Rauchglas / verre fumé
- Vetro bronzo / bronze glass / Bronze Glas / Verre bronze

- Elementi a ponte, ad uso base o piano di appoggio, in vetro saldato extrachiaro, fumé o bronzo. Fori passacavo a richiesta, indicare sempre la posizione.
- Bridge-like elements used as base or countertop, in glued extra clear, smoked or bronze glass. On request cable ducting hole, always indicate position.
- Brückenformige Elemente zur Verwendung als Grundelement oder Ablage, aus verklebtem extrahellem Glas, Rauchglas oder Bronze Glas. Auf Anfrage Kabeldurchführung, immer Position angeben.
- Eléments à pont à usage base ou plan d'appui, en verre collé extra clair, fumé ou bronze. Sur demande trou passe-câble, indiquer toujours la position.

	I	dimensioni	spessore	volume	carico ammesso	peso	prezzo
	E	dimension	thickness	volume	admitted load	weight	price
	D	abmessungen	stärke	volumen	tragfähigkeit	gewicht	preis
	F	dimension	épaisseur	volume	charge admise	poids	prix
		cm	mm	m3	kg	kg	euro

WG System

design Massimo Castagna 2023

WG-61		P1 61x46xh37	10	0,19	40	41	<input type="checkbox"/> 750 <input checked="" type="checkbox"/> 780 <input type="checkbox"/> 790
		P2 61x60xh37	10	0,24	40	47	<input type="checkbox"/> 850 <input checked="" type="checkbox"/> 880 <input type="checkbox"/> 890
		P3 61x46xh50	10	0,25	40	49	<input type="checkbox"/> 820 <input checked="" type="checkbox"/> 850 <input type="checkbox"/> 860
		P4 61x60xh50	10	0,32	40	59	<input type="checkbox"/> 930 <input checked="" type="checkbox"/> 960 <input type="checkbox"/> 970
WG-120		P5 120x46xh37	10	0,36	45	64	<input type="checkbox"/> 1.080 <input checked="" type="checkbox"/> 1.120 <input type="checkbox"/> 1.130
		P6 120x60xh37	10	0,46	45	72	<input type="checkbox"/> 1.220 <input checked="" type="checkbox"/> 1.260 <input type="checkbox"/> 1.270
		P7 120x46xh50	10	0,48	45	74	<input type="checkbox"/> 1.190 <input checked="" type="checkbox"/> 1.230 <input type="checkbox"/> 1.240
		P8 120x60xh50	10	0,62	45	84	<input type="checkbox"/> 1.320 <input checked="" type="checkbox"/> 1.370 <input type="checkbox"/> 1.380
WG-179		P9 179x46xh37	10	0,51	50	86	<input type="checkbox"/> 1.440 <input checked="" type="checkbox"/> 1.490 <input type="checkbox"/> 1.500
		P10 179x60xh37	10	0,69	50	98	<input type="checkbox"/> 1.600 <input checked="" type="checkbox"/> 1.650 <input type="checkbox"/> 1.660
		P11 179x46xh50	10	0,70	50	100	<input type="checkbox"/> 1.540 <input checked="" type="checkbox"/> 1.590 <input type="checkbox"/> 1.600
		P12 179x60xh50	10	0,91	50	114	<input type="checkbox"/> 1.730 <input checked="" type="checkbox"/> 1.780 <input type="checkbox"/> 1.790

Sovrapprezzo per n. 01 foro per passaggio cavi / surcharge for no. 01 cable ducting hole
Aupreis für Nr. 01 Kabeldurchführung / supplément pour n. 01 trou passe-câble

80

- Vetro extrachiaro / extra clear glass / extrahelles Glas / verre extra clair
- Vetro fumé / smoked glass / Rauchglas / verre fumé
- Vetro bronzo / bronze glass / Bronze Glas / Verre bronze





- Sistema modulare di elementi in vetro saldato extrachiaro, fumé o bronzo con ripiano e schienale per alloggiare contenitori e optional in legno di pagina 155. Fori passacavo a richiesta, indicare sempre la posizione.
- Modular system of elements in glued glass extra clear, smoked or bronze with shelf and back panel to accommodate wooden storage units and optional elements of page 155. On request cable ducting hole, always indicate position.
- Modulares System aus verklebten Glaselementen in extrahell, Rauchglas oder Bronze mit Fach und Rückwand für Integrierung von Behältern und optionalen Elementen aus Holz siehe Seite 155. Auf Anfrage Kabeldurchführung, immer Position angeben.
- Système modulaire de éléments en verre collé extra clair, fumé ou bronze avec étagère et dos pour accueillir conteneurs et optionnels en bois de la page 155. Sur demande trou passe-câble, indiquer toujours la position.

	I	dimensioni	spessore	volume	carico ammesso	peso	prezzo
	E	dimension	thickness	volume	admitted load	weight	price
	D	abmessungen	stärke	volumen	tragfähigkeit	gewicht	preis
	F	dimension	épaisseur	volume	charge admise	poids	prix
		cm	mm	m3	kg	kg	euro

WG System

design Massimo Castagna 2023

OPTIONAL PER SISTEMA MODULARE DI PAG 204.
 OPTIONALS FOR MODULAR SYSTEM OF PAGE 204.
 OPTIONALE ELEMENTE FÜR MODULARES SYSTEM AUF SEITE 204.
 OPTIONS POUR SYSTEM MODULAIRE DE LA PAGE 204.

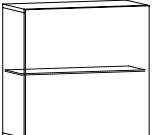
EG1		59 x 45 x h 13		0,06	10	7	320
Elemento a giorno / open element / offenes Element / élément ouvert							
CB1		59 x 45 x h 13		0,06	10	16	680
Cassetto / drawer / Schublade / tiroir							
CA2		59 x 45 x h 26		0,11	15	20	980
Cassettone /jumbo drawer /große Schublade / tiroir grande							
ER1		59 x 45 x h 26		0,11	15	13	890
Contenitore a ribalta / storage unit with flap door / Schließfach mit Klapptür / récipient avec porte à abattant							
EB1		60 x 30 x h 60		0,21	20	38	1.280
Contenitore battente in appoggio con ripiano interno in vetro countertop storage unit with hinge door and internal glass shelf auflegendes Schließfach mit Flügeltür und inneres Glasfach récipient en appui avec porte à battant et étagère en verre							

Sovrapprezzo per n. 01 foro per passaggio cavi, completo di passacavo **120**
 surcharge for no. 01 cable ducting hole, including cable duct
 Aufpreis für Nr. 01 Kabeldurchführung inkl. Lochdeckel
 supplément pour n. 01 trou passe-câble inclu couverture trou.

Specificare la finitura in legno dei contenitori e degli optional SIBERIAN ASH, EUCALIPTO o ROVERE NATURALE
 Specify wood finish of storage unit and optional elements SIBERIAN ASH, EUCALIPTO or NATURAL OAK
 Holzausführung der Behälter und optionalen Teile angeben SIBERIAN ASH, EUCALIPTO oder EICHE NATUR
 Indiquer finition bois des récipients et des éléments optionnels SIBERIAN ASH, EUCALIPTO ou ROUVRE NATUREL

- Optional in legno Siberian Ash, Eucalipto o Rovere Naturale per elementi di pag. 204.
Fori passacavo a richiesta, indicare sempre la posizione.
- Optional in wood Siberian Ash, Eucalipto or Natural Oak for elements of page 204.
On request cable ducting hole, always indicate position.
- Optionale Elemente in Holz Siberian Ash, Eucalipto oder Natureiche für Element auf Seite 204.
Auf Anfrage Kabeldurchführung, immer Position angeben.
- Optionnels en bois Siberian Ash, Eucalipto ou Rouvre Naturel pour les éléments de page 204.
Sur demande trou passe-câble, toujours indiquer position.

	M1 120 x 30 x h 5	4	0,06	40	30	● 590 ●● 660 ●●● 670
	M2 180 x 30 x h 5	4	0,09	45	44	● 830 ●● 910 ●●● 920
	M3 240 x 30 x h 5	4	0,12	50	60	● 980 ●● 1.080 ●●● 1.090

- Specchio / Mirror / Spiegel / Miroir
- Specchio fumè / Smoked mirror / Rauchglasspiegel / miroir fumè
- Specchio bronzo / Bronze mirror / Bronze Spiegel / Miroir bronze

- Mensole a parete rivestite in specchio, specchio fumè e specchio bronzo.
- Wall shelves covered in mirror, smoked mirror and bronze mirror.
- Wandkonsolen beschichte mit Spiegel, Rauchglasspiegel und Bronze Spiegel.
- Étagère au mur revêtu en miroir, miroir fumè et miroir bronze.

WG System

design Massimo Castagna 2023

- Esempi di configurazione
- Composition examples
- Kompositionsbeispiele
- Exemples de composition

WG-61

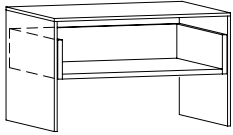

S1

61 x 46 x h 37
P1+EG1

- 1.070
- 1.100
- 1.110

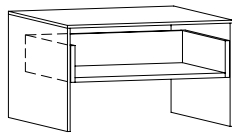

S2

61 x 60 x h 37
P2+EG1

- 1.170
- 1.200
- 1.210

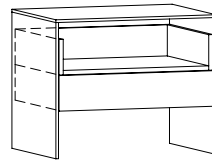

S3

61 x 46 x h 50
P3+EG1+CB1

- 1.820
- 1.850
- 1.860

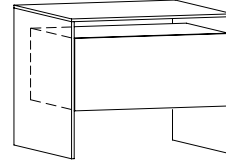

S4

61 x 60 x h 50
P4+CA2

- 1.910
- 1.940
- 1.950

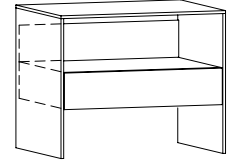

S5

61 x 46 x h 50
P3+CB1

- 1.500
- 1.530
- 1.540

WG-120

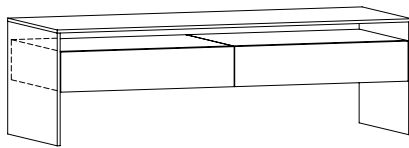

S10

120 x 46 x h 37
P5+2 CB1

- 2.440
- 2.480
- 2.490

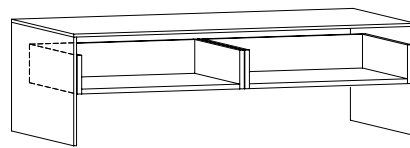

S11

120 x 60 x h 37
P6+2 EG1

- 1.860
- 1.900
- 1.910

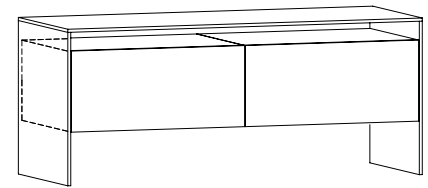

S12

120 x 46 x h 50
P5+2 ER1

- 2.860
- 2.900
- 2.910

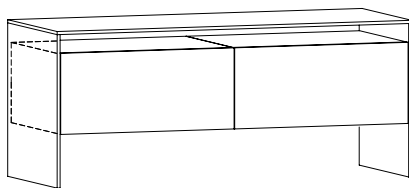

S13

120 x 46 x h 50
P7+2 CA2

- 3.150
- 3.190
- 3.200

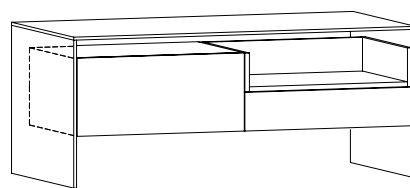

S14

120 x 60 x h 50
P8+ER1+CB1+EG1

- 3.210
- 3.260
- 3.270

- Vetro extrachiaro / extra clear glass / extrahelles Glas / verre extra clair
- Vetro fumé / smoked glass / Rauchglas / verre fumé
- Vetro bronzo / bronze glass / Bronze Glas / Verre bronze

WG System

design Massimo Castagna 2023

- Esempi di configurazione
- Composition examples
- Kompositionsbeispiele
- Exemples de composition

WG-179

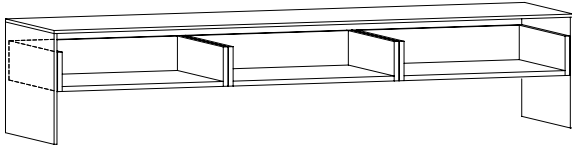

S20

179 x 46 x h 37
P9+3 EG1

- 2.400
- 2.450
- 2.460

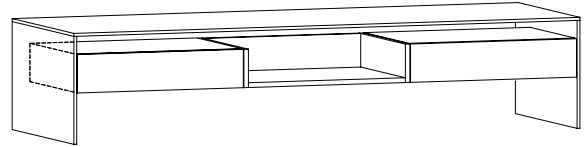

S21

179 x 60 x h 37
P10+EG1+2 CB1

- 3.280
- 3.330
- 3.340

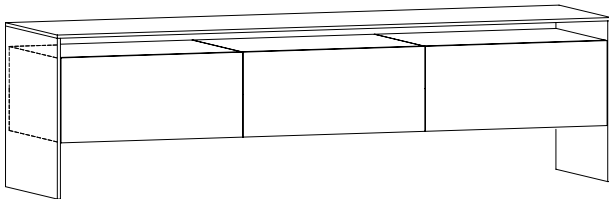

S22

179 x 46 x h 50
P11+3 CA2

- 4.480
- 4.530
- 4.540

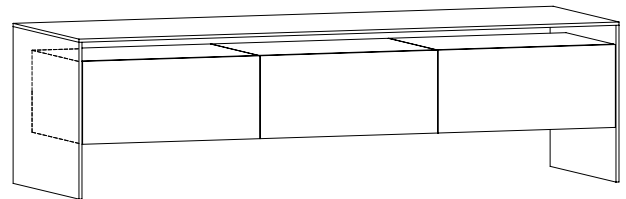

S23

179 x 60 x h 50
P12+3 ER1

- 4.400
- 4.450
- 4.460

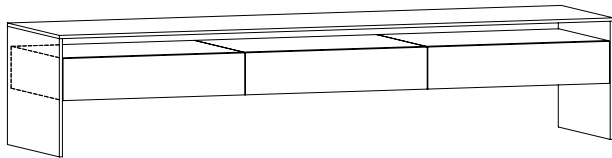

S24

179 x 46 x h 37
P9+3 CB1

- 3.480
- 3.530
- 3.540

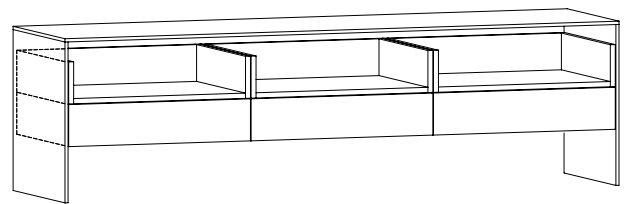

S25

179 x 46 x h 50
P11+3 CB1+3 EG1

- 4.540
- 4.590
- 4.600

- Vetro extrachiaro / extra clear glass / extrahelles Glas / verre extra clair
- Vetro fumé / smoked glass / Rauchglas / verre fumé
- Vetro bronzo / bronze glass / Bronze Glas / Verre bronze

WG System

design Massimo Castagna 2023

Composizioni / compositions / Kompositionen / compositions

COMP 1

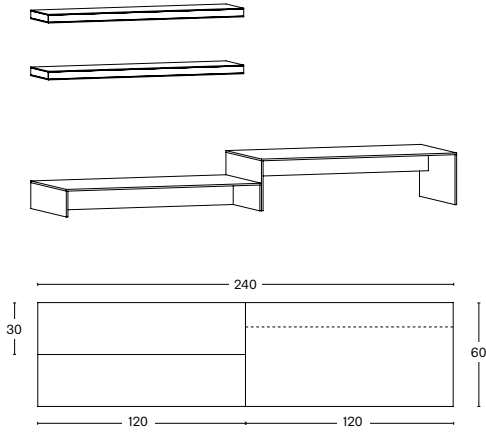

			□	■	■
2	M1	120x30xH5	590	660	670
1	B2	120x60xH16	790	820	830
1	B4	120x60xH30	870	900	910
TOTALE COMPOSIZIONE / TOTAL LAYOUT			2.840	3.040	3.080

- Vetro extrachiaro / extra clear glass / extrahelles Glas / verre extra clair
- Vetro fumé / smoked glass / Rauchglas / verre fumé
- Vetro bronzo / bronze glass / Bronze Glas / Verre bronze

COMP 2

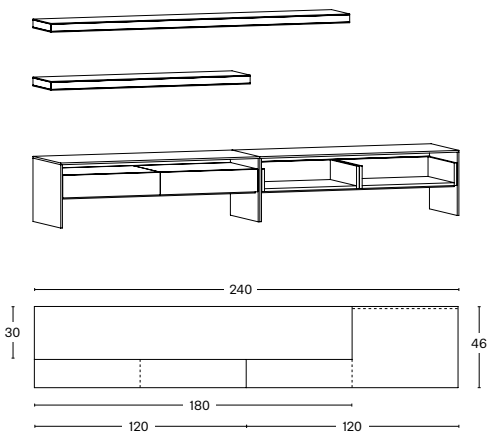

			□	■	■
1	M2	180x30xH5	830	910	920
1	M1	120x30xH5	590	660	670
1	P7	120x46xH50	1.190	1.230	1.240
2	CB1	59x45xH13	680		
1	P7	120x46xH50	1.190	1.230	1.240
2	EG1	59x45xH13	320		
TOTALE COMPOSIZIONE / TOTAL LAYOUT			5.800	6.030	6.070

- Vetro extrachiaro / extra clear glass / extrahelles Glas / verre extra clair
- Vetro fumé / smoked glass / Rauchglas / verre fumé
- Vetro bronzo / bronze glass / Bronze Glas / Verre bronze

COMP 3

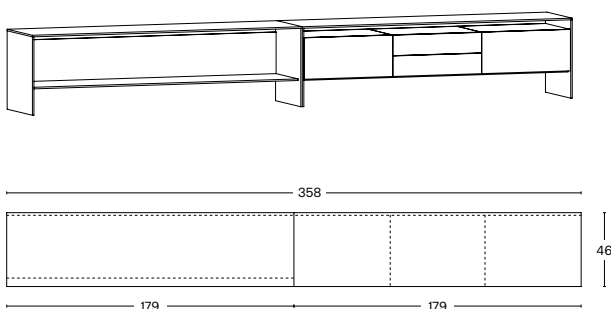

			□	■	■
1	P11	179x46xH50	1.540	1.590	1.600
1	P11	179x46xH50	1.540	1.590	1.600
2	ER1	59x45xH26	890		
2	CB1	59x45xH13	680		
TOTALE COMPOSIZIONE / TOTAL LAYOUT			6.220	6.320	6.340

- Vetro extrachiaro / extra clear glass / extrahelles Glas / verre extra clair
- Vetro fumé / smoked glass / Rauchglas / verre fumé
- Vetro bronzo / bronze glass / Bronze Glas / Verre bronze

WG System

design Massimo Castagna 2023

Composizioni / compositions / Kompositionen / compositions

COMP 4

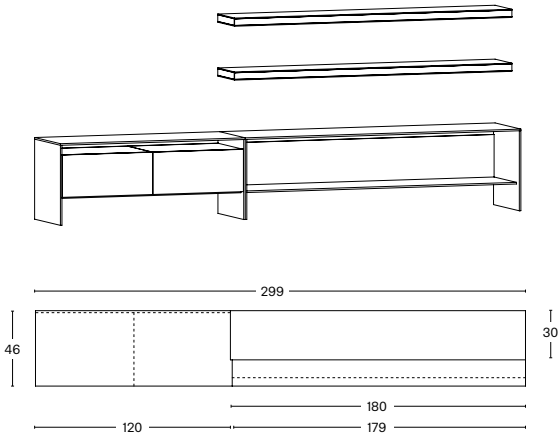

			□	■	■
2	M2	180x30xH5	830	910	920
1	P7	120x46xH50	1.190	1.230	1.240
2	ER1	59x45xH26	890		
1	P11	179x46xH50	1.540	1.590	1.600
TOTALE COMPOSIZIONE / TOTAL LAYOUT			6.170	6.420	6.460

- Vetro extrachiaro / extra clear glass / extrahelles Glas / verre extra clair
- Vetro fumé / smoked glass / Rauchglas / verre fumé
- Vetro bronzo / bronze glass / Bronze Glas / Verre bronze

COMP 5

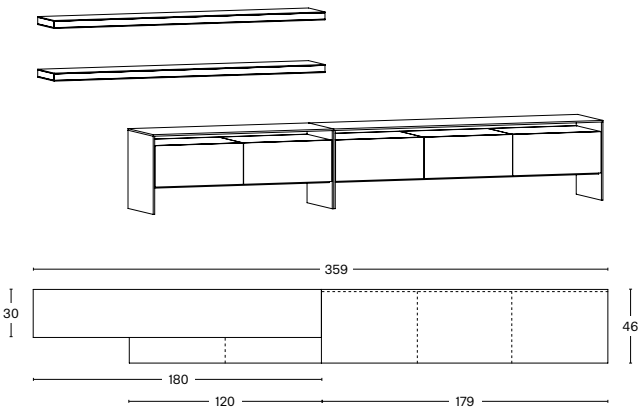

			□	■	■
2	M2	180x30xH5	830	910	920
1	P7	120x46xH50	1.190	1.230	1.240
2	CA2	59x45xH26	980		
1	P11	179x46xH50	1.540	1.590	1.600
3	ER1	59x45xH26	890		
TOTALE COMPOSIZIONE / TOTAL LAYOUT			9.020	9.270	9.300

- Vetro extrachiaro / extra clear glass / extrahelles Glas / verre extra clair
- Vetro fumé / smoked glass / Rauchglas / verre fumé
- Vetro bronzo / bronze glass / Bronze Glas / Verre bronze

COMP 6

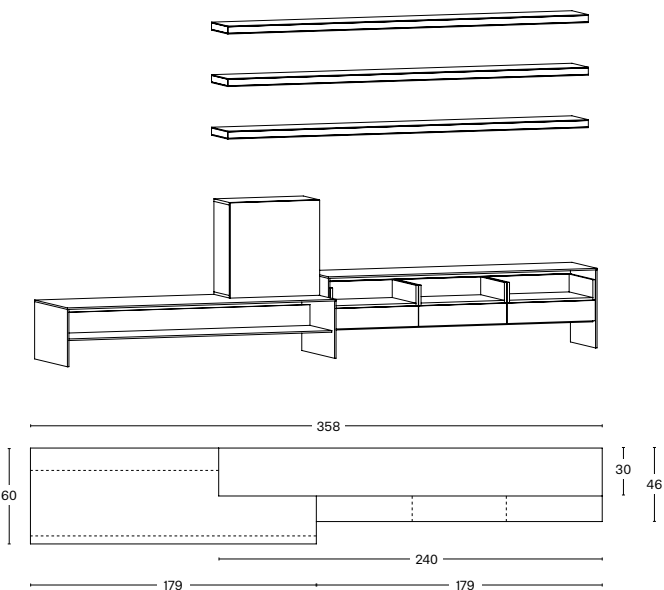

			□	■	■
3	M3	240x30xH5	980	1.080	1.090
1	P10	179x60xH37	1.600	1.650	1.660
1	P11	179x46xH50	1.540	1.590	1.600
3	CB1	59x45xH13	680		
3	EG1	59x45xH13	320		
1	EB1	60x30xH60	1.280		
TOTALE COMPOSIZIONE / TOTAL LAYOUT			10.360	10.760	10.810

- Vetro extrachiaro / extra clear glass / extrahelles Glas / verre extra clair
- Vetro fumé / smoked glass / Rauchglas / verre fumé
- Vetro bronzo / bronze glass / Bronze Glas / Verre bronze

divani | sofas

Soft glass

design Massimo Castagna 2023

SG001

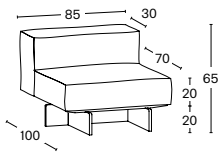

85 x 100 x h 65

dimensioni / dimension / abmessungen / dimension 85 x 100 x h 65					
TESSUTO / FABRIC / STOFF / TISSU					
C	P	H	F	B	D
2.940	2.970	3.120	3.200	3.290	3.360

SG005 - CHAISE LONGUE

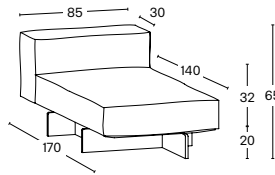

85 x 170 x h 65

dimensioni / dimension / abmessungen / dimension 85 x 170 x h 65					
TESSUTO / FABRIC / STOFF / TISSU					
C	P	H	F	B	D
4.580	4.620	4.810	4.960	5.090	5.180

SG010

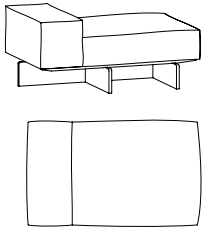

SG011

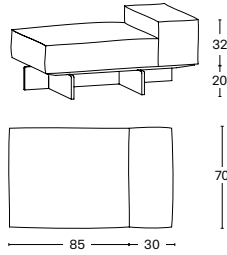

115 x 70 x h 52

dimensioni / dimension / abmessungen / dimension 115 x 70 x h 52					
TESSUTO / FABRIC / STOFF / TISSU					
C	P	H	F	B	D
2.700	2.730	2.880	2.920	3.010	3.080

SG020

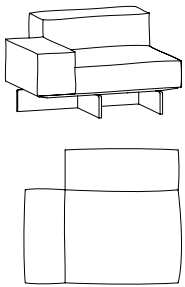

SG021

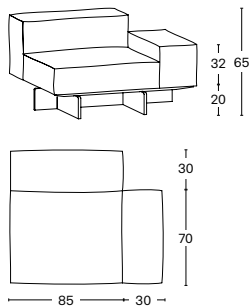

115 x 100 x h 65

dimensioni / dimension / abmessungen / dimension 115 x 100 x h 65					
TESSUTO / FABRIC / STOFF / TISSU					
C	P	H	F	B	D
3.820	3.860	4.080	4.170	4.310	4.410

SG030

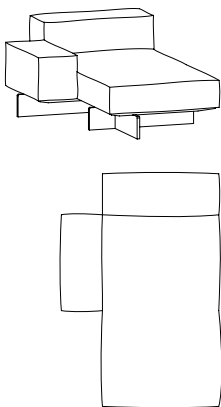

SG031

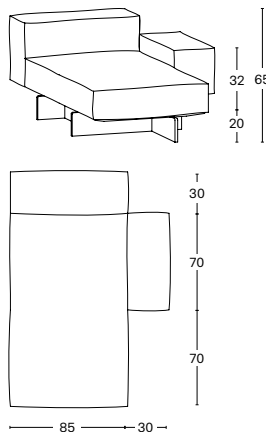

115 x 170 x h 65

dimensioni / dimension / abmessungen / dimension 115 x 170 x h 65					
TESSUTO / FABRIC / STOFF / TISSU					
C	P	H	F	B	D
5.450	5.510	5.800	5.930	6.110	6.230

SG040

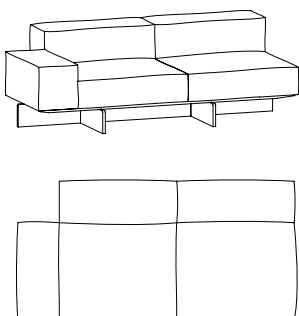

SG041

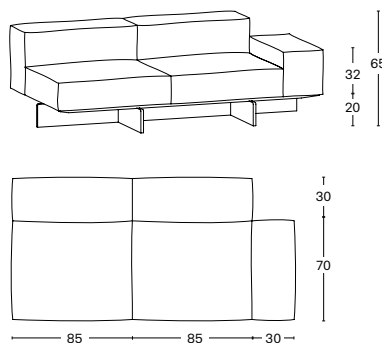

200 x 100 x h 65

dimensioni / dimension / abmessungen / dimension 200 x 100 x h 65					
TESSUTO / FABRIC / STOFF / TISSU					
C	P	H	F	B	D
6.110	6.180	6.550	6.720	6.950	7.120

Soft glass

design Massimo Castagna 2023

SG050

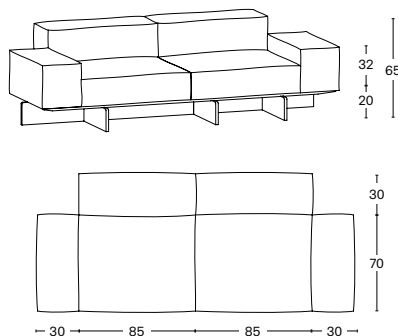

230 x 100 x h 65

dimensioni / dimension / abmessungen / dimension 230 x 100 x h 65					
TESSUTO / FABRIC / STOFF / TISSU					
C	P	H	F	B	D
6.970	7.050	7.490	7.670	7.940	8.140

SG060

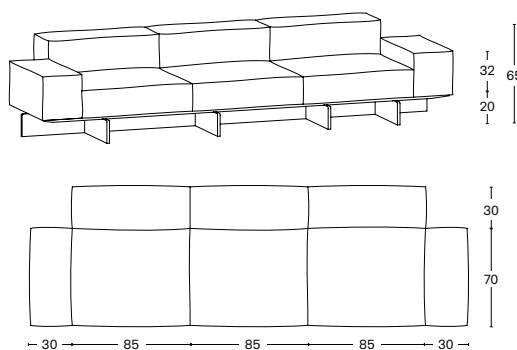

315 x 100 x h 65

dimensioni / dimension / abmessungen / dimension 315 x 100 x h 65					
TESSUTO / FABRIC / STOFF / TISSU					
C	P	H	F	B	D
9.340	9.450	10.040	10.280	10.660	10.930

SG070

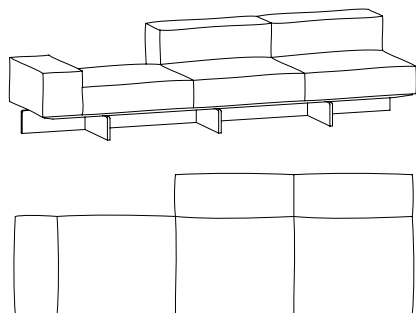

SG071

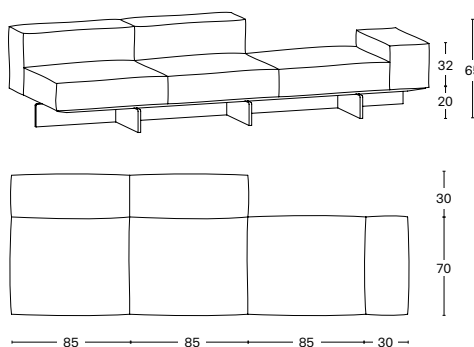

dimensioni / dimension / abmessungen / dimension 285 x 100 x h 65					
TESSUTO / FABRIC / STOFF / TISSU					
C	P	H	F	B	D
8.060	8.140	8.590	8.780	9.070	9.280

285 x 100 x h 65

Specificare sempre la finitura del basamento in vetro **EXTRACHIARO, FUMÈ O BRONZO**
 always specify finish of glass base **EXTRA CLEAR, SMOKED OR BRONZE**.
 immer Ausführung des Gestell angeben **EXTRAHELLES GLAS, RAUCHGLAS ODER BRONZE GLAS**
 spécifier toujours finition du piètement en verre **EXTRA CLAIR, FUME' OU BRONZE**.

- Divano con struttura portante in legno listellare su basi in vetro stratificato e saldato spessore 20mm, extrachiaro, fumè e bronzo. Sedute, schienali e braccioli imbottiti in poliuretano espanso a densità variabile con materassina in fiocco di fibre acriliche e rivestiti con tessuto protettivo. Rivestimento esterno in tessuto sfoderabile con cucitura doppia a vista. Per finiture tessuti vedi catalogo pagine 350-351. con materassina rivestita con falde di fibre acriliche.
- Sofa with supporting structure made of blockboard on stratified and glued glass of 20mm thickness, extra clear, smoked and bronze. Seatings, backrests and armrests upholstered with differentiated density polyurethane foam and with a mat of acrylic fibers with protective fabric. External lining in removable fabric with visible double stitching. For available fabric finishes see catalogue pages 350-351.
- Sofa mit Tragwerk aus Mehrschichtholz auf Gestell in Schichtglas Stärke 20mm, extrahelles Glas, Rauchglas oder Bronze Glas. Sitzfläche, Rückenlehne und Armlehnen mit Polyurethanschaum mit unterschiedlicher Dichte gepoltert und mit Schutzstoff bezogen. Außenverkleidung aus abziehbarem Stoff mit doppelter sichtlicher Naht. Für verfügbare Stoffe siehe Katalog Seiten 350-351.
- Canapé avec structure portante en bois multicouche sur bases en verre stratifié et collé épaisseur 20mm, extra clair, fumé ou bronze. Assises, dos et bras capitonné en mousse de polyuréthane à densité variable revêtu avec un tapis de fibres acryliques et tissu de protection. Revêtement extérieur en tissu amovible avec double couture à vue. Pour les finitions tissu voir catalogues pages 350-351.

Soft glass

design Massimo Castagna 2023

- Esempi di configurazione
- Composition examples
- Kompositionsbeispiele
- Exemples de composition

Composizione **Z** SG010+SG041

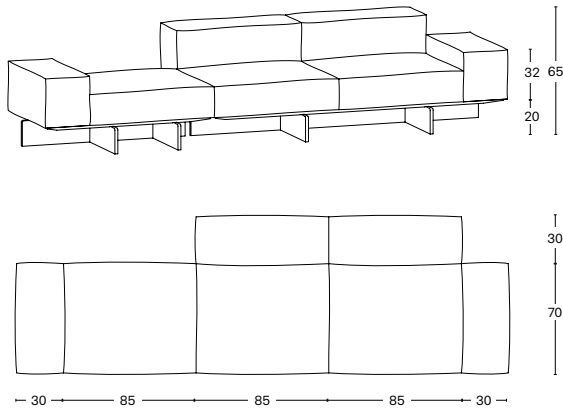

dimensioni / dimension / abmessungen / dimension 315 x 100 x h 65					
TESSUTO / FABRIC / STOFF / TISSU					
C	P	H	F	B	D
8.810	8.910	9.430	9.640	9.960	10.200

315 x 100 x h 65

Composizione **W** SG040+SG031

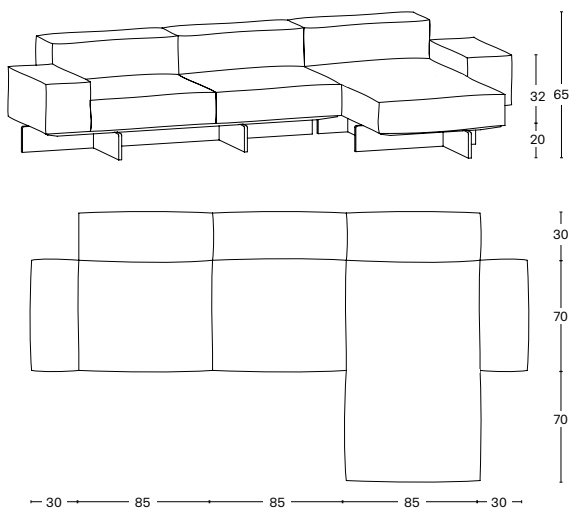

dimensioni / dimension / abmessungen / dimension 315 x 170 x h 65					
TESSUTO / FABRIC / STOFF / TISSU					
C	P	H	F	B	D
11.560	11.690	12.320	12.650	13.060	13.350

315 x 170 x h 65

Soft glass

design Massimo Castagna 2023

- Esempi di configurazione
- Composition examples
- Kompositionsbeispiele
- Exemples de composition

Composizione V SG040+SG041

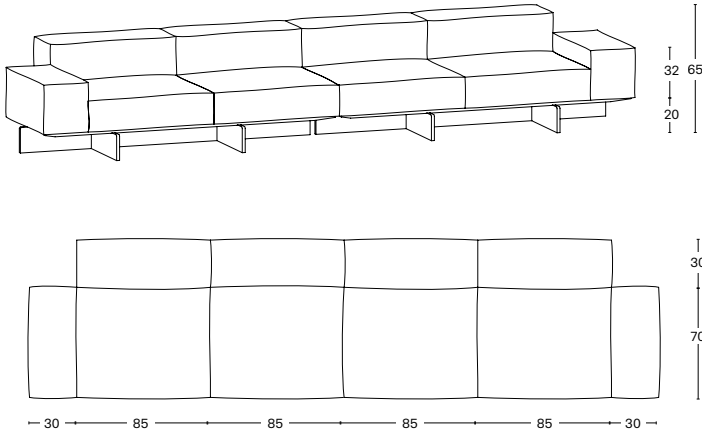

dimensioni / dimension / abmessungen / dimension 400 x 100 x h 65					
TESSUTO / FABRIC / STOFF / TISSU					
C	P	H	F	B	D
12.220	12.360	13.100	13.440	13.900	14.240

400 x 100 x h 65

Composizione Y SG040+SG060

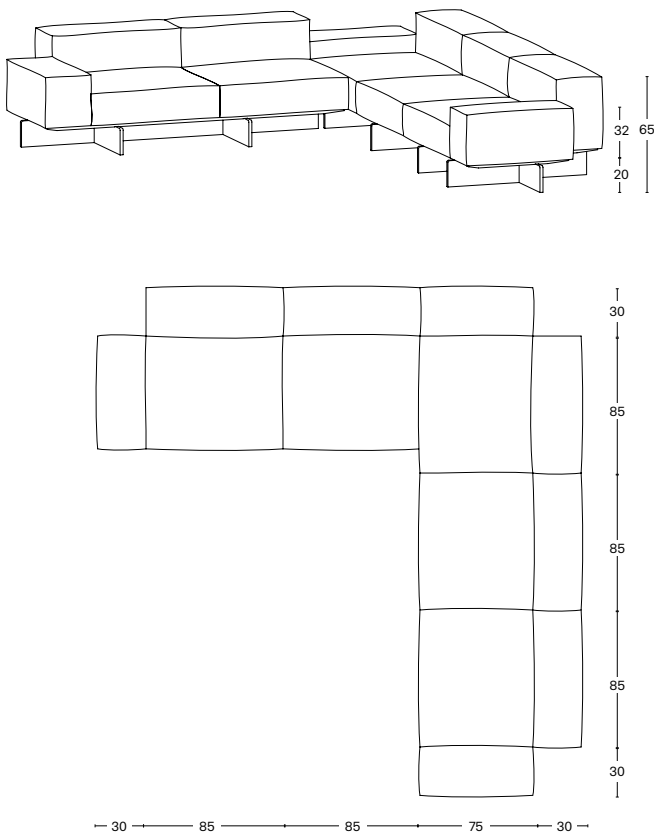

dimensioni / dimension / abmessungen / dimension 300 x 315 x h 65					
TESSUTO / FABRIC / STOFF / TISSU					
C	P	H	F	B	D
15.450	15.630	16.590	17.000	17.610	18.050

300 x 315 x h 65

	I	dimensioni	spessore	volume	carico ammesso	peso	prezzo
	E	dimension	thickness	volume	admitted load	weight	price
	D	abmessungen	stärke	volumen	tragfähigkeit	gewicht	preis
	F	dimension	épaisseur	volume	charge admise	poids	prix
		cm	mm	m3	kg	kg	euro

Soft glass cushion

design Massimo Castagna 2023

SGC50



- Cuscino 50x50 cm in fibre acriliche anallergiche, rivestito in tessuto, sfoderabile.
- Cushion 50x50 cm of hypoallergenic acrylic fibers, covered in fabric, removable cover.
- Kissen 50x50 cm aus hypoallergenen Acrylfasern, mit Stoff bezogen, abnehmbar.
- Coussin 50x50 cm en flocons de fibres acryliques hypoallergéniques, recouvert de tissu, déhoussable.

dimensioni / dimension / abmessungen / dimension 50 x 50					
TESSUTO / FABRIC / STOFF / TISSU					
C	P	H	F	B	D
180	185	205	225	240	245

SGC70

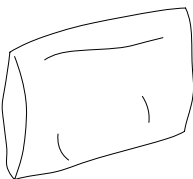

- Cuscino 70x35 cm in fibre acriliche anallergiche, rivestito in tessuto, sfoderabile.
- Cushion 70x35 cm of hypoallergenic acrylic fibers, covered in fabric, removable cover.
- Kissen 70x35 cm aus hypoallergenen Acrylfasern, mit Stoff bezogen, abnehmbar.
- Coussin 70x35 cm en flocons de fibres acryliques hypoallergéniques, recouvert de tissu, déhoussable.

dimensioni / dimension / abmessungen / dimension 70 x 35					
TESSUTO / FABRIC / STOFF / TISSU					
C	P	H	F	B	D
250	255	285	310	335	340

SGC85

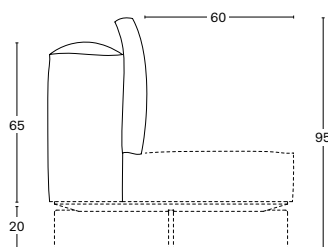
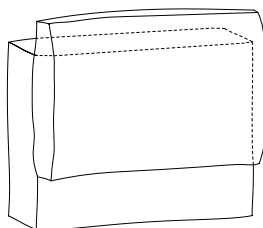

- Cuscino 85x55 in fibre acriliche anallergiche, rivestito in tessuto sfoderabile. Abbinato sempre allo schienale del divano maggiorato in altezza a 65 cm. Il prezzo del cuscino è da intendersi comprensivo dello schienale più alto. La finitura del tessuto è sempre la stessa dello schienale.
- Cushion 85x55 in hypoallergenic acrylic fibers, covered in removable fabric. Always combined with the backrest of the sofa increased in height to 65 cm. The price of the cushion is intended as inclusive of the higher backrest. The fabric finish is always the same as the backrest.
- Kissen 85x55 aus antiallergischen Acrylfasern, mit abnehmbarem Stoffbezug. Immer kombiniert mit der auf 65 cm erhöhten Rückenlehne des Sofas. Der Preis des Kissens versteht sich inklusive der höheren Rückenlehne. Die Stoffausführung ist immer die gleiche wie die der Rückenlehne.
- Coussin 85x55 en fibres acryliques hypoallergéniques, recouvert de tissu déhoussable. Toujours combiné avec le dos du canapé augmenté en hauteur à 65 cm. Le prix du coussin comprend le dossier le plus haut. La finition du tissu est toujours la même que celle du dos.

dimensioni / dimension / abmessungen / dimension 85 x 55					
TESSUTO / FABRIC / STOFF / TISSU					
C	P	H	F	B	D
435	440	445	450	480	490

	I	dimensioni	spessore	volume	carico ammesso	peso	prezzo
	E	dimension	thickness	volume	admitted load	weight	price
	D	abmessungen	stärke	volumen	tragfähigkeit	gewicht	preis
	F	dimension	épaisseur	volume	charge admise	poids	prix
		cm	mm	m3	kg	kg	euro

Soft glass side

35 x 98 x h 36

design Massimo Castagna 2024

□ 780

■ 800

■ 810

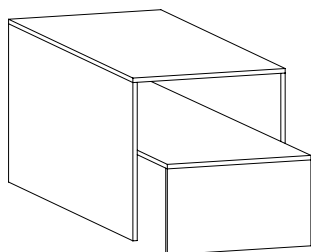

□ Vetro extrachiaro / extra clear glass / extrahelles Glas / verre extra clair

■ Vetro fumé / smoked glass / Rauchglas / verre fumé

■ Vetro bronzo / bronze glass / Bronze Glas / Verre bronze

- Fianco divano in vetro saldato nelle finiture extrachiaro, fumé o bronzo.

- Side table in welded glass in finishes extra clear, smoked or bronze.

- Beistelltisch aus geschweißtem Glas in Ausführung extrahell, Rauchfarbe oder Bronze.

- Table de chevet en verre soudé en finitions extra clair, fumé ou bronze.

poltrone | armchairs

	I	dimensioni	spessore	volume	carico ammesso	peso	prezzo
	E	dimension	thickness	volume	admitted load	weight	price
	D	abmessungen	stärke	volumen	tragfähigkeit	gewicht	preis
	F	dimension	épaisseur	volume	charge admise	poids	prix
		cm	mm	m3	kg	kg	euro

Naked

design G.T. Garattoni 2002

72 x 90 x h 76

20

10 + 10

10 + 10

0,224

130

67

□ 4.230

■ 4.270

■ 4.280

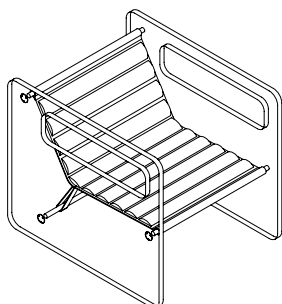

- Vetro extrachiaro / extra clear glass / extrahellem Glas / verre extra clair
- Vetro fumé / smoked glass / Rauchglas / verre fumé
- Vetro bronzo / bronze glass / Glas Bronze / verre bronze

- Poltrona in vetro temperato extrachiaro e vetro stratificato fumé o bronzo.
Seduta realizzata in pelle in tutte le varianti della gamma (vedi catalogo), imbottita in poliuretano espanso a densità variabile.
Parti metalliche in finitura cromo lucido.
- Armchair in extra clear tempered glass and smoked or bronze stratified glass.
Seat upholstered in leather (see catalogue), padded with variable-density polyurethane foam.
Metal parts in a polished chrome finish.
- Sessel aus extrahellem Sicherheitsglas und Schichtglas Rauchfarbe oder Bronze.
Sitzfläche aus Leder (Siehe Kataloge), mit Polyurethanschaum in unterschiedlicher Dichte gepolstert.
Metallteile in poliertem Chrom.
- Fauteuil en verre trempé extra clair et en verre feuilleté fumé ou bronze.
Assise revêtue de cuir (voir catalogues 2026), rembourrée de mousse de polyuréthane à densité variable.
Éléments métalliques en chrome poli.

	I	dimensioni	spessore	volume	carico ammesso	peso	prezzo
	E	dimension	thickness	volume	admitted load	weight	price
	D	abmessungen	stärke	volumen	tragfähigkeit	gewicht	preis
	F	dimension	épaisseur	volume	charge admise	poids	prix
		cm	mm	m3	kg	kg	euro

comodini | comò | toeletta
bedside tables | dressers | dressing tables

	I E D F	dimensioni dimension abmessungen dimension	spessore thickness stärke épaisseur	volume volume volumen volume	carico ammesso admitted load tragfähigkeit charge admise	peso weight gewicht poids	prezzo price preis prix
		cm	mm	m3	kg	kg	euro

Comò alto Comò basso

design Marco Gaudenzi 1994

A	113 x 45 x h 65	10 / 12 / 15	0,623	70 + 20 *	108	□ 1.820
B	113 x 45 x h 40	10 / 12 / 15	0,350	80 + 20 *	69	□ 1.320

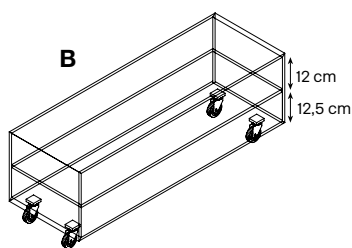
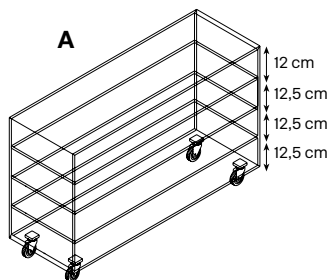

- * Ogni ripiano / On each shelf / Auf jedem Bord / Pour chaque étagère
□ vetro extrachiaro / extraclear glass / extrahelles glas / verre extra-claire

- Mobile multiuso su base con ruote.
- Glass-unit for various uses on castors.
- Mehrwertige Glaskommode auf Basis mit Rädern.
- Meuble à multiples emplois sur base avec roulettes.

Cassetti / Drawer / Schublade / Tiroir

U

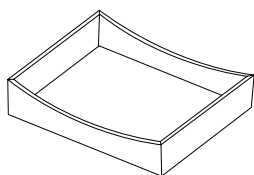

U 54,5 x 44,5 x h 12

Eucalipto Siberian Ash	0,068		5	380
noce canaletto canaletto walnut Walnuß canaletto noyer canaletto	0,068		5	380
RAL	0,068		5	360

H

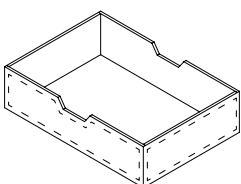

H 54,5 x 44,5 x h 12

Cassetto cuoio naturale o nero Natural or black leather drawer Schublade in Leder natur oder schwarz Tiroir en cuir naturel ou noir	0,068		5	580
--	-------	--	---	------------

	I	dimensioni	spessore	volume	carico ammesso	peso	prezzo
	E	dimension	thickness	volume	admitted load	weight	price
	D	abmessungen	stärke	volumen	tragfähigkeit	gewicht	preis
	F	dimension	épaisseur	volume	charge admise	poids	prix
		cm	mm	m3	kg	kg	euro

Liber D design Luca Papini 2013/2019	40x40xh 80	10 / 12	0,3	15 *	51	<input type="checkbox"/> 1.410
						<input checked="" type="checkbox"/> 1.480
						<input checked="" type="checkbox"/> 1.520

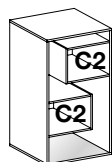

Optional CASSETTO C2 / Optional CASSETTO C2
Opzional CASSETTO C2 / Optionnel CASSETTO C2

- * ogni ripiano / on each shelf / auf jedem Bord / pour chaque étagère
- Vetro extrachiaro / extra clear glass / extrahelles Glas / verre extra clair
 - Vetro fumé / smoked glass / Rauchglas / verre fumé
 - Vetro bronzo / bronze glass / Bronze Glas / Verre bronze

Ripiano superiore cassetto in vetro acidato / laccato ral / vetro a specchio 80
 Top drawer shelf in frosted glass / ral lacquered glass / mirrored glass
 Glasplatte über Laden in geätzt/ral lackiertem / verspiegeltem Glas
 Étagère supérieur tiroir en verre mordancé / lacqué ral / miroir

- Libreria o espositore in vetro con base a specchio e piedini regolabili. Cassetti optional.
- Glass bookcase or showcase with mirrored base and adjustable feet. Optional drawers.
- Bücherregal oder Regal aus Glas mit verspiegeltem Boden und regelbaren Füßen. Optionale Schubladen.
- Bibliothèque ou présentoir en verre avec base en miroir e pieds réglables. Tiroirs optionnels.

Liber E-F design Luca Papini 2013/2019	E 40x40xh 40	10 / 12	0,14	15 *	30	<input type="checkbox"/> 1.020
						<input checked="" type="checkbox"/> 1.060
						<input checked="" type="checkbox"/> 1.090
	F 40x60xh 60	10 / 12	0,18	15 *	38	<input type="checkbox"/> 1.060
						<input checked="" type="checkbox"/> 1.110
						<input checked="" type="checkbox"/> 1.140

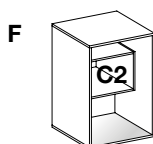
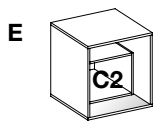

Optional CASSETTO C2 / Optional CASSETTO C2
Opzional CASSETTO C2 / Optionnel CASSETTO C2

- * ogni ripiano / on each shelf / auf jedem Bord / pour chaque étagère

- Vetro extrachiaro / extra clear glass / extrahelles Glas / verre extra clair
- Vetro fumé / smoked glass / Rauchglas / verre fumé
- Vetro bronzo / bronze glass / Bronze Glas / Verre bronze

Ripiano superiore cassetto in vetro acidato / laccato ral / vetro a specchio 80
 Top drawer shelf in frosted glass / ral lacquered glass / mirrored glass
 Glasplatte über Laden in geätzt/ral lackiertem / verspiegeltem Glas
 Étagère supérieur tiroir en verre mordancé / lacqué ral / miroir

- Fianco divano o comodino in vetro con base a specchio. Cassetti optional.
- End table or bed side table in glass with mirrored base. Optional drawers.
- Abstelltisch oder Nachttisch aus Glas mit Spiegelboden. Optionale Schubladen.
- Petite table ou chevet en verre avec base en miroir. Tiroirs optionnels.

	I E D F	dimensioni dimension abmessungen dimension	spessore thickness stärke épaisseur	volume volume volumen volume	carico ammesso admitted load tragfähigkeit charge admise	peso weight gewicht poids	prezzo price preis prix
		cm	mm	m3	kg	kg	euro
Liber G		80x40 x h 60	12 / 10	0,18	18 *	58	□ 1.450 ■ 1.500 ■ 1.560
		design Luca Papini 2015/2019					

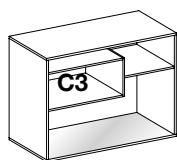

Optional CASSETTO C3 / Optional CASSETTO C3 / Opzional CASSETTO C3 / Optionnel CASSETTO C3

- * ogni ripiano / on each shelf / auf jedem Bord / pour chaque étagère
- Vetro extrachiaro / extra clear glass / extrahelles Glas / verre extra clair
- Vetro fumé / smoked glass / Rauchglas / verre fumé
- Vetro bronzo / bronze glass / Bronze Glas / Verre bronze

Ripiano superiore cassetto in vetro acidato / laccato ral / vetro a specchio Top drawer shelf in frosted glass / ral lacquered glass / mirrored glass Glasplatte über Laden in geätztem/ral lackiertem / verspiegeltem Glas Étagère supérieur tiroir en verre mordancé / lacqué ral / miroir	100
---	-----

- Fianco divano o comodino in vetro con base a specchio e piedini regolabili. Cassetti optional.
- End table or bed side table in glass with mirrored base. Optional drawers.
- Abstelltisch oder Nachttisch aus Glas mit Spiegelboden. Optionale Schubladen.
- Petite table ou chevet en verre avec base en miroir. Tiroirs optionnels.

Liber cassetto	C1 19 x 40 x h 25		0,03	15	2,5	● 290 ●● 300 ●●● 340 ●●●● 460	
	C2 25 x 40 x h 19		0,03	15	2,5	● 290 ●● 300 ●●● 340 ●●●● 460	
	C3 45 x 40 x h 19		0,06	15	4,5	● 330 ●● 340 ●●● 360 ●●●● 490	
		design Luca Papini 2013/2022					

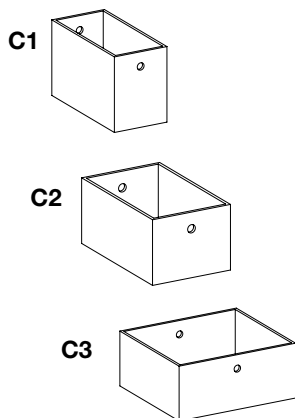

- Cassetto in legno laccato in finitura bianco opaco con foro bifacciale.
- Drawer in matt white lacquered wood with double sided opening.
- Schublade aus Holz matt weiß lackiert mit beidseitiger Öffnung.
- Tiroir en bois laqué mat blanc avec trou biface.

- Cassetto in legno laccato in finitura RAL opaco con foro bifacciale
- Drawer in matt RAL lacquered wood with double sided opening.
- Schublade aus Holz matt RAL lackiert mit beidseitiger Öffnung.
- Tiroir en bois laqué mat RAL avec trou biface.

- Cassetto in legno SIBERIAN ASH, EUCALIPTO e Noce Canaletto con maniglia in pelle.
- Wooden drawer in SIBERIAN ASH, EUCALIPTO and Canaletto Walnut with leather knob.
- Holzschublade aus SIBERIAN ASH, EUCALIPTO und Canaletto Walnuß mit Ledergriff.
- Tiroir en bois SIBERIAN ASH, EUCALIPTO et Noyer Canaletto avec pommeau en cuir.

- Cassetto in cuoio testa di moro con una maniglia.
- Drawer in dark leather with one handle.
- Schublade aus dunklem Leder mit einem Griff.
- Tiroir en cuir Tête-De-Maure avec un pommeau.

	I	dimensioni	spessore	volume	carico ammesso	peso	prezzo
	E	dimension	thickness	volume	admitted load	weight	price
	D	abmessungen	stärke	volumen	tragfähigkeit	gewicht	preis
	F	dimension	épaisseur	volume	charge admise	poids	prix
		cm	mm	m3	kg	kg	euro

Opalina toeletta

80 x 56 x h 130

12 / 4

0,612

40

68

□ 2.280

■ 2.770

■ 2.880

design Cristina Celestino 2016

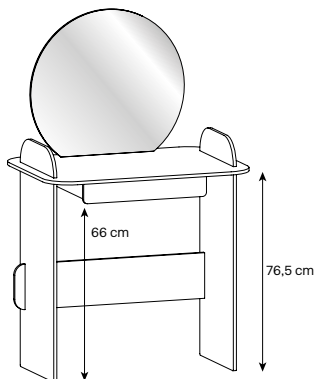

- Top extrachiaro satinato, fianchi extrachiaro e cassetto verniciato bianco
extra clear frosted top + extra clear sides + matt white lacquered wooden drawer
Top extrahell geätzt + Seiten extrahell + Schublade aus Holz matt weiß
top extra clair mordancé + cotés extra clair + tiroir en bois laqué blanc opaque
- Top e fianchi fumè, specchio fumè e cassetto in pelle
smoked top and sides + smoked mirror + leather drawer
Top und Seiten Rauchglas + Rauchglas Spiegel + Lederschublade
top et cotés en verre fumé + miroir fumé + tiroir cuir
- Top e fianchi bronzo, specchio bronzo e cassetto in pelle
bronze top and sides + bronze mirror + leather drawer
Top und Seiten Bronze Glas + Bronze Spiegel + Lederschublade
top et cotés en verre bronze + miroir bronze + tiroir cuir

- Toeletta con struttura in vetro extrachiaro satinato, fumè o bronzo.
Cassetto estraibile rivestito in pelle (vedi catalogo) e specchio in finitura specchio, fumè o bronzo in abbinamento.
- Console or dressing table with extra clear frosted glass, smoked or bronze glass structure.
Pull-out drawer covered in leather (see catalogue) and a matching mirror, clear, smoked or bronze finish.
- Konsole oder Frisiertisch mit Struktur aus extrahell geätztem Glas, Rauchglas oder Bronze Glas.
Ausziehbare Schublade aus Leder (siehe Katalog) und passendem Spiegel aus Klarglas, Rauchglas oder Bronze.
- Console ou coiffeuse avec structure en verre extra clair mordancé, fumé ou bronze.
Tiroir extractible recouvert en cuir (voir catalogue) et miroir assorti en finition clair, fumé ou bronze.

Opalina sgabello

Ø 38 x h 45

12

0,138

80

18

□ 630

■ 660

■ 680

design Cristina Celestino 2016



Cuscino in pelle / Cushion in leather / Kissen aus Leder / Coussin en cuir

380

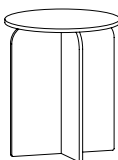

Vetro extrachiaro / extra clear glass / extrahelles Glas / verre extra clair
Vetro fumè / smoked glass / Rauchglas / verre fumé
Vetro bronzo / bronze glass / Bronze Glas / verre bronze

- Sgabello o fianco divano in vetro extra chiaro, fumè o bronzo. Optional cuscino in pelle vedi Catalogo.
- Stool or side table in extra clear, smoked or bronze glass. Optional cushion in leather, see Catalogue.
- Hocker oder Beistelltisch in extrahellem, Rauchglas oder Bronze Glas. Optionaler Kissen aus Leder, Siehe Katalog.
- Tabouret ou table de chevet en verre extra clair, fumé ou bronze. Optionnel coussin en cuir, voir catalogues.

carrelli | trolleys

	I	dimensioni	spessore	volume	carico ammesso	peso	prezzo
	E	dimension	thickness	volume	admitted load	weight	price
	D	abmessungen	stärke	volumen	tragfähigkeit	gewicht	preis
	F	dimension	épaisseur	volume	charge admise	poids	prix
		cm	mm	m3	kg	kg	euro

Grattacielo componibile

design Marco Gaudenzi,
Isao Hosoe, 1991/1993

58 x 45 x h 13

12

0,040

10

□ 360

A

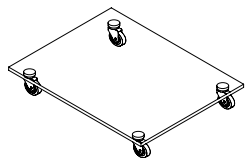

- Elemento: Base con ruote
- Component: Base Unit with castors
- Element: Grundelement mit Rollen
- Élément: Base avec roulettes

58 x 45 x h 13,5

12 / 15

0,040

11

□ 380

B

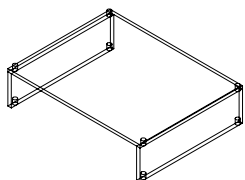

- Elemento: Intermedio semplice
- Component: Intermediate Unit
- Element: Einfaches Mittelelement
- Élément: Intermédiaire simple

58 x 45 x h 13,5

12 / 15

0,040

11

□ 370

C

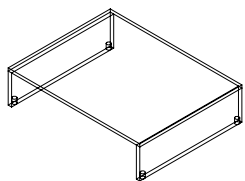

- Elemento: Terminale semplice
- Component: Top Unit
- Element: Einfaches Endelement
- Élément: Terminal simple

58 x 45 x h 25,5

12 / 15

0,080

20

□ 400

D

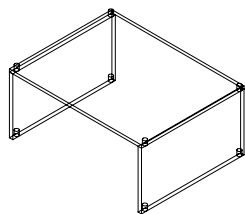

- Elemento: Intermedio doppio
- Component: Double Intermediate Unit
- Element: Doppeltes Mittelelement
- Élément: Intermédiaire double

58 x 45 x h 25,5

12 / 15

0,080

16

□ 390

E

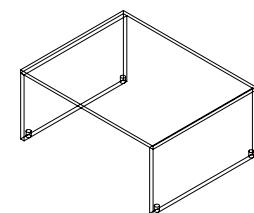

- Elemento: Terminale doppio
- Component: Double Top Unit
- Element: Doppeltes Endelement
- Élément: Terminal double

□ Vetro extrachiaro / extra clear glass / extrahelles Glas / verre extra clair

- Elementi in vetro 12 / 15 mm sovrapponibili, con perni di acciaio, su base munita di ruote gommate.
- 12 / 15 mm glass elements, superposition on a base, equipped with rubber castors.
- Elemente aus 12 / 15 mm Glass aufstapelbar auf Basis mit gummierten Rädern,
- Éléments en verre 12 / 15 mm, superposable sur base avec roulettes en caoutchouc.

Grattacielo componibile

design Marco Gaudenzi,
Isao Hosoe, 1991/1993

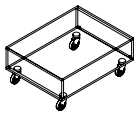

A + C
COMP. 1 h 26
□ 730

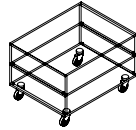

A + B + C
COMP. 2 h 40
□ 1.110

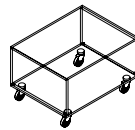

A + E
COMP. 3 h 39
□ 750

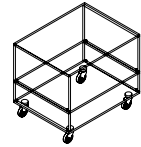

A + B + E
COMP. 4 h 52
□ 1.130

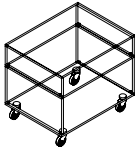

A + D + C
COMP. 5 h 52
□ 1.130

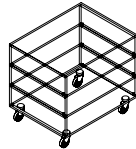

A + 2B + C
COMP. 6 h 54
□ 1.490

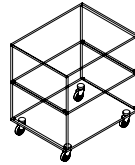

A + D + E
COMP. 7 h 64
□ 1.150

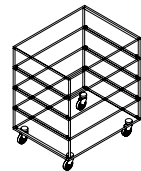

A + 3B + C
COMP. 8 h 67
□ 1.870



A + 2B + E
COMP. 9 h 66
□ 1.510

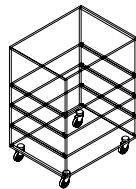

A + 3B + E
COMP. 10 h 79
□ 1.890

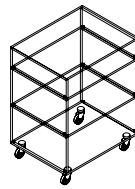

A+2D+C
COMP. 11 h 78
□ 1.530

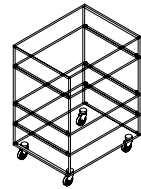

A+2B+D+C
COMP. 12 h 79
□ 1.890

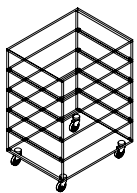

A+4B+C
COMP. 13 h 81
□ 2.250

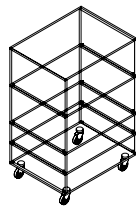

A+2B+D+E
COMP. 14 h 91
□ 1.910

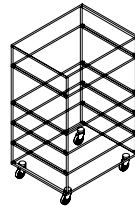

A+3B+D+C
COMP. 15 h 93
□ 2.270

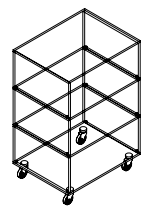

A+2D+E
COMP. 16 h 90
□ 1.550

□ Vetro extrachiario / extra clear glass / extrahelles Glas / Verre extra clair

Grattacielo Componibile / stackable Grattacielo / Stapelbare Grattacielo / Grattacielo composable

Cassetti 58 / Drawer 58 / Schublade 58 / Tiroir 58

U

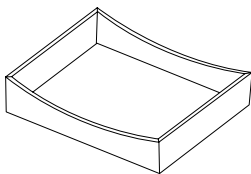

U 54,5 x 44,5 x h 12

Eucalipto Siberian Ash	0,068		5	380
noce canaletto canaletto walnut Walnuß canaletto noyer canaletto	0,068		5	380
RAL	0,068		5	360

H

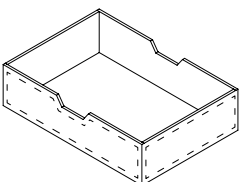

H 54,5 x 44,5 x h 12

Cassetto cuoio naturale o nero Natural or black leather drawer Schublade in Leder natur oder schwarz Tiroir en cuir naturel ou noir	0,068		5	580
--	-------	--	---	-----

	I	dimensioni	spessore	volume	carico ammesso	peso	prezzo
	E	dimension	thickness	volume	admitted load	weight	price
	D	abmessungen	stärke	volumen	tragfähigkeit	gewicht	preis
	F	dimension	épaisseur	volume	charge admise	poids	prix
		cm	mm	m3	kg	kg	euro

Grattacielo Fix 58/80

design Marco Gaudenzi,
Isao Hosoe, 1991/1993

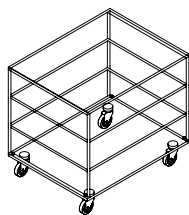

Comp. fix **6/a**
58 x 45 x h 52
□ **1.180**

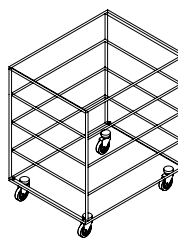

Comp. fix **8/a**
58 x 45 x h 66
□ **1.380**

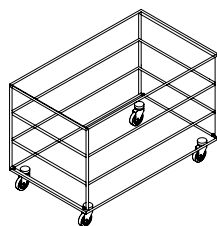

Comp. fix **6/d**
80 x 45 x h 52
□ **1.280**

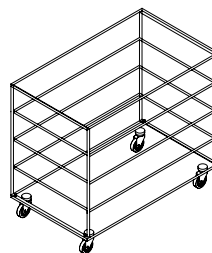

Comp. fix **8/d**
80 x 45 x h 66
□ **1.520**

□ Vetro extrachiaro / extra clear glass / extrahelles Glas / verre extra clair
Fisso non componibile / Fixed System / Fixiertes system / Systeme non superposable

- Carrello multiuso a struttura fissa su ruote.
- Fixed trolley-system on castors.
- Mehrwertiger wagen mit fixierte Struktur auf Rollen.
- Meuble à multiples emplois avec structure fixe sur roulettes.

Cassetti 58 / Drawer 58 / Schublade 58 / Tiroir 58

U

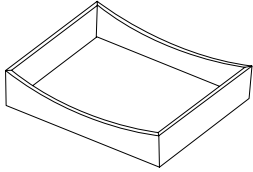

U 54,5 x 44,5 x h 12

Eucalipto Siberian Ash	0,068		5	380
noce canaletto canaletto walnut Walnuß canaletto noyer canaletto	0,068		5	380
RAL	0,068		5	360

H

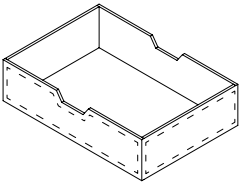

H 54,5 x 44,5 x h 12

Cassetto cuoio naturale o nero Natural or black leather drawer Schublade in Leder natur oder schwarz Tiroir en cuir naturel ou noir	0,068		5	580
--	-------	--	---	------------

vasi | planters

	I E D F	dimensioni dimension abmessungen dimension	spessore thickness stärke épaisseur	volume volume volumen volume	carico ammesso admitted load tragfähigkeit charge admise	peso weight gewicht poids	prezzo price preis prix
		cm	mm	m3	kg	kg	euro

Amon 1 design Roberto Garbugli 2008	58x58xh160		0,78		82	■ 2.060
						□ 2.220
						● 2.100
						●● 2.170
						●●● 2.180

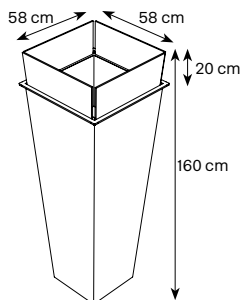

Amon 2 design Roberto Garbugli 2008	58x58xh120		0,58		62	■ 1.780
						□ 1.920
						● 1.820
						●● 1.880
						●●● 1.890

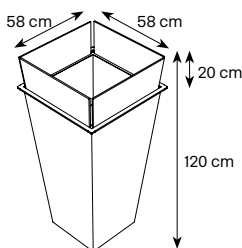

Amon 3 design Roberto Garbugli 2008	58x58xh80		0,38		54	■ 1.530
						□ 1.650
						● 1.560
						●● 1.610
						●●● 1.620

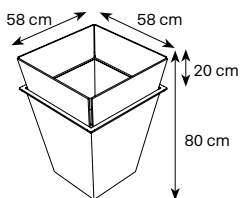

- Vetro laccato nero / Black lacquered glass / Schwarz lackiertes Glas / Verre lacqué noir
- Vetro laccato bianco / White lacquered glass / Weiss lackiertes Glas / Verre lacqué blanc
- Specchio / Mirror / Spiegel / Miroir
- Specchio fumè / Smoked mirror / Rauchglasspiegel / miroir fumé
- Specchio bronzo / Bronze mirror / Bronze Spiegel / Miroir bronze

- Vasi da interno con struttura in lamiera zincata rivestita in specchio, specchio fumè e bronzo. Cornice perimetrale in acciaio inox, vetri superiori extrachiaro, fumè o bronzo in abbinamento allo specchio sottostante.
- Indoor vases with a galvanized sheet metal structure covered in clear, smoked or bronze mirror. Stainless steel frame, extra-clear, smoked, or bronze upper glass to match the mirror below.
- Vasen für den Innenbereich mit einem Rahmen aus verzinktem Blech, der mit Klarglas, Rauchglas oder Bronze Glas Spiegel überzogen ist. Edelstahlrahmen am Rand, obere Glasteile aus extrahellem, Rauchglas oder Bronze Glas, passend zum darunterliegenden Spiegel.
- Vases d'intérieur avec une structure en tôle galvanisée recouverte de miroir clair, fumé ou bronze. Cadre périmétral en acier inoxydable, couvercles en verre extra clair, fumé ou bronze assortis au miroir.

Specificare sempre la finitura dei vetri superiori: extrachiaro, fumè o bronzo
Always specify upper glass finish: extra clear, smoked or bronze
Immer Ausfertigung der oberen Gläser angeben: extrahell, Rauchglas oder Bronze
Toujours spécifier finitions des verres supérieures: extra clair, fumé ou bronze

	I E D F	dimensioni dimension abmessungen dimension	spessore thickness stärke épaisseur	volume volume volumen volume	carico ammesso admitted load tragfähigkeit charge admise	peso weight gewicht poids	prezzo price preis prix
		cm	mm	m3	kg	kg	euro
Lingo		34 x 34 x h 70		0,2		28	● 760 ●● 780 ●●● 790
design Roberto Garbugli 2008							

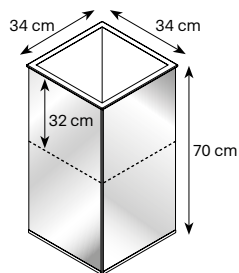

- Specchio / Mirror / Spiegel / Miroir
- Specchio fumè / Smoked mirror / Rauchglasspiegel / miroir fumé
- Specchio bronzo / Bronze mirror / Bronze Spiegel / Miroir bronze

- Vasi da interno con struttura interno in legno rivestita in specchio, specchio fumè e bronzo.
Cornice perimetrale superiore e inferiore in acciaio inox.

- Indoor vases with a wooden frame covered in clear, smoked and bronze mirror.
Upper and lower perimeter frames are made of stainless steel.

- Vasen für den Innenbereich mit Holzstruktur, die mit Klarglas, Rauchglas oder Bronze Glas Spiegel überzogen ist.
Unterer und oberer Rahmen aus Edelstahl.

- Vases d'intérieur à cadre en bois recouvert de miroir clair, fumé ou bronze.
Cadres périmétraux supérieur et inférieur en acier inoxydable.

rivestimenti | boiserie
wall coverings | boiserie

Wonderwall

design Massimo Castagna 2025

Esploso componenti sistema di rivestimenti pareti / Component details of wall covering system
Komponentendetails des Wandverkleidungssystem / Détail des composants du système de revêtement mural

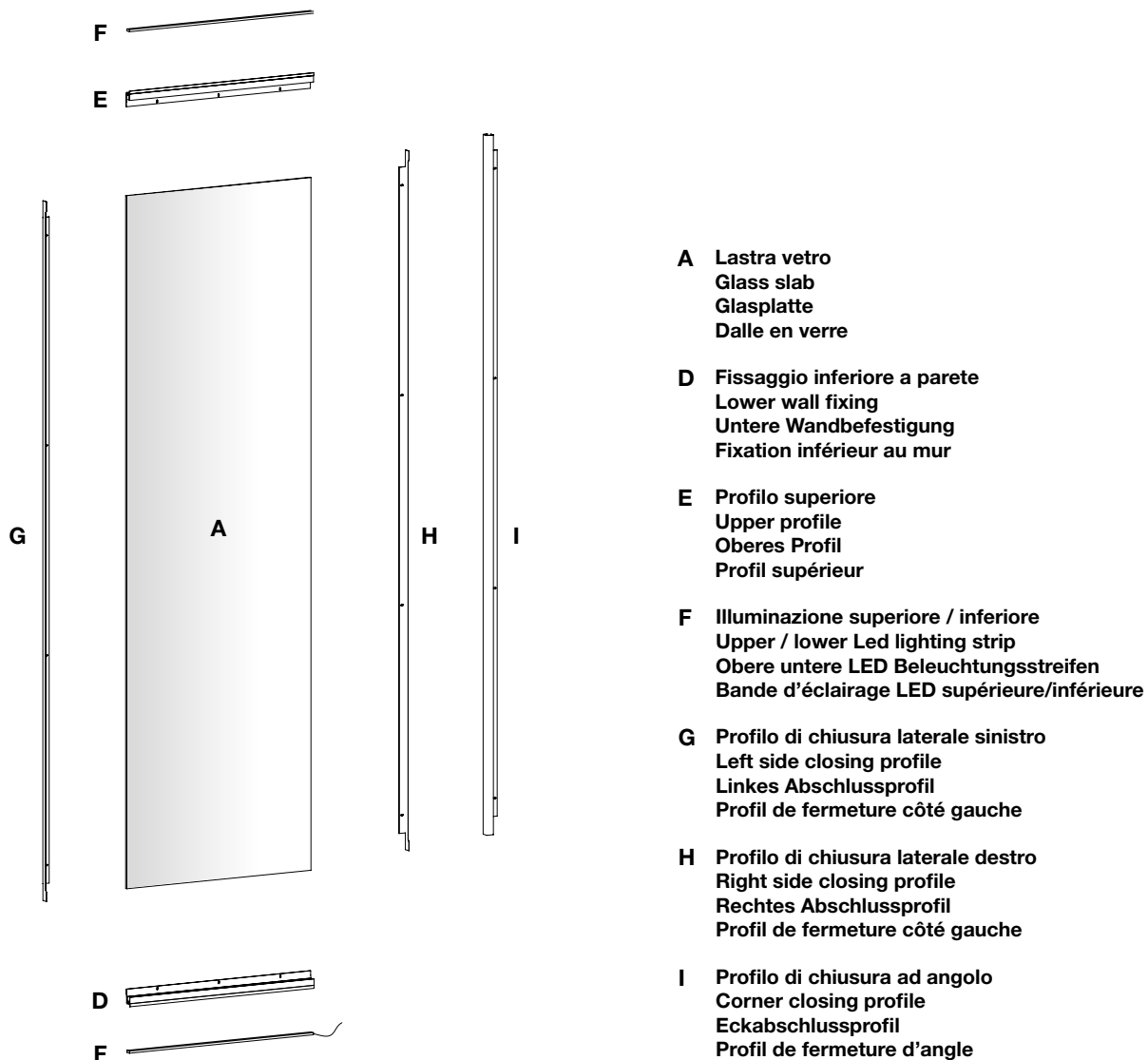

- Sistema di rivestimenti per pareti in vetro fuso temperato con profili di fissaggio in metallo. Finiture: Nero, Carbon, Bronzo, Rame, Champagne e Sabbia.
Le composizioni possono essere completate con profili di chiusura laterali verticali e ad angolo.

Sistema realizzabile su misura con moduli di dimensione massima pari a 300 cm in altezza e 90 cm in larghezza.

È possibile realizzare forature e asole passanti, previa richiesta all'ufficio vendite.

- Wall covering system in tempered fused glass with fixing profiles in metal. Finishes: Nero, Carbon, Bronzo, Rame, Champagne e Sabbia.

The compositions can be completed with vertical and corner lateral closing profiles.

System that can be made to measure with modules of maximum size 300 cm in height and 90 cm in width.

It is possible to implement with holes and outlets, upon request to the sales office.

- Wandverkleidungssystem aus gehärtetem Schmelzglas mit Befestigungsprofilen aus Metall in Ausführung Nero, Carbon, Bronzo, Rame, Champagne e Sabbia.

Die Kompositionen können mit vertikalen und seitlichen Eckabschlussprofilen vervollständigt werden.

Maßgefertigtes System mit Modulen von maximal 300 cm Höhe und 90 cm Breite.

Auf Anfrage beim Verkaufsbüro ist die Anbringung von Löchern und Durchgangsschlitzen möglich.

- Système de revêtement mural en verre trempé fusionné avec profils de fixation en métal. Finitions: Nero, Carbon, Bronzo, Rame, Champagne e Sabbia.

Les compositions peuvent être complétées par des profils de fermeture latéraux verticaux et d'angle.

Système réalisable sur mesure avec des modules de dimensions maximales de 300 cm de hauteur et 90 cm de largeur.

Il est possible de réaliser des trous et des fentes traversantes, sur demande auprès du bureau commercial.

Wonderwall

design Massimo Castagna 2025

Sistema di aggancio / Wall hooking system

Sistema semplice ed intuitivo di aggancio a muro, con attaccaglie reggipensili; una corretta distribuzione dei sistemi di aggancio consente l'allineamento dei pannelli tra di loro. Eventuali problemi della muratura, possono essere corretti spessorando i sistemi di aggancio.

Simple and intuitive wall hooking system with wall hangers. A correct distribution of the coupling systems allows to align the panels with each other. Any masonry problems can be corrected by shimming the hooking systems.

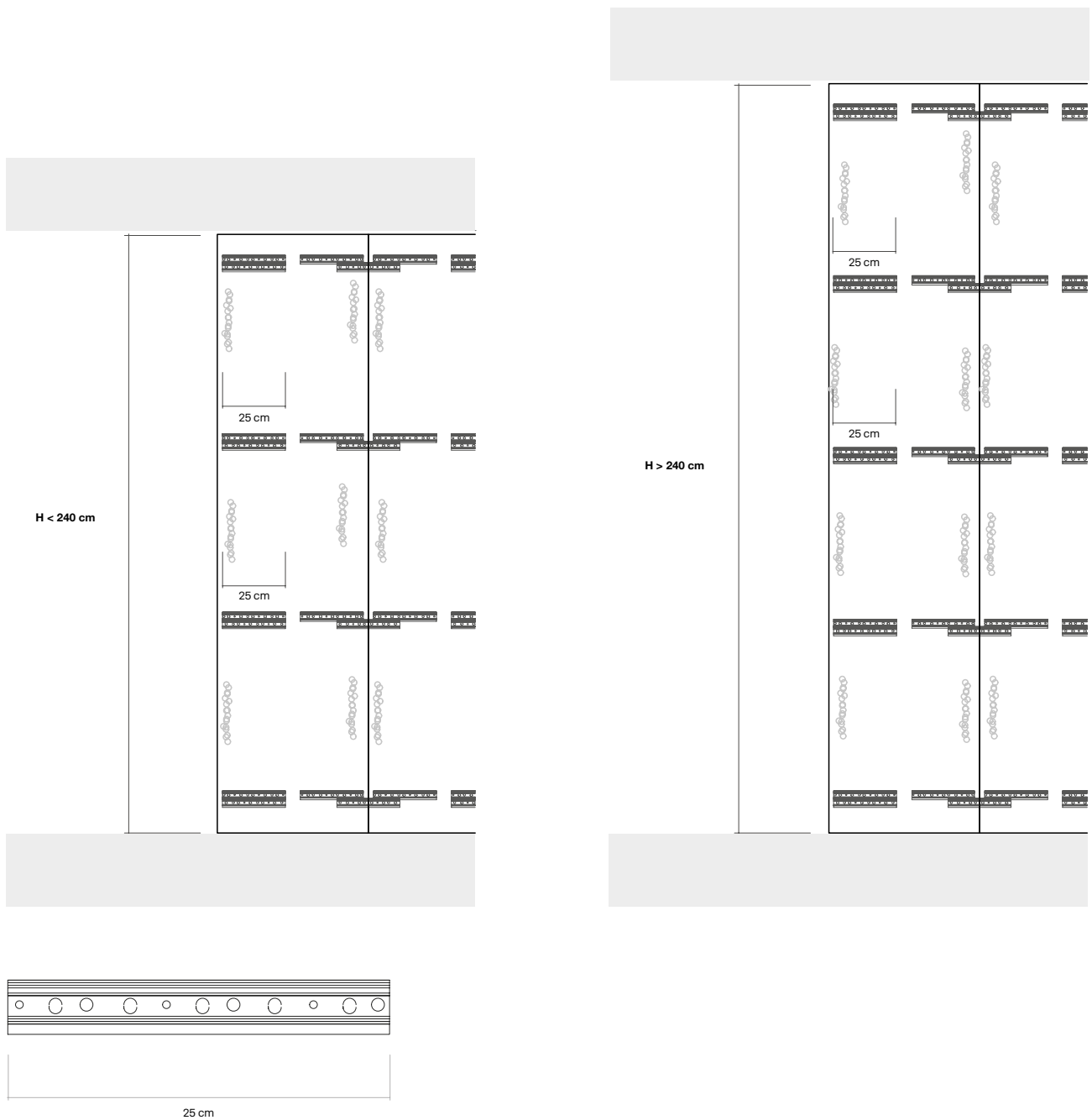

Sistema realizzabile su misura con moduli di dimensione massima pari a 300 cm in altezza e 90 cm in larghezza.
System that can be made to measure with modules of maximum size 300 cm in height and 90 cm in width.
Maßgefertigtes System mit Modulen von maximal 300 cm Höhe und 90 cm Breite.
Système réalisable sur mesure avec des modules de dimensions maximales de 300 cm de hauteur et 90 cm de largeur.

Wonderwall

design Massimo Castagna 2025

Lastra vetro / Glass slab / Glasplatte / Dalle en verre

A

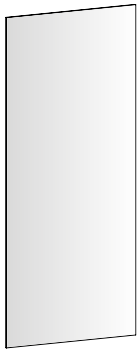

Vetro extrachiaro specchio / extra clear glass mirror
Spiegel extrahelles Glas / verre extra clair miroir

Vetro fumè specchio / smoked glass mirror
Spiegel Rauchglas / verre fumé miroir

Vetro bronzo specchio / bronze glass mirror
Spiegel Bronze Glas / verre bronze miroir

Vetro extrachiaro retrolaccato RAL / extra clear glass backlacquered RAL
extrahelles Glas mit RAL Hinterlackierung / verre extra clair lacquage arrière RAL

980 euro/mq

Specificare sempre la texture della lastra di vetro T-Squares o T-Stripes.
Always specify texture of glass slab T-Squares or T-Stripes.
Immer Textur der Glasscheiben angeben T-Squares oder T-Stripes.
Toujours indiquer texture des dalles en verre T-Squares ou T-Stripes.

La fornitura minima è di 6 mq per ogni texture.
Minimum quantity 6 m2 for each texture.
Mindestmenge 6 m2 für jede Textur.
Quantité minimal 6 m2 pour chaque texture.

Elementi di fissaggio / Fixing elements / Befestigungselemente / Éléments de fixation

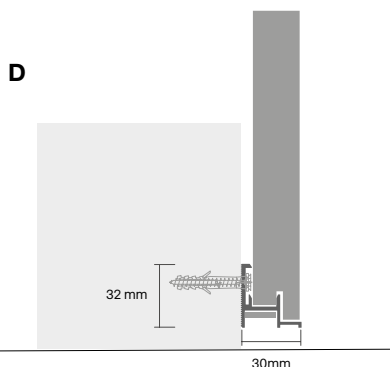

Fissaggio inferiore a parete
Lower wall fixing
Untere Wandbefestigung
Fixation inférieur au mur

270 euro/ml

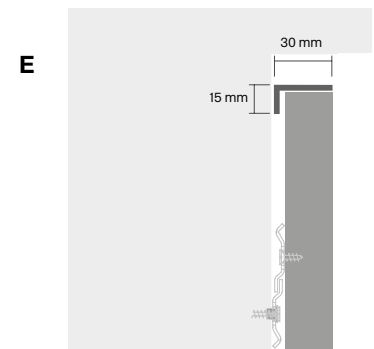

Profilo superiore
Upper profile
Oberes Profil
Profil supérieur

190 euro/ml

Il prezzo della soluzione si calcola sommando:

Price calculation:

A Superficie da rivestire x prezzo boiserie al m2 Surface to be covered x wall paneling price per square meter	980 euro/mq
D Fissaggio inferiore a parete Lower wall fixing	270 euro/ml
E Profilo superiore Upper profile	190 euro/ml
I Profilo angolare opzionale Corner profile (optional)	120 euro/ml
G/H Terminale End profile	90 euro/ml
F Kit illuminazione Lighting kit	180 euro/ml
Disegno esecutivo Shopdrawing	100 euro prezzo netto / net price

Wonderwall

design Massimo Castagna 2025

Optionals / Optionals / Optionalelemente / Options

G

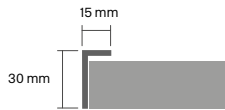

Profilo di chiusura laterale sinistro
Left side closing profile
Linkes Abschlussprofil
Profil de fermeture côté gauche

90 euro/ml

H

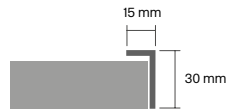

Profilo di chiusura laterale destro
Right side closing profile
Rechtes Abschlussprofil
Profil de fermeture côté droite

90 euro/ml

I

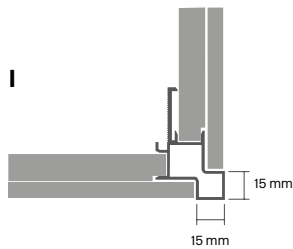

Profilo di chiusura ad angolo
Corner closing profile
Eckabschlussprofil
Profil de fermeture d'angle

120 euro/ml

F

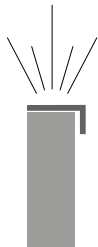

Illuminazione superiore / inferiore
Upper / lower Led lighting strip
Obere untere LED Beleuchtungsstreifen
Bande d'éclairage LED supérieure/inférieure

180 euro/ml

- Kit illuminazione strip LED superiore e/o inferiore.
Luce LED dimmerabile 3000K. Considerare sempre uno spazio tecnico utile per alloggiare l'alimentatore di 30x30x5cm.
È possibile richiedere il telecomando per l'accensione dell'illuminazione strip LED.
- Upper and/or lower LED strip lighting kit.
3000K dimmable LED light. Always consider a useful technical space to house the 30x30x5cm power supply.
It is possible to request the remote control to turn on the LED strip lighting.
- Obere und/oder untere LED-Streifenbeleuchtungsset.
Dimmbares LED-Licht 3000K. Berücksichtigen Sie für die Unterbringung des Netzteils immer einen nutzbaren technischen Raum von 30 x 30 x 5 cm. Es besteht die Möglichkeit, die LED-Streifenbeleuchtung über die Fernbedienung anzufordern.
- Kit d'éclairage à bande LED supérieure et/ou inférieure.
Lumière LED à intensité variable 3000K. Prévoyez toujours un espace technique utile pour loger l'alimentation de 30x30x5cm.
Il est possible de demander la télécommande pour allumer l'éclairage de la bande LED.

Wonderwall

design Massimo Castagna 2025

Esempi di composizioni / composition examples
Kompositionsbeispiele / exemples de compositions

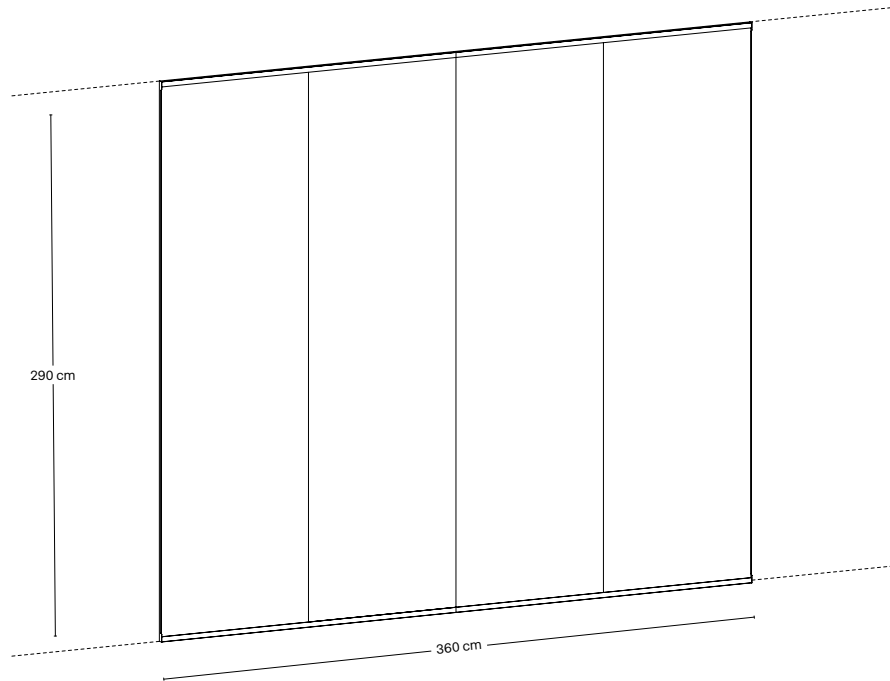

- | | |
|--|--|
| A Lastra vetro T-Squares Extrachiaro Specchio
Glass slab extraclear T-Squares mirror
Extrahelle Glassscheibe T-Squares Spiegel
Dalle de verre extra clair miroir T-Squares | $2.9 \times 3.6 \text{ m} = 10.44 \text{ mq} \times 980 \text{ euro/mq} = 10.231 \text{ euro}$ |
| D Fissaggio inferiore
Lower fixing
Untere Befestigung
Fixation inférieure | $3.6 \text{ m} \times 270 \text{ euro/ml} = 972 \text{ euro}$ |
| E Profilo superiore
Upper profile
Oberes Profil
Profil supérieur | $3.6 \text{ m} \times 190 \text{ euro/ml} = 684 \text{ euro}$ |
| G Profilo di chiusura laterale sinistro
Left side closing profile
Linkes Abschlussprofil
Profil de fermeture côté gauche | $2.9 \text{ m} \times 90 \text{ euro/ml} = 261 \text{ euro}$ |
| H Profilo di chiusura laterale destro
Right side closing profile
Rechtes Abschlussprofil
Profil de fermeture côté gauche | $2.9 \text{ m} \times 90 \text{ euro/ml} = 261 \text{ euro}$ |

Tot. **12.409** euro

Wonderwall

design Massimo Castagna 2025

Esempi di composizioni / composition examples
Kompositionsbeispiele / exemples de compositions

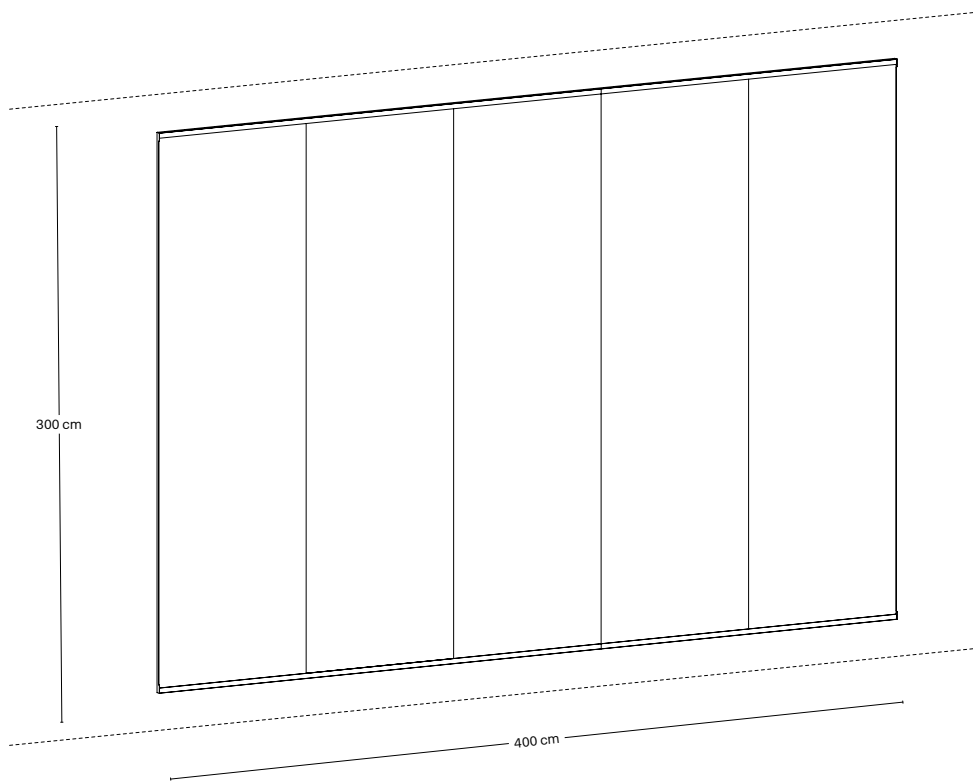

- | | |
|---|---|
| A Lastra vetro T-Stripes Fumè Specchio
Glass slab extraclear T-Squares mirror
Extrahelle Glassscheibe T-Squares Spiegel
Dalle de verre extra clair miroir T-Squares | 3x4 m = 12 mq x 980 euro/mq = 11.760 euro |
| D Fissaggio inferiore
Lower fixing
Untere Befestigung
Fixation inférieure | 4 m x 270 euro/ml = 1.080 euro |
| E Profilo superiore
Upper profile
Oberes Profil
Profil supérieur | 4 m x 190 euro/ml = 760 euro |
| G Profilo di chiusura laterale sinistro
Left side closing profile
Linkes Abschlussprofil
Profil de fermeture côté gauche | 3 m x 90 euro/ml = 270 euro |
| H Profilo di chiusura laterale destro
Right side closing profile
Rechtes Abschlussprofil
Profil de fermeture côté gauche | 3 m x 90 euro/ml = 270 euro |
| F Illuminazione superiore / inferiore
Upper / lower Led lighting strip
Obere untere LED Beleuchtungsstreifen
Bande d'éclairage LED supérieure/inférieure | 4 m x 180 euro/ml = 720 euro |
| F Illuminazione superiore / inferiore
Upper / lower Led lighting strip
Obere untere LED Beleuchtungsstreifen
Bande d'éclairage LED supérieure/inférieure | 4 m x 180 euro/ml = 720 euro |

Tot. **15.580** euro

Wonderwall

design Massimo Castagna 2025

Esploso componenti sistema di rivestimenti pareti / Component details of wall covering system
Komponentendetails des Wandverkleidungssystem / Détail des composants du système de revêtement mural

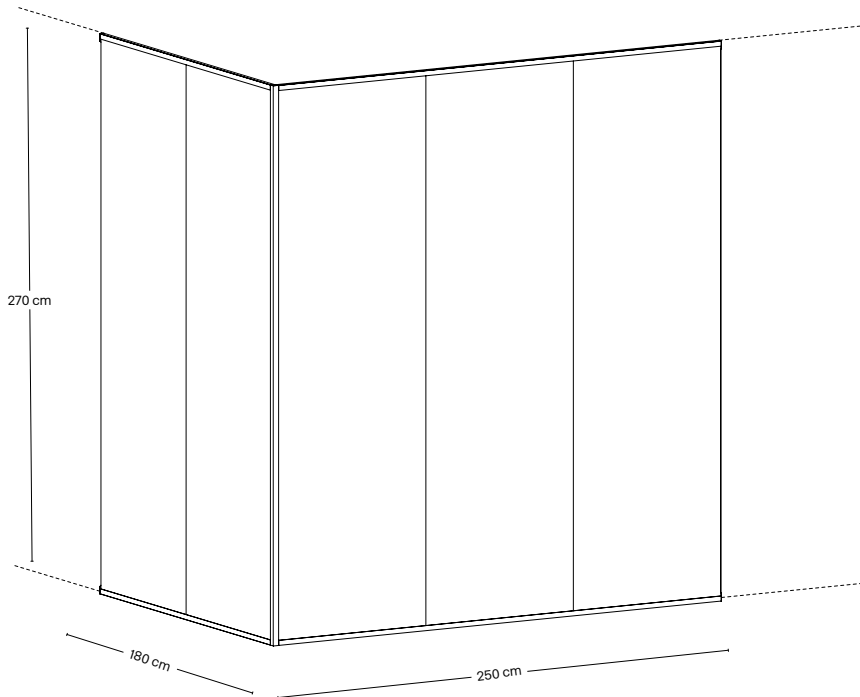

- | | |
|---|--|
| A Lastra vetro T-Stripes Bronzo Specchio
Bronze glass slab T-Stripes mirror
Bronze Glasscheibe T-Stripes Spiegel
Dalle en verre bronze T-Stripes miroir | $2.7 \text{ m} \times (1.8+2.5 \text{ m}) = 11.61 \text{ mq} \times 980 \text{ euro/mq} = 11.378 \text{ euro}$ |
| D Fissaggio inferiore
Lower fixing
Untere Befestigung
Fixation inférieure | $(1.8+2.5 \text{ m}) = 4,3 \text{ m} \times 270 \text{ euro/ml} = 1.161 \text{ euro}$ |
| E Profilo superiore
Upper profile
Oberes Profil
Profil supérieur | $(1.8+2.5 \text{ m}) = 4,3 \text{ m} \times 190 \text{ euro/ml} = 817 \text{ euro}$ |
| G Profilo di chiusura laterale sinistro
Left side closing profile
Linkes Abschlussprofil
Profil de fermeture côté gauche | $2.7 \text{ m} \times 90 \text{ euro/ml} = 243 \text{ euro}$ |
| H Profilo di chiusura laterale destro
Right side closing profile
Rechtes Abschlussprofil
Profil de fermeture côté gauche | $2.7 \text{ m} \times 90 \text{ euro/ml} = 243 \text{ euro}$ |
| I Profilo di chiusura ad angolo
Corner closing profile
Eckabschlussprofil
Profil de fermeture d'angle | $2.7 \text{ m} \times 120 \text{ euro/ml} = 324 \text{ euro}$ |

Tot. **14.166** euro

Tonellidesign

Tonelli Design

T.D. Srl

via Casali 40/42

61122 - Pesaro (PU) Italy

tel. +39 0721 481172

www.tonellidesign.it

info@tonellidesign.it

export@tonellidesign.it

-  Tonelli design
-  Tonelli_Design
-  tonelli-design
-  Tonelli Design - Official