

Tonellidesign

2023 / EU / Listino Prezzi / Price List

Listino Prezzi 2023 in ordine alfabetico

CONDIZIONI DI VENDITA PER L'ITALIA

Prezzi al pubblico I.V.A. esclusa

Le seguenti condizioni di vendita vengono accettate dall'acquirente con il conferimento dell'ordine.

Accettazione dell'ordine

L'ordine di acquisto dei prodotti del presente listino è subordinato all'approvazione e all'accettazione da parte di Tonelli Design

Ordini

Tutti gli ordini vengono confermati da Tonelli Design. Si raccomanda un attento controllo della conferma da parte del Cliente e l'immediata segnalazione di eventuali errori.

Preventivi

L'ordine viene disegnato da Tonelli Design e trasmesso al Cliente. Per confermare il preventivo il Cliente deve restituire il disegno apponendo timbro e firma per accettazione e conferma.

Prezzi

I valori sono espressi in Euro.

L'azienda si riserva la facoltà di variare il listino prezzi senza preavviso. Il presente listino prezzi annulla e sostituisce tutti i precedenti.

Annullamento e modifica dell'ordine

Tonelli Design si riserva la facoltà di rifiutare l'annullamento di un ordine dopo il ricevimento della conferma dell'ordine. Per gli articoli prodotti sarà addebitato il 100% del prezzo concordato della merce annullata o modificata. Per quelli in corso di produzione, un costo comunque non inferiore al 50% del prezzo di listino della merce.

Data di spedizione

La data di spedizione indicata sulla nostra conferma d'ordine ha valore semplicemente indicativo. Cause di forza maggiore possono a volte impedirci di rispettare le scadenze indicate. L'eventuale ritardo di consegna non potrà per nessun motivo dare adito all'annullamento totale o parziale dell'ordine, né ad azioni di rivalsa e/o risarcimento nei confronti di Tonelli Design.

Trasporti

La merce viene consegnata esclusivamente presso la sede del rivenditore **per ordini di importo netto superiore a euro 1.000,00.**

Per ordini di valore inferiore sarà addebitata una compartecipazione trasporto di euro 50,00.

La merce viaggia a mezzo corriere, al ricevimento si raccomanda un attento controllo dei colli e del loro numero.

Reclami

Dovranno essere segnalati per iscritto da parte del Cliente entro 7 giorni dal ricevimento della merce.

E' indispensabile: apporre riserva scritta sulla bolla di accompagnamento (sia sulla copia del vettore sia su quella del destinatario). La riserva scritta dovrà essere dettagliata indicando specificatamente la motivazione, ai fine di una corretta evasione della pratica di reclamo, non è sufficiente la sola riserva generica.

Inviare una mail con il seguente materiale:

- 1) foto chiara della parte danneggiata o non conforme;
- 2) numero ddt e descrizione dettagliata del reclamo

La merce difettosa verrà riparata o sostituita ad insindacabile giudizio dell'Azienda. E' escluso qualsiasi indennizzo per danni e spese collegati al reclamo.

Resi

Non si accettano resi se non preventivamente autorizzati.

Pagamenti

Le modalità di pagamento sono indicate nella conferma d'ordine. La non osservanza dei termini di pagamento comporta l'addebito degli interessi di mora. Eventuali inadempienze nei pagamenti autorizzano l'Azienda a sospendere la produzione della merce in ordine e a richiedere il saldo anticipato per le forniture in corso e future. L'Azienda si riserva il diritto di proprietà sulla merce fino all'avvenuto pagamento integrale della fornitura.

Tolleranze

Le misure indicate sul presente listino possono subire lievi modifiche dovute a problemi produttivi.

Colori

I colori del campionario sono indicativi. Confermando un ordine il Cliente accetta le eventuali tolleranze di colori e finiture.

Foro competente

Le controversie aventi origine dalle forniture saranno di competenza esclusiva del Foro di Pesaro.

Price List 2023 alphabetic order

SALES CONDITIONS (OTHER COUNTRIES)

Public prices, VAT duties and taxes not included

The following sales conditions are automatically accepted by the customer sending the order.

Order acceptance

The order of the goods in this price list is subject to the approval and acceptance by Tonelli design.

Orders

All orders must be confirmed by Tonelli design. Please carefully check the order confirmation and advise immediately about possible mistakes.

Offers

Drawings of the goods ordered are designed by Tonelli design and sent to customer. To confirm the offer, the customer must send back the drawing duly signed as approved and confirmed.

Prices

Values are in Euro.

Tonelli design reserves the right to change the price list without any previous notice. This price list cancels and replaces all previous ones.

Order cancellation and modification

Tonelli design can refuse to cancel an order after the receipt of the order confirmation. For goods already produced Tonelli design will charge 100% of the order value. For goods not yet finished but in production a charge not lower than 50% of the agreed upon price will be charged.

Shipment date

The shipment dates indicated in our order confirmations are approximate and not binding. Force majeure may prevent us from complying with the indicated deadlines. Possible delays in shipment can under no circumstances give cause to total or partial cancelation of the order, nor to any request of compensation from Tonelli design.

Transport

Please refer to the conditions agreed for your local area.

Claims

Possible claims must be transmitted by customer within 7 days from delivery of goods. It is essential to: expressly formulate a written reserve on the packing list or delivery note (both on shipper's and recipient's copy). The reserve shall be written in detail with a specific explanation, so as to allow a correct processing of the claim. Send an e-mail with the following material:

- 1) clear picture of the damaged or non-compliant part;
- 2) original order n. and detailed description of the claim.

Faulty goods will be repaired or replaced at the sole discretion of Tonelli design. Any compensation for damages and collateral costs linked to the claim are excluded.

Returns

Only the returns of goods previously authorised by Tonelli design will be accepted.

Payments

Payment terms are indicated in the order confirmation.

Any delay in payment will automatically imply the charge of interests on arrears. Moreover, Tonelli design is authorised to stop the production of goods ordered.

The goods are in any case property of Tonelli design until all payments have been received.

Tolerances

The measures indicated in the price list may be subject to slight changes due to production issues.

Colours

Sample colours are indicative. By confirming an order, the customer automatically accepts slight changes in colours and finishes.

Governing law and competent court

All sales subject to the present conditions are governed by Italian law. Any disputes originating from the supply are under the jurisdiction of the Pesaro Court in Italy.

Tonellidesign

	I E D F	dimensioni dimension abmessungen dimension	spessore thickness stärke épaisseur	volume volume volumen volume	carico ammesso admitted load tragfähigkeit charge admise	peso weight gewicht poids		prezzo price preis prix
		cm	mm	m3	kg	kg		euro

After9

design Massimo Castagna 2020

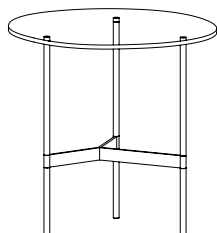

50 x 50 x h 30	10	0,059	20	13	□	1.390
					■	1.400
					■	1.410

50 x 50 x h 40	10	0,059	20	13	□	1.410
					■	1.420
					■	1.430

50 x 50 x h 50	10	0,059	20	13	□	1.430
					■	1.440
					■	1.450

- top vetro extrachiaro / extra clear glass top / Top aus extrahellem Glas / top verre extra clair
 ■ top vetro fumè / smoked glass top / Top aus Rauchglas / top verre fumé
 ■ top vetro bronzo / bronze glass top / Top aus Bronze Glas / top verre bronze

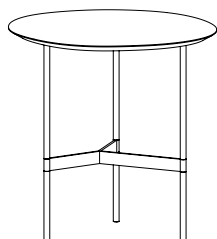

50 x 50 x h 31	16	0,059	20	11	●	1.480
					●●	1.470

50 x 50 x h 41	16	0,059	20	11	●	1.500
					●●	1.490

50 x 50 x h 51	16	0,059	20	11	●	1.520
					●●	1.510

- top legno Siberian Ash / Siberian Ash wood top / Holztop Siberian Ash / top bois Siberian Ash
 ●● top legno Eucalipto / Eucalipto wood top / Holztop Eucalipto / top bois Eucalipto

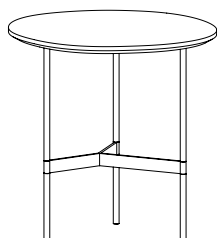

50 x 50 x h 31	20	0,059	20	18	▲	1.750
					▲▲	2.320
					▲▲▲	2.390

50 x 50 x h 41	20	0,059	20	18	▲	1.770
					▲▲	2.350
					▲▲▲	2.410

50 x 50 x h 51	20	0,059	20	18	▲	1.790
					▲▲	2.370
					▲▲▲	2.430

- ▲ top marmo Arabescato Orobico Gold / marble top Arabescato Orobico Gold
 Marmortop Arabescato Orobico Gold / top marbre Arabescato Orobico Gold
 ▲▲ top marmo Tropikal Storm / marble top Tropikal Storm
 Marmortop Tropikal Storm / top marbre Tropikal Storm
 ▲▲▲ top marmo Domus White / marble top Domus White
 Marmortop Domus White / top marbre Domus White

**Specificare sempre la finitura del basamento in metallo / always specify finish of metal base
 Immer Ausführung des Metallgestell angeben / indiquer toujours finition de la base en métal**

- Tavolo basso e fianco divano con struttura in metallo. Supporto superiore, disponibile solo in acciaio inox lucidato, telaio e supporto inferiore, disponibili nelle finiture: cromato, oro, rame, canna di fucile, lucide o spazzolate. Top in vetro (extrachiaro, fumè o bronzo), legno (Siberian Ash o Eucalipto) o marmo **SPAZZOLATO OPACO** (Arabescato Orobico Gold, Tropikal Storm o Domus White).
 - Low table and side table with metal structure. Upper support available only in polished stainless steel, frame and lower support available in following finishes: chrome, gold, copper, gunmetal, polished or brushed. Top in glass (extra clear, smoked or bronze), wood (Siberian Ash or Eucalipto) or **BRUSHED MATT** marble (Arabescato Orobico Gold, Tropikal Storm or Domus White).
 - Couchtisch und Beistelltisch mit Metallstruktur. Oberes Gestell nur in poliertem Edelstahl, unteres Gestell in folgenden Ausführungen: verchromt, gold, Kupfer, gunmetal, glänzend oder gebürstet. Top aus Glas (extrahell, Rauchglas oder bronze), Holz (Siberian Ash oder Eucalipto) oder **MATT GEBÜRSTETEM** Marmor (Arabescato Orobico Gold, Tropikal Storm oder Domus White).
 - Table bas et table de chevet avec structure en métal. Support supérieur disponible seulement en acier inox. Armature et support inférieur disponible en finition : chrome, or, cuivre, gunmetal, brillant ou brossé. Top en verre (extra clair, fumé ou bronze), bois (Siberian Ash ou Eucalipto) ou marbre **BROSSÉ MATT** (Arabescato Orobico Gold, Tropikal Storm ou Domus White).

	I E D F	dimensioni dimension abmessungen dimension	spessore thickness stärke épaisseur	volume volume volumen volume	carico ammesso admitted load tragfähigkeit charge admise	peso weight gewicht poids	prezzo price preis prix
		cm	mm	m3	kg	kg	euro

After9

design Massimo Castagna 2020

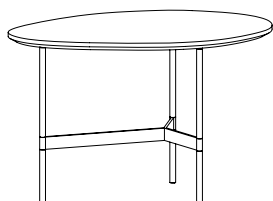
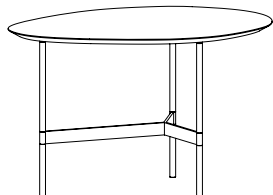
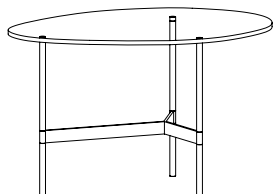

65 x 45 x h 30	10	0,064	20	15	□	1.450
					■	1.460
					■	1.470
65 x 45 x h 40	10	0,064	20	15	□	1.470
					■	1.480
					■	1.490
65 x 45 x h 50	10	0,064	20	15	□	1.490
					■	1.500
					■	1.510
□ top vetro extrachiaro / extra clear glass top / Top aus extrahellem Glas / top verre extra clair						
■ top vetro fumè / smoked glass top / Top aus Rauchglas / top verre fumé						
■ top vetro bronzo / bronze glass top / Top aus Bronze Glas / top verre bronze						
65 x 45 x h 31	16	0,064	20	12	●	1.610
					●●	1.600
65 x 45 x h 41	16	0,064	20	12	●	1.630
					●●	1.620
65 x 45 x h 51	16	0,064	20	12	●	1.650
					●●	1.640
● top legno Siberian Ash / Siberian Ash wood top/ Holztop Siberian Ash / top bois Siberian Ash						
●● top legno Eucalipto / Eucalipto wood top/ Holztop Eucalipto / top bois Eucalipto						
65 x 45 x h 31	20	0,064	20	21	▲	1.820
					▲▲	2.390
					▲▲▲	2.460
65 x 45 x h 41	20	0,064	20	21	▲	1.840
					▲▲	2.410
					▲▲▲	2.480
65 x 45 x h 51	20	0,064	20	21	▲	1.860
					▲▲	2.430
					▲▲▲	2.500
▲ top marmo Arabescato Orobico Gold / marble top Arabescato Orobico Gold Marmortop Arabescato Orobico Gold / top marbre Arabescato Orobico Gold						
▲▲ top marmo Tropikal Storm / marble top Tropikal Storm Marmortop Tropikal Storm / top marbre Tropikal Storm						
▲▲▲ top marmo Domus White / marble top Domus White Marmortop Domus White / top marbre Domus White						

**Specificare sempre la finitura del basamento in metallo / always specify finish of metal base
Immer Ausführung des Metallgestell angeben / indiquer toujours finition de la base en métal**

- Tavolo basso e fianco divano con struttura in metallo. Supporto superiore, disponibile solo in acciaio inox lucidato, telaio e supporto inferiore, disponibili nelle finiture: cromato, oro, rame, canna di fucile, lucide o spazzolate. Top in vetro (extrachiaro, fumè o bronzo), legno (Siberian Ash o Eucalipto) o marmo **SPAZZOLATO OPACO** (Arabescato Orobico Gold, Tropikal Storm o Domus White).
- Low table and side table with metal structure. Upper support available only in polished stainless steel, frame and lower support available in following finishes: chrome, gold, copper, gunmetal, polished or brushed. Top in glass (extra clear, smoked or bronze), wood (Siberian Ash or Eucalipto) or **BRUSHED MATT** marble (Arabescato Orobico Gold, Tropikal Storm or Domus White).
- Couchtisch und Beistelltisch mit Metallstruktur. Oberes Gestell nur in poliertem Edelstahl, unteres Gestell in folgenden Ausführungen: verchromt, gold, Kupfer, gunmetal, glänzend oder gebürstet. Top aus Glas (extrahell, Rauchglas oder bronze), Holz (Siberian Ash oder Eucalipto) oder **MATT GEBÜRSTETEM** Marmor (Arabescato Orobico Gold, Tropikal Storm oder Domus White).
- Table bas et table de chevet avec structure en métal. Support supérieur disponible seulement en acier inox. Armature et support inférieur disponible en finition : chrome, or, cuivre, gunmetal, brillant ou brossé. Top en verre (extra clair, fumé ou bronze), bois (Siberian Ash ou Eucalipto) ou marbre **BROSSÉ MATT** (Arabescato Orobico Gold, Tropikal Storm ou Domus White).

	I E D F	dimensioni dimension abmessungen dimension	spessore thickness stärke épaisseur	volume volume volumen volume	carico ammesso admitted load tragfähigkeit charge admise	peso weight gewicht poids	prezzo price preis prix
		cm	mm	m3	kg	kg	euro

After9

design Massimo Castagna 2020

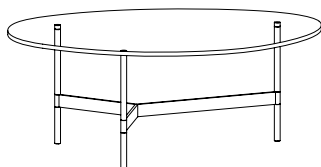

75 x 60 x h 20	10	0,077	30	20	□	1.380
					■	1.390
					■	1.400
75 x 60 x h 30	10	0,077	30	20	□	1.400
					■	1.410
					■	1.420
75 x 60 x h 40	10	0,077	30	20	□	1.420
					■	1.430
					■	1.440

- top vetro extrachiaro / extra clear glass top / Top aus extrahellem Glas / top verre extra clair
- top vetro fumè / smoked glass top / Top aus Rauchglas / top verre fumé
- top vetro bronzo / bronze glass top / Top aus Bronze Glas / top verre bronze

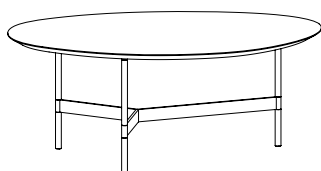

75 x 60 x h 21	16	0,077	30	14	●	1.650
					●●	1.640
75 x 60 x h 31	16	0,077	30	14	●	1.670
					●●	1.660
75 x 60 x h 41	16	0,077	30	14	●	1.690
					●●	1.680

- top legno Siberian Ash / Siberian Ash wood top/ Holztop Siberian Ash / top bois Siberian Ash
- top legno Eucalipto / Eucalipto wood top/ Holztop Eucalipto / top bois Eucalipto

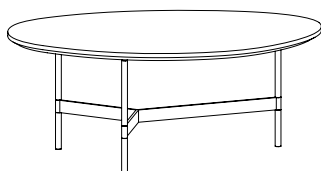

75 x 60 x h 21	20	0,077	30	30	▲	2.080
					▲▲	2.740
					▲▲▲	2.850
75 x 60 x h 31	20	0,077	30	30	▲	2.100
					▲▲	2.760
					▲▲▲	2.870
75 x 60 x h 41	20	0,077	30	30	▲	2.120
					▲▲	2.780
					▲▲▲	2.890

- ▲ top marmo Arabescato Orobico Gold / marble top Arabescato Orobico Gold
Marmortop Arabescato Orobico Gold / top marbre Arabescato Orobico Gold
- ▲▲ top marmo Tropikal Storm / marble top Tropikal Storm
Marmortop Tropikal Storm / top marbre Tropikal Storm
- ▲▲▲ top marmo Domus White / marble top Domus White
Marmortop Domus White / top marbre Domus White

**Specificare sempre la finitura del basamento in metallo / always specify finish of metal base
Immer Ausführung des Metallgestell angeben / indiquer toujours finition de la base en métal**

- Tavolo basso e fianco divano con struttura in metallo. Supporto superiore, disponibile solo in acciaio inox lucidato, telaio e supporto inferiore, disponibili nelle finiture: cromato, oro, rame, canna di fucile, lucide o spazzolate. Top in vetro (extrachiaro, fumè o bronzo), legno (Siberian Ash o Eucalipto) o marmo **SPAZZOLATO OPACO** (Arabescato Orobico Gold, Tropikal Storm o Domus White).
- Low table and side table with metal structure. Upper support available only in polished stainless steel, frame and lower support available in following finishes: chrome, gold, copper, gunmetal, polished or brushed. Top in glass (extra clear, smoked or bronze), wood (Siberian Ash or Eucalipto) or marble **BRUSHED MATT** (Arabescato Orobico Gold, Tropikal Storm or Domus White).
- Couchtisch und Beistelltisch mit Metallstruktur. Oberes Gestell nur in poliertem Edelstahl, unteres Gestell in folgenden Ausführungen: verchromt, gold, Kupfer, gunmetal, glänzend oder gebürstet. Top aus Glas (extrahell, Rauchglas oder bronze), Holz (Siberian Ash oder Eucalipto) oder **MATT GEBÜRSTETEM** Marmor (Arabescato Orobico Gold, Tropikal Storm oder Domus White).
- Table bas et table de chevet avec structure en métal. Support supérieur disponible seulement en acier inox. Armature et support inférieur disponible en finition : chrome, or, cuivre, gunmetal, brillant ou brossé. Top en verre (extra clair, fumé ou bronze), bois (Siberian Ash ou Eucalipto) ou marbre **BROSSÉ MATT** (Arabescato Orobico Gold, Tropikal Storm ou Domus White).

	I E D F	dimensioni dimension abmessungen dimension	spessore thickness stärke épaisseur	volume volume volumen volume	carico ammesso admitted load tragfähigkeit charge admise	peso weight gewicht poids		prezzo price preis prix
		cm	mm	m3	kg	kg		euro

After9

design Massimo Castagna 2020

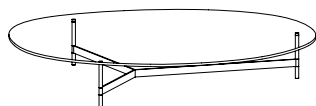

130 x 130 x h 20	10	0,286	40	48	□	1.870
					■	1.890
					■	1.910

130 x 130 x h 30	10	0,286	40	48	□	1.900
					■	1.920
					■	1.940

130 x 130 x h 40	10	0,286	40	48	□	1.930
					■	1.950
					■	1.970

- top vetro extrachiaro / extra clear glass top / Top aus extrahellem Glas / top verre extra clair
- top vetro fumè / smoked glass top / Top aus Rauchglas / top verre fumé
- top vetro bronzo / bronze glass top / Top aus Bronze Glas / top verre bronze

130 x 130 x h 21	16	0,286	40	31	●	2.560
					●●	2.540

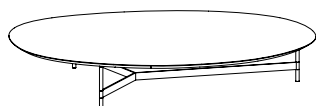

130 x 130 x h 31	16	0,286	40	31	●	2.590
					●●	2.570

130 x 130 x h 41	16	0,286	40	31	●	2.620
					●●	2.600

- top legno Siberian Ash / Siberian Ash wood top/ Holztop Siberian Ash / top bois Siberian Ash
- top legno Eucalipto / Eucalipto wood top/ Holztop Eucalipto / top bois Eucalipto

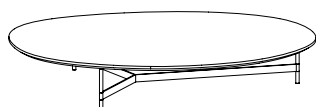

130 x 130 x h 21	20	0,286	40	65	▲	3.700
					▲▲	4.920
					▲▲▲	5.310

130 x 130 x h 31	20	0,286	40	65	▲	3.730
					▲▲	4.950
					▲▲▲	5.340

130 x 130 x h 41	20	0,286	40	65	▲	3.760
					▲▲	4.980
					▲▲▲	5.370

- ▲ top marmo Arabescato Orobico Gold / marble top Arabescato Orobico Gold
Marmortop Arabescato Orobico Gold / top marbre Arabescato Orobico Gold
- ▲▲ top marmo Tropikal Storm / marble top Tropikal Storm
Marmortop Tropikal Storm / top marbre Tropikal Storm
- ▲▲▲ top marmo Domus White / marble top Domus White
Marmortop Domus White / top marbre Domus White

**Specificare sempre la finitura del basamento in metallo / always specify finish of metal base
Immer Ausführung des Metallgestell angeben / indiquer toujours finition de la base en métal**

- Tavolo basso e fianco divano con struttura in metallo. Supporto superiore, disponibile solo in acciaio inox lucidato, telaio e supporto inferiore, disponibili nelle finiture: cromato, oro, rame, canna di fucile, lucide o spazzolate. Top in vetro (extrachiaro, fumè o bronzo), legno (Siberian Ash o Eucalipto) o marmo **SPAZZOLATO OPACO** (Arabescato Orobico Gold, Tropikal Storm o Domus White).
- Low table and side table with metal structure. Upper support available only in polished stainless steel, frame and lower support available in following finishes: chrome, gold, copper, gunmetal, polished or brushed. Top in glass (extra clear, smoked or bronze), wood (Siberian Ash or Eucalipto) or marble **BRUSHED MATT** (Arabescato Orobico Gold, Tropikal Storm or Domus White).
- Couchtisch und Beistelltisch mit Metallstruktur. Oberes Gestell nur in poliertem Edelstahl, unteres Gestell in folgenden Ausführungen: verchromt, gold, Kupfer, gunmetal, glänzend oder gebürstet. Top aus Glas (extrahell, Rauchglas oder bronze), Holz (Siberian Ash oder Eucalipto) oder **MATT GEBÜRSTETEM** Marmor (Arabescato Orobico Gold, Tropikal Storm oder Domus White).
- Table bas et table de chevet avec structure en métal. Support supérieur disponible seulement en acier inox. Armature et support inférieur disponible en finition : chrome, or, cuivre, gunmetal, brillant ou brossé. Top en verre (extra clair, fumé ou bronze), bois (Siberian Ash ou Eucalipto) ou marbre **BROSSÉ MATT** (Arabescato Orobico Gold, Tropikal Storm ou Domus White).

	I E D F	dimensioni dimension abmessungen dimension	spessore thickness stärke épaisseur	volume volume volumen volume	carico ammesso admitted load tragfähigkeit charge admise	peso weight gewicht poids		prezzo price preis prix
		cm	mm	m3	kg	kg		euro

After9

design Massimo Castagna 2020

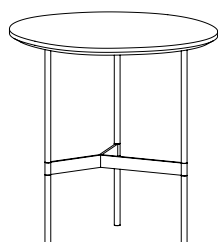

50 x 50 x h 31	20	0,059	20	18	▲	1.810
					▲▲	1.910
50 x 50 x h 41	20	0,059	20	18	▲	1.830
					▲▲	1.930
50 x 50 x h 51	20	0,059	20	18	▲	1.850
					▲▲	1.950

- ▲ top marmo Nero Marquinia o Bianco Carrara / marble top Nero Marquinia or Bianco Carrara
Marmortop Nero Marquinia oder Bianco Carrara / top marbre Nero Marquinia ou Bianco Carrara
- ▲▲ top marmo Sahara Noir / marble top Sahara Noir
Marmortop Sahara Noir / top Sahara Noir

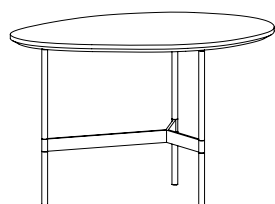

65 x 45 x h 31	20	0,064	20	21	▲	1.890
					▲▲	1.990
65 x 45 x h 41	20	0,064	20	21	▲	1.910
					▲▲	2.010
65 x 45 x h 51	20	0,064	20	21	▲	1.930
					▲▲	2.030

- ▲ top marmo Nero Marquinia o Bianco Carrara / marble top Nero Marquinia or Bianco Carrara
Marmortop Nero Marquinia oder Bianco Carrara / top marbre Nero Marquinia ou Bianco Carrara
- ▲▲ top marmo Sahara Noir / marble top Sahara Noir
Marmortop Sahara Noir / top Sahara Noir

**Specificare sempre la finitura del basamento in metallo / always specify finish of metal base
Immer Ausführung des Metallgestell angeben / indiquer toujours finition de la base en métal**

- Tavolo basso e fianco divano con struttura in metallo. Supporto superiore, disponibile solo in acciaio inox lucidato, telaio e supporto inferiore, disponibili nelle finiture: cromato, oro, rame, canna di fucile, lucide o spazzolate. Top in marmo **LUCIDO** (Nero Marquinia, Bianco Carrara o Sahara Noir).
- Low table and side table with metal structure. Upper support available only in polished stainless steel, frame and lower support available in following finishes: chrome, gold, copper, gunmetal, polished or brushed. Top in **POLISHED** marble (Nero Marquinia, Bianco Carrara or Sahara Noir).
- Couchtisch und Beistelltisch mit Metallstruktur. Oberes Gestell nur in poliertem Edelstahl, unteres Gestell in folgenden Ausführungen: verchromt, gold, Kupfer, gunmetal, glänzend oder gebürstet. Top aus **GLÄNZENDEM** Marmor (Nero Marquinia, Bianco Carrara oder Sahara Noir).
- Table bas et table de chevet avec structure en métal. Support supérieur disponible seulement en acier inox. Armature et support inférieur disponible en finition : chrome, or, cuivre, gunmetal, brillant ou brossé. Top en marbre **BRILLANT** (Nero Marquinia, Bianco Carrara ou Sahara Noir).

	I E D F	dimensioni dimension abmessungen dimension	spessore thickness stärke épaisseur	volume volume volumen volume	carico ammesso admitted load tragfähigkeit charge admise	peso weight gewicht poids	prezzo price preis prix
		cm	mm	m3	kg	kg	euro

After9

design Massimo Castagna 2020

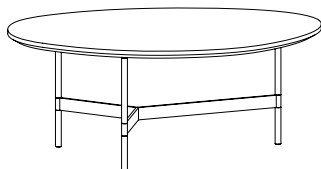

75 x 60 x h 21	20	0,077	30	30	▲	2.160
					▲▲	2.310
75 x 60 x h 31	20	0,077	30	30	▲	2.180
					▲▲	2.330
75 x 60 x h 41	20	0,077	30	30	▲	2.200
					▲▲	2.350

▲ top marmo Nero Marquinia o Bianco Carrara / marble top Nero Marquinia or Bianco Carrara
Marmortop Nero Marquinia oder Bianco Carrara / top marbre Nero Marquinia ou Bianco Carrara

▲▲ top marmo Sahara Noir / marble top Sahara Noir
Marmortop Sahara Noir / top Sahara Noir

130 x 130 x h 21	20	0,286	40	65	▲	3.800
					▲▲	4.450
130 x 130 x h 31	20	0,286	40	65	▲	3.830
					▲▲	4.480
130 x 130 x h 41	20	0,286	40	65	▲	3.860
					▲▲	4.510

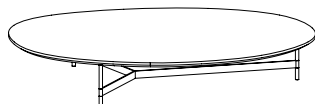

▲ top marmo Nero Marquinia o Bianco Carrara / marble top Nero Marquinia or Bianco Carrara
Marmortop Nero Marquinia oder Bianco Carrara / top marbre Nero Marquinia ou Bianco Carrara

▲▲ top marmo Sahara Noir / marble top Sahara Noir
Marmortop Sahara Noir / top Sahara Noir

Specificare sempre la finitura del basamento in metallo / always specify finish of metal base
Immer Ausführung des Metallgestell angeben / indiquer toujours finition de la base en métal

- Tavolo basso e fianco divano con struttura in metallo. Supporto superiore, disponibile solo in acciaio inox lucidato, telaio e supporto inferiore, disponibili nelle finiture: cromato, oro, rame, canna di fucile, lucide o spazzolate. Top in marmo **LUCIDO** (Nero Marquinia, Bianco Carrara o Sahara Noir).
- Low table and side table with metal structure. Upper support available only in polished stainless steel, frame and lower support available in following finishes: chrome, gold, copper, gunmetal, polished or brushed. Top in **POLISHED** marble (Nero Marquinia, Bianco Carrara or Sahara Noir).
- Couchtisch und Beistelltisch mit Metallstruktur. Oberes Gestell nur in poliertem Edelstahl, unteres Gestell in folgenden Ausführungen: verchromt, gold, Kupfer, gunmetal, glänzend oder gebürstet. Top aus **GLÄNZENDEM** Marmor (Nero Marquinia, Bianco Carrara oder Sahara Noir).
- Table bas et table de chevet avec structure en métal. Support supérieur disponible seulement en acier inox. Armature et support inférieur disponible en finition : chrome, or, cuivre, gunmetal, brillant ou brossé. Top en marbre **BRILLANT** (Nero Marquinia, Bianco Carrara ou Sahara Noir).

	I E D F	dimensioni dimension abmessungen dimension	spessore thickness stärke épaisseur	volume volume volumen volume	carico ammesso admitted load tragfähigkeit charge admise	peso weight gewicht poids	prezzo price preis prix
		cm	mm	m3	kg	kg	euro

After9_fused glass

design Massimo Castagna 2023

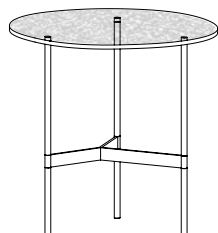

50 x 50 x h 30	10	0,059	20	13	■ 1.840	■ 1.850
50 x 50 x h 40	10	0,059	20	13	■ 1.860	■ 1.870
50 x 50 x h 50	10	0,059	20	13	■ 1.880	■ 1.890

- top vetro fuso fumè / smoked fused glass top / Top aus geschmolzenem Rauchglas top verre en fusion fumé
- top vetro fuso bronzo / fused bronze glass top / Top aus geschmolzenem Bronze Glas top verre en fusion bronze

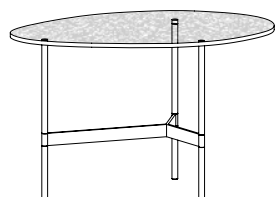

65 x 45 x h 30	10	0,064	20	15	■ 1.930	■ 1.940
65 x 45 x h 40	10	0,064	20	15	■ 1.950	■ 1.960
65 x 45 x h 50	10	0,064	20	15	■ 1.970	■ 1.980

- top vetro fuso fumè / smoked fused glass top / Top aus geschmolzenem Rauchglas top verre en fusion fumé
- top vetro fuso bronzo / fused bronze glass top / Top aus geschmolzenem Bronze Glas top verre en fusion bronze

**Specificare sempre la finitura del basamento in metallo / always specify finish of metal base
Immer Ausführung des Metallgestell angeben / indiquer toujours finition de la base en métal**

- Tavolo basso e fianco divano con struttura in metallo. Supporto superiore, disponibile solo in acciaio inox lucidato, telaio e supporto inferiore, disponibili nelle finiture: cromato, oro, rame, canna di fucile, lucide o spazzolate. Top in vetro fuso fumé e bronzo.
- Low table and side table with metal structure. Upper support available only in polished stainless steel, frame and lower support available in following finishes: chrome, gold, copper, gunmetal, polished or brushed. Top in fused smoked and bronze glass.
- Couchtisch und Beistelltisch mit Metallstruktur. Oberes Gestell nur in poliertem Edelstahl, unteres Gestell in folgenden Ausführungen: verchromt, gold, Kupfer, gunmetal, glänzend oder gebürstet. Top aus geschmolzenem Rauchglas und Bronze Glas.
- Table bas et table de chevet avec structure en métal. Support supérieur disponible seulement en acier inox. Armature et support inférieur disponible en finition : chrome, or, cuivre, gunmetal, brillant ou brossé. Top en verre en fusion fumé ou bronze.

	I E D F	dimensioni dimension abmessungen dimension	spessore thickness stärke épaisseur	volume volume volumen volume	carico ammesso admitted load tragfähigkeit charge admise	peso weight gewicht poids	prezzo price preis prix
		cm	mm	m3	kg	kg	euro

After9_fused glass

design Massimo Castagna 2023

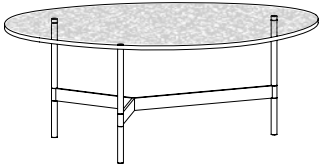

75 x 60 x h 20	10	0,077	30	20	■ 1.900 ■ 1.910
75 x 60 x h 30	10	0,077	30	20	■ 1.920 ■ 1.930
75 x 60 x h 40	10	0,077	30	20	■ 1.940 ■ 1.950

- top vetro fuso fumè / smoked fused glass top / Top aus geschmolzenem Rauchglas top verre en fusion fumé
- top vetro fuso bronzo / fused bronze glass top / Top aus geschmolzenem Bronze Glas top verre en fusion bronze

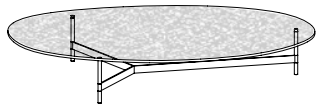

130 x 130 x h 20	10	0,286	40	48	■ 2.750 ■ 2.770
130 x 130 x h 30	10	0,286	40	48	■ 2.780 ■ 2.800
130 x 130 x h 40	10	0,286	40	48	■ 2.810 ■ 2.820

- top vetro fuso fumè / smoked fused glass top / Top aus geschmolzenem Rauchglas top verre en fusion fumé
- top vetro fuso bronzo / fused bronze glass top / Top aus geschmolzenem Bronze Glas top verre en fusion bronze

**Specificare sempre la finitura del basamento in metallo / always specify finish of metal base
Immer Ausführung des Metallgestell angeben / indiquer toujours finition de la base en métal**

- Tavolo basso e fianco divano con struttura in metallo. Supporto superiore, disponibile solo in acciaio inox lucidato, telaio e supporto inferiore, disponibili nelle finiture: cromato, oro, rame, canna di fucile, lucide o spazzolate. Top in vetro fuso fumè e bronzo.
- Low table and side table with metal structure. Upper support available only in polished stainless steel, frame and lower support available in following finishes: chrome, gold, copper, gunmetal, polished or brushed. Top in fused smoked and bronze glass.
- Couchtisch und Beistelltisch mit Metallstruktur. Oberes Gestell nur in poliertem Edelstahl, unteres Gestell in folgenden Ausführungen: verchromt, gold, Kupfer, gunmetal, glänzend oder gebürstet. Top aus geschmolzenem Rauchglas und Bronze Glas.
- Table bas et table de chevet avec structure en métal. Support supérieur disponible seulement en acier inox. Armature et support inférieur disponible en finition : chrome, or, cuivre, gunmetal, brillant ou brossé. Top en verre en fusion fumé ou bronze.

	I E D F	dimensioni dimension abmessungen dimension	spessore thickness stärke épaisseur	volume volume volumen volume	carico ammesso admitted load tragfähigkeit charge admise	peso weight gewicht poids	prezzo price preis prix
		cm	mm	m3	kg	kg	euro

Albero

Ø 50 x h 167

12 / 15 / 20

0,502

3-3-5-5-15-15 *

67

2.350

design Isao Hosoe 1988

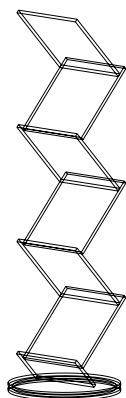

* dall'alto/from upper side/von oben nach unten/du haut

- Porta riviste o porta libri su base rotante.
- Magazine/book holder with revolving base.
- Zeitschriften-Ständer mit drehbarer Basis.
- Porte revues sur base pivotante.

Alfabetà

40 x 24 x h 40

10

0,13

10

25

900

□ 980

■ 1.080

design Nanni_Bortolani 1997

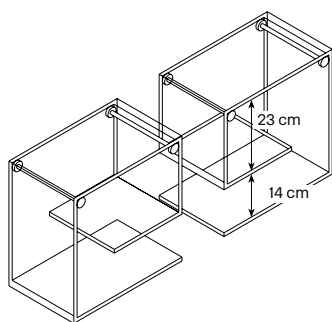

prezzo per coppia / price for couple / preis für paar / prix par pair

- versione extrachiaro / extra clear version / version extrahell / version extra clair
- Vetro fumé / smoked glass / Rauchglas / verre fumé

- Mensole con due supporti a muro, in vetro float 10 mm, utilizzabili in diverse posizioni.
- Wall-shelf with two supports, float glass 10 mm, can be fixed in different positions.
- Wandkonsole mit zwei Halterungen, Float Glas 10 mm, in verschiedenen Positionen benutzbar.
- Etagère murale avec deux supports, verre float 10 mm, utilisable en différentes positions.

	I E D F	dimensioni dimension abmessungen dimension	spessore thickness stärke épaisseur	volume volume volumen volume	carico ammesso admitted load tragfähigkeit charge admise	peso weight gewicht poids	prezzo price preis prix
		cm	mm	m3	kg	kg	euro

Amon 1

design Roberto Garbugli 2008

58 x 58 x h 160

0,78

82

- 2.060
- 2.220
- 1.920
- 2.170
- 2.180

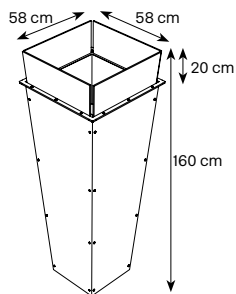

Amon 2

design Roberto Garbugli 2008

58 x 58 x h 120

0,58

62

- 1.780
- 1.920
- 1.660
- 1.880
- 1.890

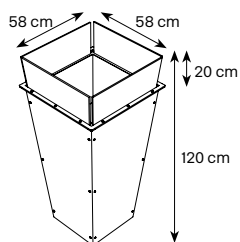

Amon 3

design Roberto Garbugli 2008

58 x 58 x h 80

0,38

54

- 1.530
- 1.650
- 1.420
- 1.610
- 1.620

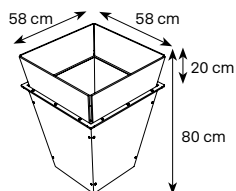

- Vetro laccato nero / Black lacquered glass / Schwarz lackiertes Glas / Verre lacqué noir
- Vetro laccato bianco / White lacquered glass / Weiss lackiertes Glas / Verre lacqué blanc

- Specchio / Mirror / Spiegel / Miroir
- Specchio fumè / Smoked mirror / Rauchglasspiegel / miroir fumé
- Specchio bronzo / Bronze mirror / Bronze Spiegel / Miroir bronze

Specificare sempre il tipo di vite: acciaio inox o ottone.
Always specify the kind of screw: stainless steel or brass.
Immer Schraubensorte angeben: Edelstahl oder Messing.
Spécifier toujours la sorte de vis: acier inoxydable ou cuivre.

**Optional: Impianto luce Led / Lighting Led kit /
 Beleuchtungskit mit Led / Kit d'illumination Led**

490

- Disponibile in 3 misure. Sistema di fissaggio con viti a vista in ottone o acciaio inox a scelta. Struttura interna in lamiera zincata.
- Available in 3 different sizes Fixing system with screws in view in brass or stainless steel. Internal structure in galvanised sheet.
- In 3 Maßen verfügbar. Befestigungssystem mit Schrauben in Sicht aus Edelstahl oder Messing. Interne Struktur aus verzinktem Blech.
- Disponible en 3 mesures. Système de fixation avec vis a vue en acier inoxydable ou cuivre. Structure intérieure en tôle galvanisée.

	I E D F	dimensioni dimension abmessungen dimension	spessore thickness stärke épaisseur	volume volume volumen volume	carico ammesso admitted load tragfähigkeit charge admise	peso weight gewicht poids	prezzo price preis prix
		cm	mm	m3	kg	kg	euro

Aw_chair

49 x 58 x h 81

0,36

6

design Massimo Castagna 2023

FINITURA STRUTTURA / STRUCTURE FINISH STRUKTURAUSFÜHRUNG / FINITION STRUCTURE	SEDUTA-SCHIENALE / SEAT-BACKREST / SITZ-SITZLEHNE / ASSISE-DOSSIER			
	TESSUTO C / FABRIC C STOFF C / TISSU C	TESSUTO P / FABRIC P STOFF P / TISSU P	TESSUTO F / FABRIC F STOFF F / TISSU F	TESSUTO B / FABRIC B STOFF B / TISSU B
laccato nero poro aperto / open grain black lacquered offenporig schwarz lackiert / laque noir pores ouverts	570	610	640	670
rovere naturale / natural oak natur eiche / rouvre naturel	595	635	665	695
siberian ash / eucalipto	590	630	660	690

ORDINE MINIMO N. 4 SEDIE / MINIMUM ORDER N. 4 CHAIRS MINDESTBESTELLUNG N.4 STÜHLE / COMMANDE MINIMUM N. 4 CHAISES

Finiture tessuti vedi catalogo 2023 pag. 350 - 351 / Fabrice finishes see catalogue 2023 pages 350 - 351
Stoffausführungen siehe Katalog 2023 Seiten 350 - 351 / Finitions tissus voir catalogues 2023 pages 350 - 351

Per informazioni su eventuale tessuto cliente rivolgersi all'ufficio vendite per prezzo e metraggi.
For information on possible custom fabrics contact sales office for price and length
Für Informationen bezüglich personalisierter Stoffe bitte wenden Sie sich an unser Verkaufsbüro für Preise und Maße
Pour information sur tissus personnalisés contactez notre bureau de vente pour prix et métrage.

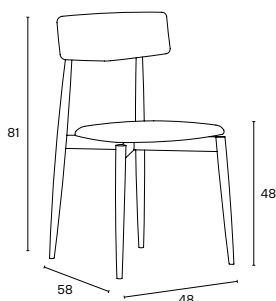

- Sedia in legno massello di frassino. Seduta sagomata e imbottita, rivestita in tessuto. Schienale in legno curvato a vista sul retro, imbottito e rivestito in tessuto frontalmente con cucitura a cordone sul bordo. Giunto di unione fra schienale e struttura in metallo lucidato. Sedia non sfoderabile.
- Chair in solid ash wood. Shaped and upholstered seat, covered in fabric. Curved wooden backrest, frontally upholstered and covered in fabric with cord stitching on the edge. Junction between backrest and structure in polished metal. Covering not removable. Fabric covering not removable.
- Holzstuhl aus massivem Eschenholz. Profiliertes und gepolstertes Sitz mit Stoff überzogen. Rücklehne aus gebogenem Holz, vorne gepolstert und Stoffbekleidung mit Kordelnaht am Rand. Verbindung zwischen Rücklehne und Struktur aus poliertem Metall. Nicht abziehbarer Stuhl.
- Chaise en bois massif de frêne. Assise profilé et rembourré, revêtu en tissu. Dos en bois incurvé, rembourré et revêtu en tissu frontalement avec couture à cordon sur le bord. Joint entre dos et structure en métal poli. Chaise non déhoussable.

Aperture

design Karim Rashid 2017

A 108 x h 108 x 16

4

0,46

46

● 1.540

●● 1.660

B 200 x h 200 x 20

4

1,59

131

● 3.370

●● 3.680

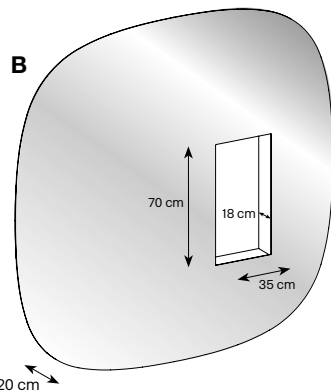
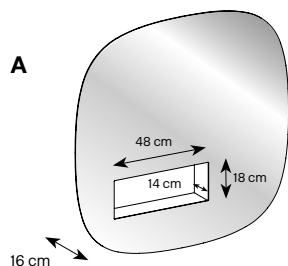

- Specchio / mirror / Spiegel / miroir
- Specchio fumé / smoked mirror / Rauchglasspiegel / miroir fumé

SPECIFICARE SEMPRE IL COLORE DEL VANO INTERNO ALWAYS SPECIFY COLOUR OF INTERNAL COMPARTMENT IMMER FARBE DES ABLAGEFACHES ANGEBEN SPECIFIER TOUJOURS COULEUR DE LA BOÎTE A GANTS INTERIEURE

- Specchio da parete, disponibile anche in finitura fumé. Vano interno laccato bianco, nero o rosa lucido. **Illuminazione led con sensore di movimento.**
- Wall mirror, available also in smoked mirror. Internal compartment lacquered shiny white, black or pink. **Led lighting with motion detector.**
- Wandspiegel, auch in Rauchglasspiegel erhältlich. Internes Ablagefach glänzend weiß, schwarz oder rosa lackiert. **Led Beleuchtung mit Bewegungsmelder.**
- Miroir à mur, disponible aussi en miroir fumé. Boîte à gants intérieur laqué blanc, noir ou rose brillant. **Illumination à led avec détecteur de mouvement.**

	I E D F	dimensioni dimension abmessungen dimension	spessore thickness stärke épaisseur	volume volume volumen volume	carico ammesso admitted load tragfähigkeit charge admise	peso weight gewicht poids	prezzo price preis prix
		cm	mm	m3	kg	kg	euro

Atomic

92 x h 160 x 3

4/5

0,161

45

1.970

design G.T. Garattoni 2016

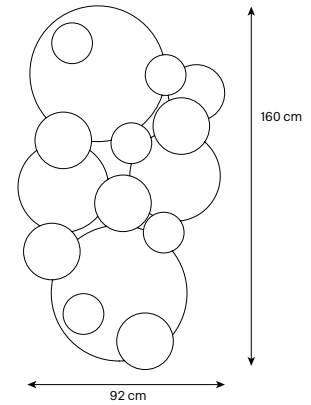
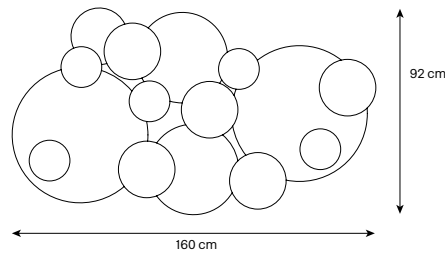
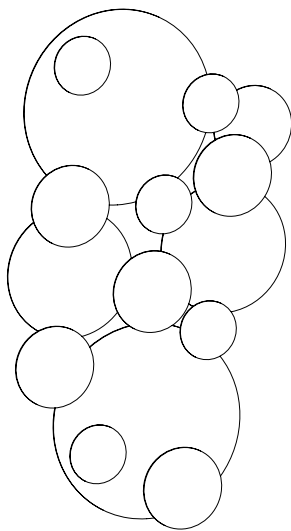

- Specchiera da parete composta da elementi circolari a specchio in diverse dimensioni. Finiture: specchio, fumè, bronzo, oro, rosa e grigio. Posizionabile sia in verticale che in orizzontale.
- Wall mirror made of round mirrors in different dimensions. Finishes: mirror, smoked, bronze, gold, pink and grey. Can be hung either vertically or horizontally.
- Wandspiegel aus runden Spiegeln in verschiedenen Maßen. Ausfertigung: Spiegel, Rauchglas, Bronze, gold, rosa and grau. Kann senkrecht oder waagrecht aufgehängt werden.
- Miroir au mur composé de éléments circulaires en miroirs en différents dimensions. Finitions: miroir, fumé, bronze, or, rose et gris. Peut être positionner en vertical ou horizontal.

Atomic

102 x h 205 x 3

4/5

0,216

55

2.780

design G.T. Garattoni 2016

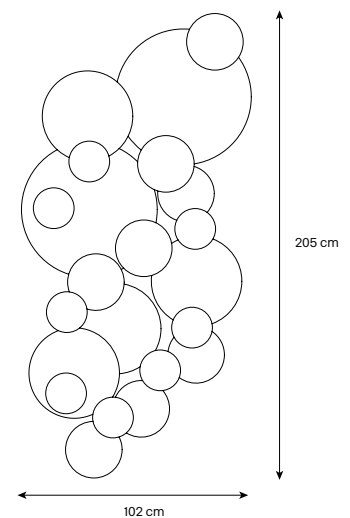
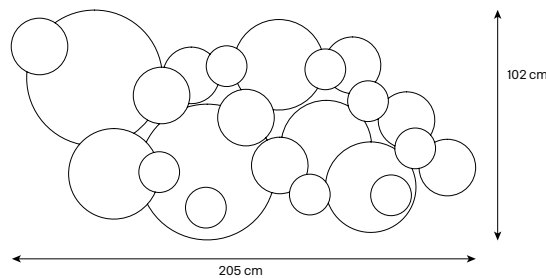
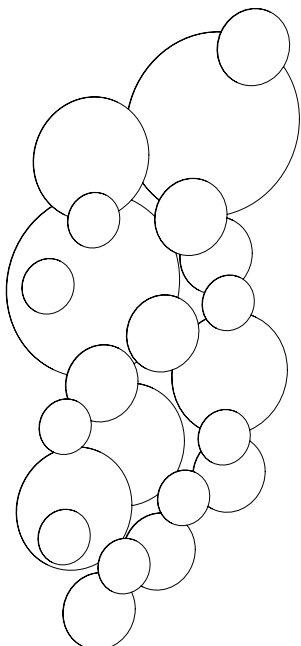

- Specchiera da parete composta da elementi circolari a specchio in diverse dimensioni. Finiture: specchio, fumè, bronzo, oro, rosa e grigio. Posizionabile sia in verticale che in orizzontale.
- Wall mirror made of round mirrors in different dimensions. Finishes: mirror, smoked, bronze, gold, pink and grey. Can be hung either vertically or horizontally.
- Wandspiegel aus runden Spiegeln in verschiedenen Maßen. Ausfertigung: Spiegel, Rauchglas, Bronze, gold, rosa and grau. Kann senkrecht oder waagrecht aufgehängt werden.
- Miroir au mur composé de éléments circulaires en miroirs en différents dimensions. Finitions: miroir, fumé, bronze, or, rose et gris. Peut être positionner en vertical ou horizontal.

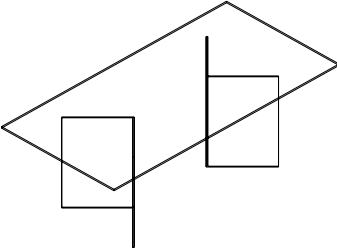
	I E D F	dimensioni dimension abmessungen dimension	spessore thickness stärke épaisseur	volume volume volumen volume	carico ammesso admitted load tragfähigkeit charge admise	peso weight gewicht poids	prezzo price preis prix
		cm	mm	m3	kg	kg	euro
Bacco design M. U. 		180x90 x h 73	12	0,356	150	96	1.460 <input type="checkbox"/> 1.670 <input checked="" type="checkbox"/> 1.920
		200x100 x h 73	12	0,369	150	110	1.530 <input type="checkbox"/> 1.820 <input checked="" type="checkbox"/> 2.090
		225x90 x h 73	12	0,380	150	110	1.550 <input type="checkbox"/> 1.850 <input checked="" type="checkbox"/> 2.130
		240x100 x h 73	12	0,390	150	116	1.630 <input type="checkbox"/> 1.950 <input checked="" type="checkbox"/> 2.240
		245x120 x h 73	12	0,44	150	140	1.860 <input type="checkbox"/> 2.300 <input checked="" type="checkbox"/> 2.650
		260x100 x h 73	12	0,45	150	150	2.360 <input type="checkbox"/> 2.830 <input checked="" type="checkbox"/> 3.250
		280x100 x h 73	12 / 15	0,47	150	157	2.540 <input type="checkbox"/> 3.080 <input checked="" type="checkbox"/> -
		300x100 x h 73	12 / 15	0,49	150	165	2.680 <input type="checkbox"/> 3.250 <input checked="" type="checkbox"/> -

- top e basamento vetro extrachiaro / extra clear glass top and base
 Top und Gestell aus extrahellem Glas / top et piètement en verre extra clair
 top e basamento vetro fumè / smoked glass top and base
 Top und Gestell aus Rauchglas / top et piètement en verre fumé

- Tavolo o scrivania in vetro trasparente, extrachiaro o fumè.
 - Dining table or desk in transparent, extra clear or smoked glass
 - Esstisch oder Schreibtisch aus Klarglas, extrahelles Glas oder Rauchglas
 - Table ou bureau en verre transparent, extra clair ou fumé.

	I E D F	dimensioni dimension abmessungen dimension	spessore thickness stärke épaisseur	volume volume volumen volume	carico ammesso admitted load tragfähigkeit charge admise	peso weight gewicht poids	prezzo price preis prix
		cm	mm	m3	kg	kg	euro

Bands

angeletti ruzza design 2019

A	100 x 4 x h 100	8	0,16			47	● 1.510 ●● 1.630 ●●● 1.640
----------	-----------------	---	------	--	--	----	----------------------------------

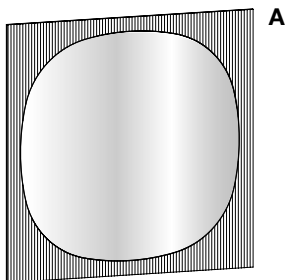

B	90 x 4 x h 180	8	0,25			62	● 2.180 ●● 2.360 ●●● 2.370
----------	----------------	---	------	--	--	----	----------------------------------

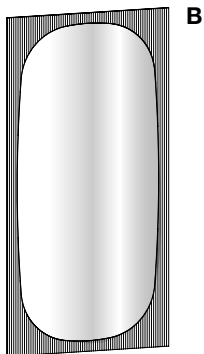

C	110 x 4 x h 200	8	0,33			98	● 2.660 ●● 2.880 ●●● 2.890
----------	-----------------	---	------	--	--	----	----------------------------------

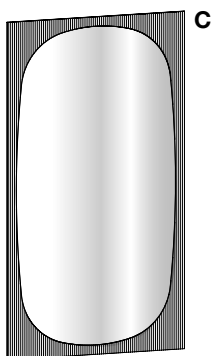

- Specchio / Mirror / Spiegel / Miroir
- Specchio fumè / Smoked mirror / Rauchglasspiegel / miroir fumé
- Specchio bronzo / Bronze mirror / Bronze Spiegel / Miroir bronze

- Specchio da parete con cornice realizzata dall'unione di uno specchio e di un vetro cannettato. Disponibile in specchio, specchio fumè e bronzo. La cornice è sempre della stessa finitura dello specchio centrale.
- Wall mirror with frame created by joining a mirror with a reeds-like effect glass. Available in mirror, smoked mirror and bronze. The frame always has the same finish of the central mirror
- Wandspiegel mit Rahmen, der aus der Vereinigung von einem Spiegel und einem Schilffartigem Glas verwirklicht ist. Verfügbar in Spiegel, Rauchglasspiegel und Bronze. Der Rahmen hat immer die Ausführung des zentralen Spiegel.
- Miroir au mur avec corniche réalisé par l'union d'un miroir et d'une verre à effet cannaie. Disponible en miroir, miroir fumé ou bronze. La corniche a toujours la même finition du miroir.

	I E D F	dimensioni dimension abmessungen dimension	spessore thickness stärke épaisseur	volume volume volumen volume	carico ammesso admitted load tragfähigkeit charge admise	peso weight gewicht poids	prezzo price preis prix
		cm	mm	m3	kg	kg	euro

Barcode

design G. Maurizio Scutellà 2019

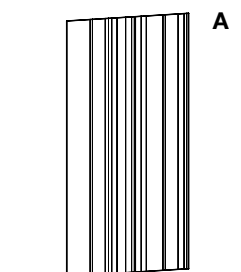

A

A	100 x 3 x h 200	8	0,25			67	2.180
----------	-----------------	---	------	--	--	----	-------

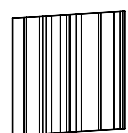

B

B	90 x 3 x h 90	8	0,11			35	1.140
----------	---------------	---	------	--	--	----	-------

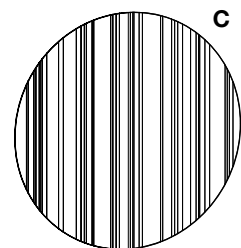

C

C	∅ 200 x 3	8	0,50			114	* 3.940
----------	-----------	---	------	--	--	-----	---------

- * lo specchio è realizzato da due elementi accostati (D+D)
- * mirror made by combining two elements (D+D)
- * Spiegel ergibt sich aus zwei Elementen nebeneinander (D+D)
- * miroir réalisé par deux éléments approchés (D+D)

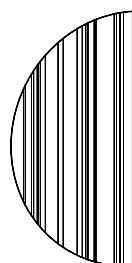

D

D	100 x 3 x h 200	8	0,25			57	* 1.970
----------	-----------------	---	------	--	--	----	---------

- * Semicerchio / semicircle / Halbkreis / demi-cercle

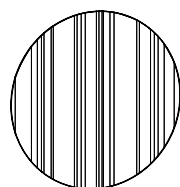

E

E	∅ 120 x 3	8	0,19			48	1.770
----------	-----------	---	------	--	--	----	-------

F	∅ 90 x 3	8	0,09			33	* 1.380
----------	----------	---	------	--	--	----	---------

- * lo specchio è realizzato da due elementi accostati (G+G)
- * mirror made by combining two elements (G+G)
- * Spiegel ergibt sich aus zwei Elementen nebeneinander (G+G)
- * miroir réalisé par deux éléments approchés (G+G)

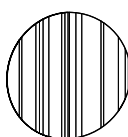

F

G	45 x 3 x h 90	8	0,05			24	* 690
----------	---------------	---	------	--	--	----	-------

- * Semicerchio / semicircle / Halbkreis / demi-cercle

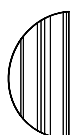

G

- Specchio da parete formato da un vetro dove si alternano fasce specchiate a fasce trasparenti. Le fasce trasparenti permettono di vedere la parete retrostante.
- Wall mirror made of a glass panel with alternating mirrored and transparent bands. The transparent bands allow to see the wall behind.
- Wandspiegel aus einem Glaspanel mit abwechselnden transparenten und verspiegelten Streifen. Die Rückwand ist durch die transparenten Streifen sichtbar.
- Miroir au mur réalisé avec une verre où il y a une alternance de bandes en miroir et transparent. Les bandes transparents permettent de voir le mur à l'arrière.

Barcode

design G. Maurizio Scutellà 2019

Composizioni / compositions / Kompositionen / compositions

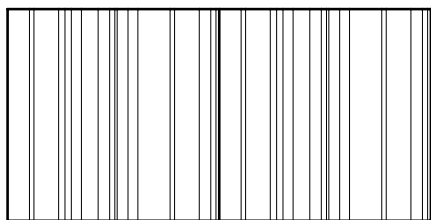

Comp. 1 - 180 x 3 x h 90 (B+B)
euro **2.280**

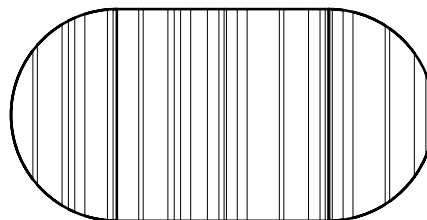

Comp. 2 - 180 x 3 x h 90 (G+B+G)
euro **2.520**

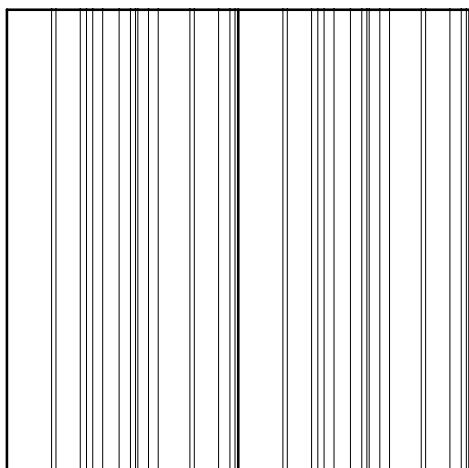

Comp. 3 - 200 x 3 x h 200 (A+A)
euro **4.360**

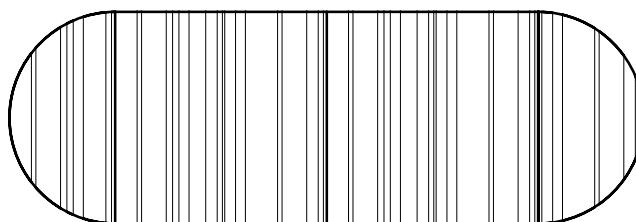

Comp. 4 - 270 x 3 x h 90 (G+B+B+G)
euro **3.660**

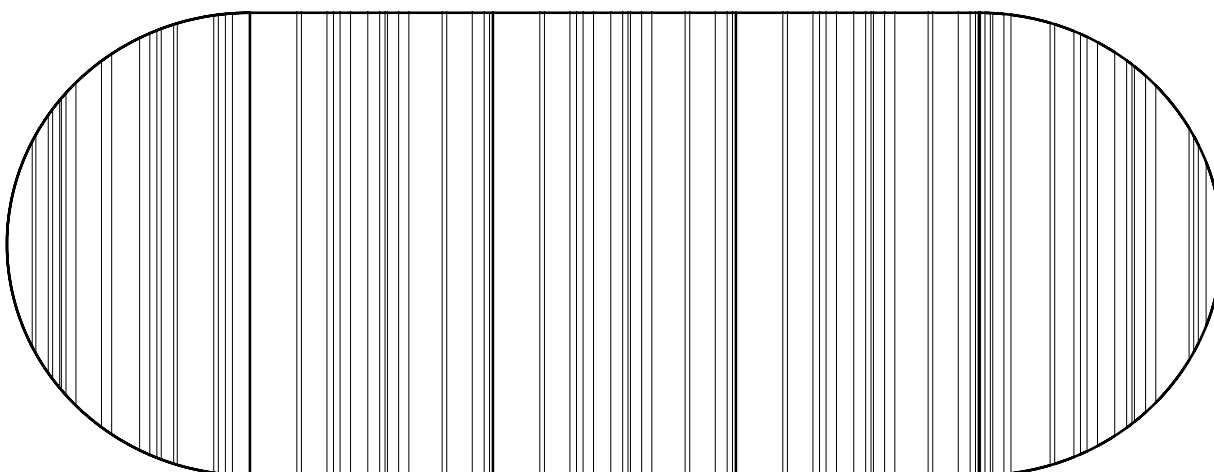

Comp. 5 - 500 x 3 x h 200 (D+A+A+A+D)
euro **10.480**

-
- Esempi di composizioni che si possono ottenere accostando tra di loro gli elementi di pagina 16.
 - Examples of compositions given by joining elements of page 16.
 - Kompositionsbeispiele der Elemente auf Seite 16
 - Exemples de compositions que on peut obtenir en rapprochant les éléments de page 16

	I E D F	dimensioni dimension abmessungen dimension	spessore thickness stärke épaisseur	volume volume volumen volume	carico ammesso admitted load tragfähigkeit charge admise	peso weight gewicht poids	prezzo price preis prix
		cm	mm	m3	kg	kg	euro

Bakkarat alto

design D'Urbino Lomazzi 2014

Ø 110 x h 75	12/30	0,28	120	82	2.850
Ø 120 x h 75	12/30	0,3	120	87	2.980
Ø 130 x h 75	12/30	0,33	120	92	3.130
Ø 140 x h 75	12/30	0,36	120	97	3.280

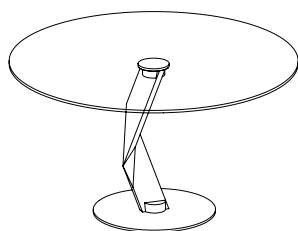

- Tavolo alto con piano in vetro temperato, gamba centrale in vetro spessore 30mm, base in metallo cromato. Disponibile solo in vetro extrachiaro.
- High table with extra clear tempered glass top, central leg in 30mm thick glass, chrome metal base. Available only in extra clear glass.
- Hoher Tisch mit extraheller Glasplatte aus Sicherheitsglas, zentraler Bein aus 30mm dickem Glas, Grundgestell aus verchromten Metall. Nur in extrahellem Glas erhältlich.
- Table haute avec plateau en verre extra clair trempé, pied central en épaisseur 30mm, base en métal chromé. Disponible seulement en verre extra clair.

Bakkarat

design D'Urbino - Lomazzi 2013

Ø 50 x h 45	10/20	0,22	20	18	960
Ø 60 x h 45	10/20	0,3	20	21	970
Ø 50 x h 65	10/20	0,29	20	20	980
Ø 60 x h 65	10/20	0,37	20	23	990

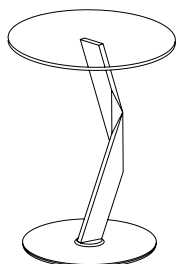

- Tavolino multiuso, gamba in vetro forte spessore, disponibile solo in vetro extrachiaro ed in due diverse altezze.
- Multipurpose table, leg in thick glass, available only in extra clear glass and in two different heights.
- Mehrzwecktisch, Bein aus starkem Glas, nur in extrahellem Glas und in zwei verschiedenen Höhen erhältlich.
- Table à usages multiples, pied en verre de fort épaisseur, disponible seulement en verre extra clair et en deux différents hauteurs.

	I E D F	dimensioni dimension abmessungen dimension	spessore thickness stärke épaisseur	volume volume volumen volume	carico ammesso admitted load tragfähigkeit charge admise	peso weight gewicht poids	prezzo price preis prix
		cm	mm	m3	kg	kg	euro

Broadway vetrina

Bartoli design 2005

94 x 46 x h 170	6 / 8	0,50	*15	128	● 3.940
					●● 3.980

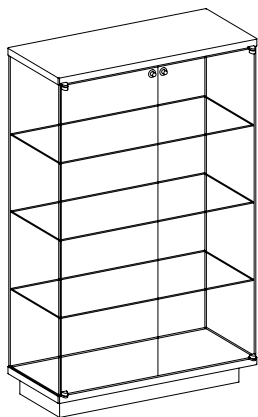

- con serratura / with lock / mit Schloss / avec serrure
- con pomolo / with knob / mit Griff / avec poimeau

- Ripiano in vetro aggiuntivo.
- Additional glass shelf.
- Zusätzlicher Boden.
- Étagère vitrée supplémentaire.

230

* ogni ripiano / on each shelf / auf jedem Bord / pour chaque étagère

49 x 46 x h 170	6 / 8	0,31	*12	83	● 2.860
					●● 2.880

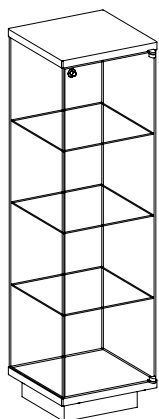

- con serratura / with lock / mit Schloss / avec serrure
- con pomolo / with knob / mit Griff / avec poimeau

- Ripiano in vetro aggiuntivo.
- Additional glass shelf.
- Zusätzlicher Boden.
- Étagère vitrée supplémentaire.

170

* ogni ripiano / on each shelf / auf jedem Bord / pour chaque étagère

- Disponibile in versione destra o sinistra
- Available in right or left
- Verfügbar rechts oder links
- Disponible en version droite ou gauche

dx / right / recht / droit



- Kit illuminazione standard led (1 lampadina + trasformatore)
- Standard Led Lighting kit (1 bulb + transformer)
- Standardbeleuchtungskit LED (1 birne + trafo)
- Kit d'illumination Led standard (1 ampoule + transformateur)

340



- Ogni lampadina supplementare con supporto
- Each additional bulb with support
- Jede zusätzliche Birne mit Halterungen
- Chaque lampe supplémentaire avec support

180

- Specificare sempre il colore (bianco o nero) di base in legno e top.
- Always specify colour (white or black) for wood base and top.
- Bitte immer die Farbe des Holz Grundgestells und Tops angeben (weiß oder schwarz).
- Indiquer toujours la couleur (blanc ou noir) de la base en bois et du plan supérieur.

- Vetrina in vetro trasparente temperato a tre ripiani. Base, top e zoccolo in legno laccato, nero o bianco. Presenza di ruote nascoste nella parte inferiore per agevolare lo spostamento.
- Display unit in transparent tempered glass with three shelves. Base, top and plinth in white or black lacquered wood. Hidden castors in the base.
- Vitrine aus gehärtetem transparentem Glas mit drei Böden. Grundgestell, Top und Sockel aus schwarz oder weiß lackiertem Holz. Versteckte Räder unter dem Sockel.
- Vitrine en verre trempé transparent à trois étagères. Base, top et socle en bois laqué blanc ou noir. Roulettes cachés sous le socle.

	I E D F	dimensioni dimension abmessungen dimension	spessore thickness stärke épaisseur	volume volume volumen volume	carico ammesso admitted load tragfähigkeit charge admise	peso weight gewicht poids	prezzo price preis prix
		cm	mm	m3	kg	kg	euro
Beryl		118 x h 120	4	0,34		60	● 1.970 ●● 2.060 ●●● 2.100
design F. Forcellini 2023							

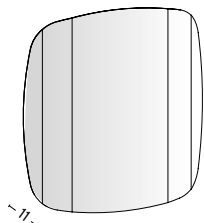

- Specchio / Mirror / Spiegel / Miroir
- Specchio fumè / Smoked mirror / Rauchglasspiegel / miroir fumé
- Specchio bronzo / Bronze mirror / Bronze Spiegel / Miroir bronze

Specchio da parete verticale o orizzontale, con struttura in legno verniciata nero. Gli specchi laterali sono inclinati.
Wall mirror vertical or horizontal with black lacquered wooden structure. The side mirrors are inclined.
Wandspiegel senkrecht oder waagrecht mit schwarz lackierter Struktur. Die Seitenspiegel sind schräg.
Miroir au mur vertical ou horizontal avec structure en bois laqué noir. Les miroirs latéraux sont inclinés.

Beryl		157 x h 160	4	0,63		98	● 2.780 ●● 2.910 ●●● 2.960
design F. Forcellini 2023							

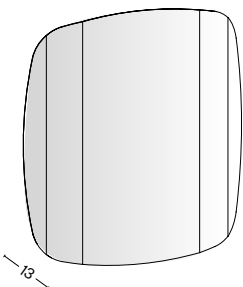

- Specchio / Mirror / Spiegel / Miroir
- Specchio fumè / Smoked mirror / Rauchglasspiegel / miroir fumé
- Specchio bronzo / Bronze mirror / Bronze Spiegel / Miroir bronze

Specchio da parete verticale o orizzontale, con struttura in legno verniciata nero. Gli specchi laterali sono inclinati.
Wall mirror vertical or horizontal with black lacquered wooden structure. The side mirrors are inclined.
Wandspiegel senkrecht oder waagrecht mit schwarz lackierter Struktur. Die Seitenspiegel sind schräg.
Miroir au mur vertical ou horizontal avec structure en bois laqué noir. Les miroirs latéraux sont inclinés.

Beryl		196 x h 200	4	1,06		137	● 3.770 ●● 3.920 ●●● 3.980
design F. Forcellini 2023							

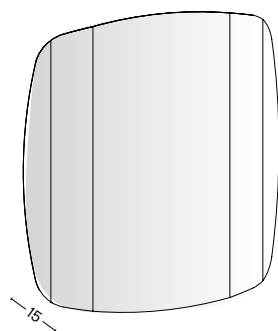

- Specchio / Mirror / Spiegel / Miroir
- Specchio fumè / Smoked mirror / Rauchglasspiegel / miroir fumé
- Specchio bronzo / Bronze mirror / Bronze Spiegel / Miroir bronze

Specchio da parete verticale o orizzontale, con struttura in legno verniciata nero. Gli specchi laterali sono inclinati.
Wall mirror vertical or horizontal with black lacquered wooden structure. The side mirrors are inclined.
Wandspiegel senkrecht oder waagrecht mit schwarz lackierter Struktur. Die Seitenspiegel sind schräg.
Miroir au mur vertical ou horizontal avec structure en bois laqué noir. Les miroirs latéraux sont inclinés.

	I E D F	dimensioni dimension abmessungen dimension	spessore thickness stärke épaisseur	volume volume volumen volume	carico ammesso admitted load tragfähigkeit charge admise	peso weight gewicht poids	prezzo price preis prix
		cm	mm	m3	kg	kg	euro
Beryl design F. Forcellini 2023		196 x h 130	4	0,68		104	● 2.860 ●● 2.940 ●●● 2.990

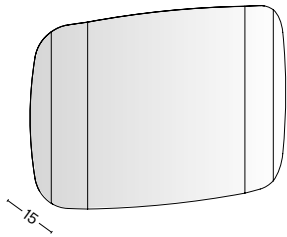

- Specchio / Mirror / Spiegel / Miroir
- Specchio fumè / Smoked mirror / Rauchglasspiegel / miroir fumé
- Specchio bronzo / Bronze mirror / Bronze Spiegel / Miroir bronze

Specchio da parete verticale o orizzontale, con struttura in legno verniciata nero. Gli specchi laterali sono inclinati.
 Wall mirror vertical or horizontal with black lacquered wooden structure. The side mirrors are inclined.
 Wandspiegel senkrecht oder waagrecht mit schwarz lackierter Struktur. Die Seitenspiegel sind schräg.
 Miroir au mur vertical ou horizontal avec structure en bois laqué noir. Les miroirs latéraux sont inclinés.

Beryl design F. Forcellini 2023		118 x h 200	4	0,55		92	● 2.740 ●● 2.880 ●●● 2.930
---	--	-------------	---	------	--	----	----------------------------------

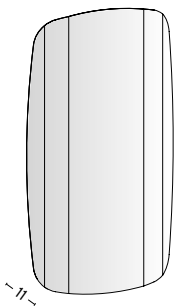

- Specchio / Mirror / Spiegel / Miroir
- Specchio fumè / Smoked mirror / Rauchglasspiegel / miroir fumé
- Specchio bronzo / Bronze mirror / Bronze Spiegel / Miroir bronze

Specchio da parete verticale o orizzontale, con struttura in legno verniciata nero. Gli specchi laterali sono inclinati.
 Wall mirror vertical or horizontal with black lacquered wooden structure. The side mirrors are inclined.
 Wandspiegel senkrecht oder waagrecht mit schwarz lackierter Struktur. Die Seitenspiegel sind schräg.
 Miroir au mur vertical ou horizontal avec structure en bois laqué noir. Les miroirs latéraux sont inclinés.

	I E D F	dimensioni dimension abmessungen dimension	spessore thickness stärke épaisseur	volume volume volumen volume	carico ammesso admitted load tragfähigkeit charge admise	peso weight gewicht poids		prezzo price preis prix
		cm	mm	m3	kg	kg		euro
Can Can design Mario Milana 2018		200 x 100 x h.75	12+6 (18)	0,34	150	124 - 154	○ 4.180	★ 4.560
		220 x 100 x h.75	15+6 (21)	0,37	150	136 - 165	○ 4.660	★ 5.040
		240 x 100 x h.75	15+6 (21)	0,40	150	148 - 178	○ 4.830	★ 5.210
		260 x 100 x h.75	15+6 (21)	0,43	150	160 - 190	○ 5.060	★ 5.440

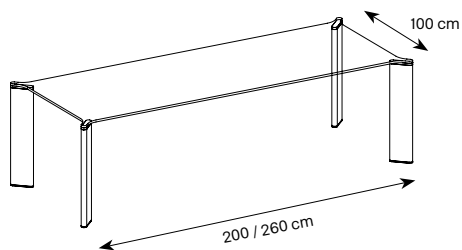

- **gambe noce canaletto** + piastre terminali **inox** / **canaletto walnut legs** + final plates in **stainless steel** / **Beine Walnuß Canaletto** + Abschlussplatten aus **Edelstahl** / **pieds en noyer canaletto** + plaques terminals **inox**.
- ★ **gambe vetro** + piastre terminali **inox** / **glass legs** + final plates in **stainless steel** / **Glasbeine** + Abschlussplatten aus **Edelstahl** / **pieds en verre** + plaques teminals **inox**.

- Tavolo con gambe in vetro **extrachiaro 40mm** o **legno noce canaletto massello**.
Top in vetro stratificato. Piastre di collegamento gambe e piedino in metallo inox.
- Dining table with legs in **40mm extra clear glass** or **solid walnut canaletto wood**.
Top in stratified glass. Connecting leg plates and final plate in stainless steel.
- Eßtisch mit Beinen aus **40mm extrahellem Glas** oder **massivem Walnuß Canaletto Holz**.
Top aus Schichtglas. Verbindungs- und Abschlussplatten der Beine aus Edelstahl.
- Table haute avec pieds en **verre extra claire 40mm** ou en **noyer canaletto massif**.
Top en verre stratifié. Plaque de liason et final des pieds en inox.

	I E D F	dimensioni dimension abmessungen dimension	spessore thickness stärke épaisseur	volume volume volumen volume	carico ammesso admitted load tragfähigkeit charge admise	peso weight gewicht poids	prezzo price preis prix
		cm	mm	m3	kg	kg	euro

Central 160

design F. Forcellini 2020

160 x 16 x h 160	4	1,08		105	● 2.940
					●● 3.160
					●●● 3.220
					●●●● 3.950

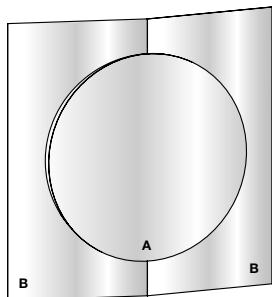

- Specchio / Mirror / Spiegel / Miroir
- Specchio fumè / Smoked mirror / Rauchglasspiegel / miroir fumé
- Specchio bronzo / Bronze mirror / Bronze Spiegel / Miroir bronze
- Specchio oro / Gold mirror / Gold Spiegel / miroir or

	B - Pannelli Esterni / external panels / Äußere Platten / Panneaux extérieurs			
	Specchio Mirror Spiegel Miroir	Specchio fumè Smoked mirror Rauchglasspiegel miroir fumé	Specchio bronzo Bronze mirror Bronze Spiegel Miroir bronze	Specchio oro Gold mirror Gold Spiegel miroir or
A - Pannello Centrale Central panel / Zentrale Platte Panneau Central	160 x 160			
Specchio / Mirror / Spiegel / Miroir	euro 2.940	euro 3.100	euro 3.140	euro 3.580
Specchio fumè / Smoked mirror Rauchglasspiegel / miroir fumé	euro 3.050	euro 3.160	euro 3.210	euro 3.650
Specchio bronzo / Bronze mirror Bronze Spiegel / Miroir bronze	euro 3.070	euro 3.190	euro 3.220	euro 3.690
Specchio oro / Gold mirror Gold Spiegel / miroir or	euro 3.290	euro 3.450	euro 3.480	euro 3.950

Central 200

design F. Forcellini 2019

200 x 18 x h 200	4	1,35		131	● 3.660
					●● 3.960
					●●● 4.010
					●●●● 4.880

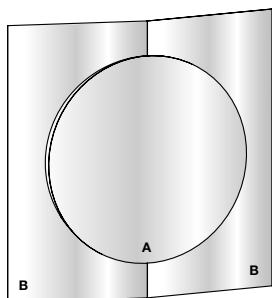

- Specchio / Mirror / Spiegel / Miroir
- Specchio fumè / Smoked mirror / Rauchglasspiegel / miroir fumé
- Specchio bronzo / Bronze mirror / Bronze Spiegel / Miroir bronze
- Specchio oro / Gold mirror / Gold Spiegel / miroir or

	B - Pannelli Esterni / external panels / Äußere Platten / Panneaux extérieurs			
	Specchio Mirror Spiegel Miroir	Specchio fumè Smoked mirror Rauchglasspiegel miroir fumé	Specchio bronzo Bronze mirror Bronze Spiegel Miroir bronze	Specchio oro Gold mirror Gold Spiegel miroir or
A - Pannello Centrale Central panel / Zentrale Platte Panneau Central	200 x 200			
Specchio / Mirror / Spiegel / Miroir	euro 3.660	euro 3.880	euro 3.920	euro 4.470
Specchio fumè / Smoked mirror Rauchglasspiegel / miroir fumé	euro 3.780	euro 3.960	euro 3.990	euro 4.580
Specchio bronzo / Bronze mirror Bronze Spiegel / Miroir bronze	euro 3.830	euro 4.000	euro 4.010	euro 4.620
Specchio oro / Gold mirror Gold Spiegel / miroir or	euro 4.110	euro 4.310	euro 4.350	euro 4.880

Specificare sempre la finitura degli specchi esterni (B) e dello specchio centrale (A)
Always specify finish of exterior mirrors (B) and central mirror (A)
Immer Ausführung der externen Spiegel (B) und des zentralen Spiegel angeben (A)
Spécifier toujours finition des miroirs extérieurs (B) et du miroir central (A)

- Specchio da parete formato da due pannelli esterni leggermente inclinati e da uno rotondo centrale. Disponibile in specchio, specchio fumè, bronzo o oro. Si possono avere i pannelli con due finiture di specchio differenti. La struttura è sempre nera.
- Wall mirror made of two slightly tilted external panels and a round central panel. Panels can be of two different finishes. Available in mirror, smoked, bronze or gold mirror. Black supporting frame.
- Wandspiegel aus zwei äußeren leicht schrägen Platten und einer runden zentralen Platte. Verfügbar in Spiegel, Rauchglasspiegel, Bronze oder Gold Spiegel. Die Platten können aus zwei verschiedenen Ausfertigungen sein. Struktur immer schwarz.
- Miroir au mur composé de deux panneaux extérieurs légèrement inclinés et un ronde central. Disponible en miroir, miroir fumé, bronze ou or. Panneaux peuvent être en deux finitions différents. Structure toujours noir.

	I E D F	dimensioni dimension abmessungen dimension	spessore thickness stärke épaisseur	volume volume volumen volume	carico ammesso admitted load tragfähigkeit charge admise	peso weight gewicht poids	prezzo price preis prix
		cm	mm	m3	kg	kg	euro

Comò alto Comò basso

design Marco Gaudenzi 1994

A 113 x 45 x h 65	10 / 12 / 15	0,623	70 + 20*	108	1.680 □ 1.980
B 113 x 45 x h 40	10 / 12 / 15	0,350	80 + 20*	69	1.280 □ 1.510

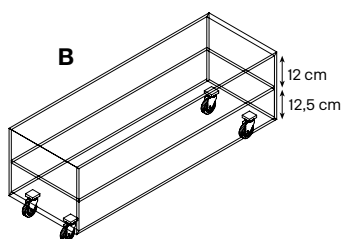
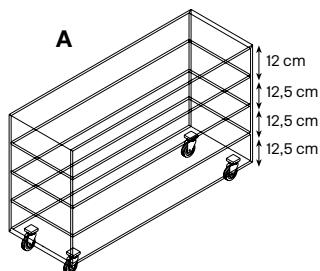

* Ogni ripiano / On each shelf / Auf jedem Bord / Pour chaque étagère
□ versione extrachiario / extraclear version / version extrahell / version extra-claire

- Mobile multiuso su base con ruote.
- Glass-unit for various uses on castors.
- Mehrwertige Glaskommode auf Basis mit Rädern.
- Meuble à multiples emplois sur base avec roulettes.

Cassetti / Drawer / Schublade / Tiroir

U 54,5 x 44,5 x h 12

U

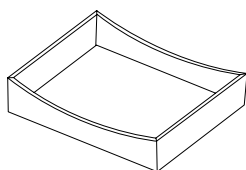

wengè	0,068	5	300
rovere sbiancato bleached oak gebleichtes Eichenholz rouvre blanchi	0,068	5	290
noce canaletto canaletto walnut Walnuß canaletto noyer canaletto	0,068	5	320
RAL	0,068	5	295

H

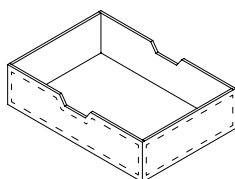

H 54,5 x 44,5 x h 12

Cassetto cuoio naturale o nero Natural or black leather drawer Schublade in Leder natur oder schwarz Tiroir en cuir naturel ou noir	0,068	5	540
--	-------	---	------------

	I E D F	dimensioni dimension abmessungen dimension	spessore thickness stärke épaisseur	volume volume volumen volume	carico ammesso admitted load tragfähigkeit charge admise	peso weight gewicht poids	prezzo price preis prix
		cm	mm	m3	kg	kg	euro

Crossover

design Massimo Castagna 2021

220 x 130 x h 75	B 10+10 T 15/10+6	0,641	150	248	□ 7.380 ■ 8.390 ■ 8.490
240 x 130 x h 75	B 10+10 T 15/10+6	0,670	150	260	□ 7.620 ■ 8.640 ■ 8.750
260 x 130 x h 75	B 10+10 T 15/10+6	0,699	150	272	□ 7.840 ■ 8.880 ■ 9.000

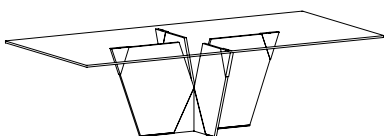

280 x 130 x h 75	B 10+10 T 15/10+6	0,747	150	301	□ 8.240 ■ 9.390 ■ 9.530
300 x 130 x h 75	B 10+10 T 15/10+6	0,776	150	313	□ 8.360 ■ 9.550 ■ 9.700
320 x 130 x h 75	B 10+10 T 15/10+6	0,805	150	325	□ 8.560 ■ 9.810 ■ 9.980

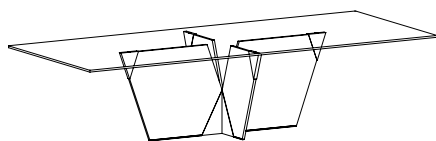

- top e basamento vetro extrachiaro / extra clear glass top and base
Top und Gestell aus extrahellem Glas / top et piètement en verre extra clair
- top e basamento vetro fumè / smoked glass top and base
Top und Gestell aus Rauchglas / top et piètement en verre fumé
- top e basamento vetro bronzo / bronze glass top and base
Top und Gestell aus Bronze Glas / top et piètement en verre bronze

Specificare sempre la finitura esterna delle parti metalliche.
Always specify external finish of metal part.
Immer Anfertigung der Außenseite der Metallteile angeben.
Indiquer toujours finition extérieur des parties en métal.

- Tavolo con basamento centrale in vetro stratificato 10+10mm, caratterizzato da un giunto piramidale in metallo e supporti top in finitura canna di fucile lucido o Titanio spazzolato opaco.
Top e basamento in vetro extrachiaro, fumè e bronzo. I tops in vetro fumè e bronzo sono sempre stratificati.
- Table with central base made of stratified glass 10+10mm, featuring a pyramidal metal joint and top supports in polished gunmetal or matt brushed titanio.
Top and base in extra clear, smoked or bronze glass. Table tops in smoked or bronze glass are always stratified.
- Tisch mit zentralem Gestell aus Schichtglas 10+10mm, pyramidenförmiges Verbindungsstück aus Metall und Topplattenträger in glänzendem Gunmetal oder matt gebürstetem Titanio.
Top und Gestell aus extrahellem, Rauch- oder Bronze Glas. Topplatten aus Rauch- oder Bronze Glas sind immer aus Schichtglas.
- Table avec piètement central en verre stratifié 10+10mm, marqué par un joint pyramidal et supports top en finition gunmetal brillant ou titanio brossé mat.
Top et piètement en verre extra clair, fumé ou bronze. Les tops en verre fumé ou bronze sont toujours en verre stratifié.

	I E D F	dimensioni dimension abmessungen dimension	spessore thickness stärke épaisseur	volume volume volumen volume	carico ammesso admitted load tragfähigkeit charge admise	peso weight gewicht poids	prezzo price preis prix
		cm	mm	m3	kg	kg	euro
Crossover design Massimo Castagna 2021		210 x 160 x h 75	B 10+10 T 15/10+6	0,693	150	247 □ 7.770 ■ 8.810 ■ 8.940	
		260 x 130 x h 75	B 10+10 T 15/10+6	0,699	150	244 □ 7.880 ■ 8.930 ■ 9.070	
		300 x 130 x h 75	B 10+10 T 15/10+6	0,776	150	280 □ 8.410 ■ 9.650 ■ 9.810	

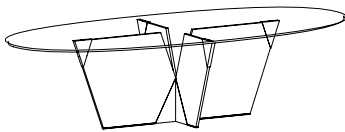
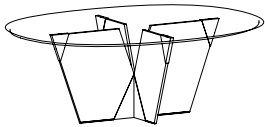

		300 x 130 x h 75	B 10+10 T 15/10+6	0,776	150	280 □ 8.410 ■ 9.650 ■ 9.810	
--	--	------------------	-------------------	-------	-----	-----------------------------	--

- top e basamento vetro extrachiaro / extra clear glass top and base
Top und Gestell aus extrahellem Glas / top et piètement en verre extra clair
- top e basamento vetro fumè / smoked glass top and base
Top und Gestell aus Rauchglas / top et piètement en verre fumé
- top e basamento vetro bronzo / bronze glass top and base
Top und Gestell aus Bronze Glas / top et piètement en verre bronze

Specificare sempre la finitura esterna delle parti metalliche.
Always specify external finish of metal part.
Immer Anfertigung der Außenseite der Metallteile angeben.
Indiquer toujours finition extérieur des parties en métal.

- Tavolo con basamento centrale in vetro stratificato 10+10mm, caratterizzato da un giunto piramidale in metallo e supporti top in finitura canna di fucile lucido o Titanio spazzolato opaco.
Top e basamento in vetro extrachiaro, fumè e bronzo. I tops in vetro fumè e bronzo sono sempre stratificati.
- Table with central base made of stratified glass 10+10mm, featuring a pyramidal metal joint and top supports in polished gunmetal or matt brushed titanio.
Top and base in extra clear, smoked or bronze glass. Table tops in smoked or bronze glass are always stratified.
- Tisch mit zentralem Gestell aus Schichtglas 10+10mm, pyramidenförmiges Verbindungsstück aus Metall und Topplattenträger in glänzendem Gunmetal oder matt gebürstetem Titanio.
Top und Gestell aus extrahellem, Rauch- oder Bronze Glas. Topplatten aus Rauch- oder Bronze Glas sind immer aus Schichtglas.
- Table avec piètement central en verre stratifié 10+10mm, marqué par un joint pyramidal et supports top en finition gunmetal brillant ou titanio brossé mat.
Top et piètement en verre extra clair, fumé ou bronze. Les tops en verre fumé ou bronze sont toujours en verre stratifié.

	I E D F	dimensioni dimension abmessungen dimension	spessore thickness stärke épaisseur	volume volume volumen volume	carico ammesso admitted load tragfähigkeit charge admise	peso weight gewicht poids	prezzo price preis prix
		cm	mm	m3	kg	kg	euro

Crossover

design Massimo Castagna 2021

150 x 150 x h 75	B 10+10 T 15/10+6	0,554	150	210	<input type="checkbox"/> 6.830	<input checked="" type="checkbox"/> 7.540	<input type="checkbox"/> 7.620
------------------	-------------------	-------	-----	-----	--------------------------------	---	--------------------------------



180 x 180 x h 75	B 10+10 T 15/10+6	0,701	150	286	<input type="checkbox"/> 7.950	<input checked="" type="checkbox"/> 9.020	<input type="checkbox"/> 9.140
------------------	-------------------	-------	-----	-----	--------------------------------	---	--------------------------------

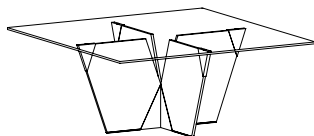

- top e basamento vetro extrachiaro / extra clear glass top and base
Top und Gestell aus extrahellem Glas / top et piètement en verre extra clair
- top e basamento vetro fumè / smoked glass top and base
Top und Gestell aus Rauchglas / top et piètement en verre fumé
- top e basamento vetro bronzo / bronze glass top and base
Top und Gestell aus Bronze Glas / top et piètement en verre bronze

Specificare sempre la finitura esterna delle parti metalliche.
Always specify external finish of metal part.
Immer Anfertigung der Außenseite der Metallteile angeben.
Indiquer toujours finition extérieur des parties en métal.

- Tavolo con basamento centrale in vetro stratificato 10+10mm, caratterizzato da un giunto piramidale in metallo e supporti top in finitura canna di fucile lucido o Titanio spazzolato opaco.
Top e basamento in vetro extrachiaro, fumè e bronzo. I tops in vetro fumè e bronzo sono sempre stratificati.
- Table with central base made of stratified glass 10+10mm, featuring a pyramidal metal joint and top supports in polished gunmetal or matt brushed titanium.
Top and base in extra clear, smoked or bronze glass. Table tops in smoked or bronze glass are always stratified.
- Tisch mit zentralem Gestell aus Schichtglas 10+10mm, pyramidenförmiges Verbindungsstück aus Metall und Topplattenträger in glänzendem Gunmetal oder matt gebürstetem Titanio.
Top und Gestell aus extrahellem, Rauch- oder Bronze Glas. Topplatten aus Rauch- oder Bronze Glas sind immer aus Schichtglas.
- Table avec piètement central en verre stratifié 10+10mm, marqué par un joint pyramidal et supports top en finition gunmetal brillant ou titanio brossé mat.
Top et piètement en verre extra clair, fumé ou bronze. Les tops en verre fumé ou bronze sont toujours en verre stratifié.

	I E D F	dimensioni dimension abmessungen dimension	spessore thickness stärke épaisseur	volume volume volumen volume	carico ammesso admitted load tragfähigkeit charge admise	peso weight gewicht poids	prezzo price preis prix
		cm	mm	m3	kg	kg	euro

Crossover

design Massimo Castagna 2021

240 x 130 x h 75	B 10+10 T 15/10+6	0,670	150	253	□ 7.760 ■ 8.780 ■ 8.890
------------------	-------------------	-------	-----	-----	-------------------------

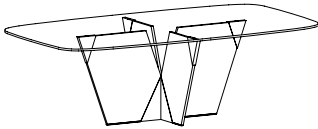

280 x 130 x h 75	B 10+10 T 15/10+6	0,747	150	293	□ 8.250 ■ 9.400 ■ 9.540
320 x 130 x h 75	B 10+10 T 15/10+6	0,805	150	317	□ 8.570 ■ 9.820 ■ 9.990

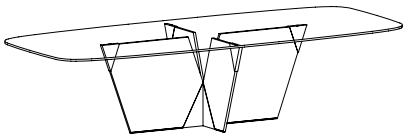

- top e basamento vetro extrachiaro / extra clear glass top and base
Top und Gestell aus extrahellem Glas / top et piètement en verre extra clair
- top e basamento vetro fumè / smoked glass top and base
Top und Gestell aus Rauchglas / top et piètement en verre fumé
- top e basamento vetro bronzo / bronze glass top and base
Top und Gestell aus Bronze Glas / top et piètement en verre bronze

Specificare sempre la finitura esterna delle parti metalliche.
Always specify external finish of metal part.
Immer Anfertigung der Außenseite der Metallteile angeben.
Indiquer toujours finition extérieur des parties en métal.

- Tavolo con basamento centrale in vetro stratificato 10+10mm, caratterizzato da un giunto piramidale in metallo e supporti top in finitura canna di fucile lucido o Titanio spazzolato opaco.
Top e basamento in vetro extrachiaro, fumè e bronzo. I tops in vetro fumè e bronzo sono sempre stratificati.
- Table with central base made of stratified glass 10+10mm, featuring a pyramidal metal joint and top supports in polished gunmetal or matt brushed titano.
Top and base in extra clear, smoked or bronze glass. Table tops in smoked or bronze glass are always stratified.
- Tisch mit zentralem Gestell aus Schichtglas 10+10mm, pyramidenförmiges Verbindungsstück aus Metall und Topplattenträger in glänzendem Gunmetal oder matt gebürstetem Titanio.
Top und Gestell aus extrahellem, Rauch- oder Bronze Glas. Topplatten aus Rauch- oder Bronze Glas sind immer aus Schichtglas.
- Table avec piètement central en verre stratifié 10+10mm, marqué par un joint pyramidal et supports top en finition gunmetal brillant ou titanio brossé mat.
Top et piètement en verre extra clair, fumé ou bronze. Les tops en verre fumé ou bronze sont toujours en verre stratifié.

	I E D F	dimensioni dimension abmessungen dimension	spessore thickness stärke épaisseur	volume volume volumen volume	carico ammesso admitted load tragfähigkeit charge admise	peso weight gewicht poids	prezzo price preis prix
		cm	mm	m3	kg	kg	euro

Dappertutto

design Marco Gaudenzi 1998

30 x 33 x h 98	5 / 12	0,20	18	35	880
30 x 33 x h 56	5 / 12	0,12	15	22	660

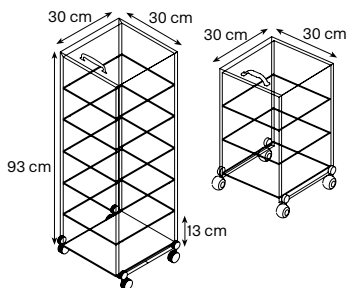

- Mobile multiuso su ruote a 3 o 6 ripiani in vetro trasparente.
- Multipurpose trolley with 3 or 6 shelves in transparent glass.
- Mehrzweck Glaskommode auf Rädern mit 3 oder 6 Fächern aus transparentem Glas.
- Meuble à multiples emplois avec 3 ou 6 étagères en verre transparent.

Dappertutto

design Marco Gaudenzi 1995

30 x 33 x h 122	5 / 12	0,28	24	42	980
30 x 33 x h 150	5 / 12	0,33	30	51	1.140

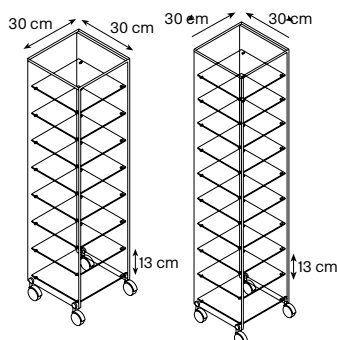

- Mobile multiuso su ruote a 8 o 10 ripiani in vetro trasparente.
- Multipurpose trolley with 8 or 10 shelves in transparent Glas.
- Mehrzweck Glaskommode auf Rädern mit 8 oder 10 Fächern aus transparentem Glas.
- Meuble à multiples emplois avec 10 ou 10 étagères en verre transparent.

	I	dimensioni	spessore	volume	carico ammesso	peso	prezzo
	E	dimension	thickness	volume	admitted load	weight	price
	D	abmessungen	stärke	volumen	tragfähigkeit	gewicht	preis
	F	dimension	épaisseur	volume	charge admise	poids	prix
		cm	mm	m3	kg	kg	euro

Dazibao design Gonzo - Vicari 2007	A 180 x 25 x h 120	12	0,66	10 *	97	3.060
	B 120 x 25 x h 180	12	0,66	10 *	97	3.060

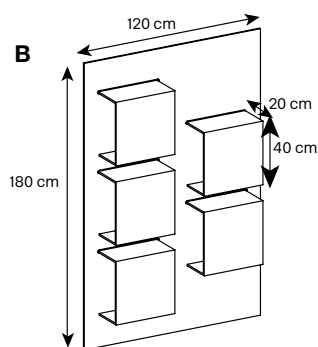
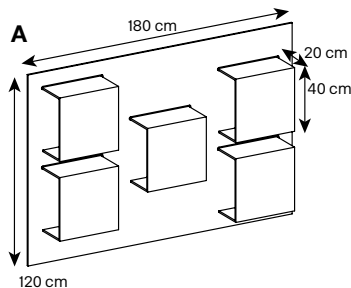

Vetro extrachiaro / extra clear glass / extrahelles Glas / verre extra clair
* ogni ripiano / on each shelf / auf jedem Bord / pour chaque étagère

- Specificare versione orizzontale (A) o verticale (B).
- Specify if horizontal (A) or vertical (B) version.
- Version bestimmen, ob horizontal (A) oder vertikal (B).
- Spécifier version, si horizontal (A) ou vertical (B).

- Contenitore a pannello in legno laccato bianco o nero opaco. Disponibile nella versione verticale o orizzontale.
- Container with matt white or black lacquered wooden panel. Available in vertical or horizontal version.
- Behälter mit Holzpanel matt schwarz oder weiß lackiert. Senkrecht oder waagrecht erhältlich.
- Récipient avec panneau en bois laqué noir ou blanc mat. Disponible en version vertical ou horizontal.

Dazibao Wood design Gonzo - Vicari 2007 / 2014	A 180 x 25 x h 120	12	0,66	10 *	97	2.860
	B 120 x 25 x h 180	12	0,66	10 *	97	2.860

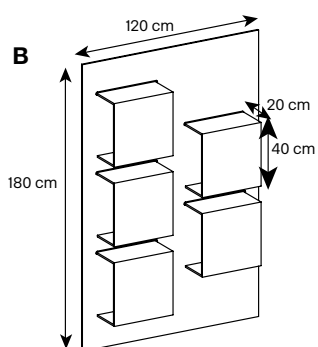
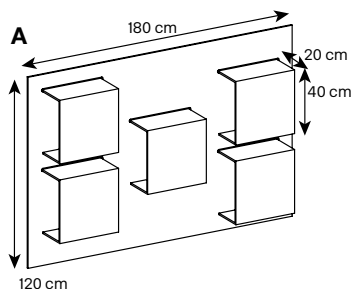

Vetro extrachiaro / extra clear glass / extrahelles Glas / Verre extra clair
* ogni ripiano / on each shelf / auf jedem Bord / pour chaque étagère

- Specificare versione orizzontale (A) o verticale (B).
- Specify if horizontal (A) or vertical (B) version.
- Version bestimmen, ob horizontal (A) oder vertikal (B).
- Spécifier version, si horizontal (A) ou vertical (B).

- Contenitore a pannello in legno **FINITURA NOCE CANALETTO**. Disponibile nella versione orizzontale e verticale.
- Container with wooden panel **FINISH WALNUT CANALETTO**. Available in vertical or horizontal version.
- Behälter mit Holzpanel in **WALNUSS CANALETTO**. Senkrecht oder waagrecht erhältlich.
- Récipient avec panneau en **BOIS NOYER CANALETTO**. Disponible en version vertical ou horizontal.

	I E D F	dimensioni dimension abmessungen dimension	spessore thickness stärke épaisseur	volume volume volumen volume	carico ammesso admitted load tragfähigkeit charge admise	peso weight gewicht poids	prezzo price preis prix
		cm	mm	m3	kg	kg	euro

Dekon 2

150 x 68 x h 36

12

0,68

30

56

1.360

□ 1.470

■ 1.580

design Karim Rashid 2006

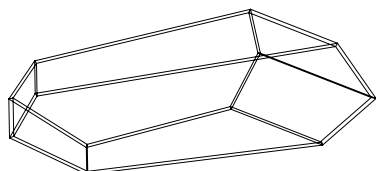

- Vetro extrachiaro / extra clear glass / extrahelles Glas / verre extra clair
- Vetro fumé / smoked glass / Rauchglas / verre fumé

- Tavolo basso in vetro trasparente, extrachiaro o fume'.
- Small table in transparent, extra clear or smoked glass.
- Niedriger Tisch aus transparentem, extrahellem Glas oder Rauchglas.
- Table basse en verre transparent, extra clair ou fume'.

	I E D F	dimensioni dimension abmessungen dimension	spessore thickness stärke épaisseur	volume volume volumen volume	carico ammesso admitted load tragfähigkeit charge admise	peso weight gewicht poids	prezzo price preis prix
		cm	mm	m3	kg	kg	euro

Doors

80 x h 160 x 10

4

0,29

65

1.680

design Matteo Ragni 2017

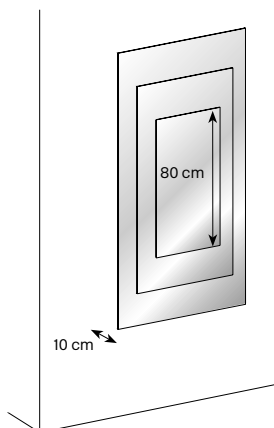

Optional illuminazione led con telecomando / Optional led lighting with remote control.
Option Illumination Led avec télécommande / Optionale Led Beleuchtung mit Fernbedienung.

650

**SPECIFICARE SEMPRE IL COLORE DELLA STRUTTURA.
ALWAYS SPECIFY COLOUR OF STRUCTURE.
IMMER DIE FARBE DER STRUKTUR ANGEBEN.
SPECIFIER TOUJOURS COULEUR STRUCTURE.**

- Specchio da parete con struttura bianca o nera. Disponibile impianto illuminazione led sul retro.
- Wall mirror with white or black structure. Led lighting system for the back available.
- Wandspiegel mit weißer oder schwarzer Struktur. Beleuchtungsanlage mit Led für die Rückseite erhältlich.
- Miroir à mur avec structure blanc ou noir. Disponible équipement d'illumination Led sur le dos.

Doors

100 x h 230 x 10

4

0,49

120

2.860

design Matteo Ragni 2017

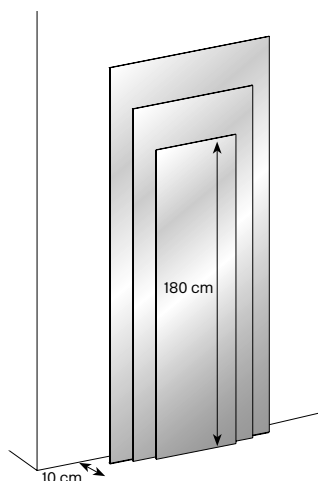

Optional illuminazione led con telecomando / Optional led lighting with remote control.
Option Illumination Led avec télécommande / Optionale Led Beleuchtung mit Fernbedienung.

840

**SPECIFICARE SEMPRE IL COLORE DELLA STRUTTURA.
ALWAYS SPECIFY COLOUR OF STRUCTURE.
IMMER DIE FARBE DER STRUKTUR ANGEBEN.
SPECIFIER TOUJOURS COULEUR STRUCTURE.**

- Specchio da parete a terra con struttura bianca o nera. Disponibile impianto illuminazione led sul retro.
- Floor wall mirror with white or black structure. Led lighting system for the back available.
- Auf den Boden stehender Wandspiegel mit weißer oder schwarzer Struktur. Beleuchtungsanlage mit Led für die Rückseite erhältlich.
- Miroir à mur au sol avec structure blanc ou noir. Disponible équipement d'illumination Led sur le dos.

	I E D F	dimensioni dimension abmessungen dimension	spessore thickness stärke épaisseur	volume volume volumen volume	carico ammesso admitted load tragfähigkeit charge admise	peso weight gewicht poids	prezzo price preis prix
		cm	mm	m3	kg	kg	euro

East side

Bartoli design 2019

200 x 46 x h 70	5/6/8	0,47	100	112	5.460
-----------------	-------	------	-----	-----	-------

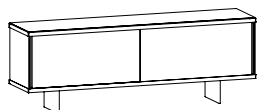

Optional ripiano interno 95 x42 cm in vetro fumè / **optional** internal shelf 95 x42 cm in smoked glass **200**
optionales internes Regal 95 x42 cm aus Rauchglas / **option** étagère intérieur 95 x42 cm en verre fumé

Optional illuminazione led sotto la base con telecomando / **optional** led lighting underneath the bottom with remote control / **optionale** Led Beleuchtung unter dem Boden mit Fernbedienung **610**
option illumination led sous la base avec télécommande

240 x 46 x h 70	5/6/8	0,54	100	134	6.400
-----------------	-------	------	-----	-----	-------

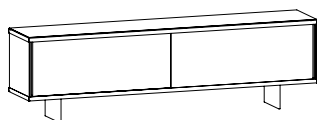

Optional ripiano interno 115 x42 cm in vetro fumè / **optional** internal shelf 115 x42 cm in smoked glass **220**
optionales internes Regal 115 x42 cm aus Rauchglas / **option** étagère intérieur 115 x42 cm en verre fumé

Optional illuminazione led sotto la base con telecomando / **optional** led lighting underneath the bottom with remote control / **optionale** Led Beleuchtung unter dem Boden mit Fernbedienung **650**
option illumination led sous la base avec télécommande

Specificare sempre la finitura del profilo e del top in marmo.
Always specify profile and top marble finish
Immer Ausführung des Profil und des Top in Marmor angeben.
Toujours spécifier finition profil et top en marbre.

36 x 42 x h 40 cm

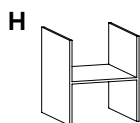

H **Optional** separatore in finitura laccato nero opaco / **optional** partition in matt black lacquer **270**
optionale Trennwand matt schwarz lackiert / **option** cloison laqué noir mat

H **Optional** separatore in noce canaletto / **optional** partition in walnut canaletto **340**
optionale Trennwand in Nußbaum Canaletto / **option** cloison en noyer canaletto

H **Optional** separatore in finitura laccato RAL opaco / **optional** partition in matt RAL lacquer **320**
optionale Trennwand matt RAL lackiert / **option** cloison laqué RAL mat

- Madia in vetro fumè disponibile in due larghezze. Il profilo per l'anta scorrevole, la maniglia e i piedi h 20 cm possono essere in bronzo spazzolato o nero spazzolato. Il top è disponibile in marmo verde Guatemala e rosso Arabescato. Optional internal shelf in smoked glass, separatore interno in legno e luce led con telecomando.
- Sideboard in smoked glass available in two widths. Profile for sliding door, handle and feet h 20 cm can be in brushed bronze or brushed black. Top available in green Guatemala or red Arabesque marble. Optional internal shelf in smoked glass, internal wooden partition and led lighting with remote control.
- Anrichte aus Rauchglas in zwei Breiten. Profil für Schiebetür, Griff und Füße h 20 cm können aus gebürsteter Bronze oder schwarz gebürstet sein. Top aus grünem Guatemala oder rotem Arabesque Marmor. Optional: internes Regal aus Rauchglas, interne Trennwand aus Holz, Led Beleuchtung mit Fernbedienung.
- Sideboard en verre fumé disponible en deux largeurs. Profil de la porte coulissante, pommeau et pieds h 20 cm disponible en bronze brossé ou noir brossé. Top disponible en marbre vert Guatemala ou rouge Arabesque. Option: étagère intérieur en verre fumé, cloison en bois et illumination led avec télécommande.

	I E D F	dimensioni dimension abmessungen dimension	spessore thickness stärke épaisseur	volume volume volumen volume	carico ammesso admitted load tragfähigkeit charge admise	peso weight gewicht poids	prezzo price preis prix
		cm	mm	m3	kg	kg	euro

East side

110 x 46 x h 130	5/6/8	0,43	100/*15	107	4.960
------------------	-------	------	---------	-----	-------

Bartoli design 2019

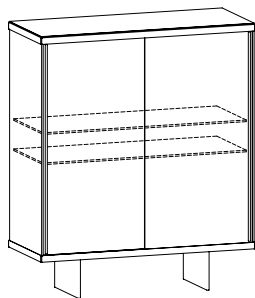

Optional ripiano interno 104 x 42 cm in vetro fumè / **optional** internal shelf 104 x 42 cm in smoked glass **210**
optionales internes Regal 104 x 42 cm aus Rauchglas / **option** étagère intérieur 104 x 42 cm en verre fumé

Optional illuminazione led sotto la base con telecomando / **optional** led lighting underneath the bottom **530**
with remote control / **optionale** Led Beleuchtung unter dem Boden mit Fernbedienung
option illumination led sous la base avec télécommande

Specificare sempre la finitura del profilo e del top in marmo.
Always specify profile and top marble finish
Immer Ausführung des Profil und des Top in Marmor angeben.
Toujours spécifier finition profil et top en marbre.

* ogni ripiano / on each shelf / auf jedem Bord / pour chaque étagère

36 x 42 x h 40 cm

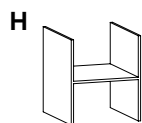

H **Optional** separatore in finitura laccato nero opaco / **optional** partition in matt black lacquer **270**
optionale Trennwand matt schwarz lackiert / **option** cloison laqué noir mat

H **Optional** separatore in noce canaletto / **optional** partition in walnut canaletto **340**
optionale Trennwand in Nußbaum Canaletto / **option** cloison en noyer canaletto

H **Optional** separatore in finitura laccato RAL opaco / **optional** partition in matt RAL lacquer **320**
optionale Trennwand matt RAL lackiert / **option** cloison laqué RAL mat

- Madia in vetro fumè con due ripiani interni regolabili in altezza. Il profilo per l'anta scorrevole, la maniglia e i piedi h 20 cm possono essere in bronzo spazzolato o nero spazzolato. Il top è disponibile in marmo verde Guatemala e rosso Arabescato. Optional ripiano interno in vetro fumè, separatore interno in legno e luce led con telecomando.
- Sideboard in smoked glass with two adjustable internal shelves. Profile for sliding door, handle and feet h 20 cm available in brushed bronze or brushed black. Top available in green Guatemala or red Arabesque marble. Optional internal shelf in smoked glass, internal wood partition and led lighting with remote control
- Anrichte aus Rauchglas mit zwei verstellbaren Regalen. Profil der Schiebetür, Griff und Füße h 20 cm können aus gebürsteter Bronze oder schwarz gebürstet sein. Top aus grünem Guatemala oder rotem Arabesque Marmor. Optional: internes Regal aus Rauchglas, interne Trennwand aus Holz und Led Beleuchtung mit Fernbedienung.
- Sideboard en verre fumé avec deux étagères réglables en hauteur. Profil de la porte coulissante, pommeau et pieds h 20 cm disponible en bronze brossé ou noir brossé. Top disponible en marbre vert Guatemala ou rouge Arabesque. Option: étagère intérieur en verre fumé, cloison en bois et illumination led avec télécommande.

	I E D F	dimensioni dimension abmessungen dimension	spessore thickness stärke épaisseur	volume volume volumen volume	carico ammesso admitted load tragfähigkeit charge admise	peso weight gewicht poids	prezzo price preis prix
		cm	mm	m3	kg	kg	euro

Eden

design M. U.

90 x 90 x h 40	15	0,562	50	62	1.240
118 x 88 x h 40	15	0,702	50	72	□ 1.370
128 x 68 x h 40	15	0,596	50	63	1.380
100 x 60 x h 40	15	0,380	50	45	□ 1.520
					1.170
					□ 1.290
					1.070
					□ 1.180

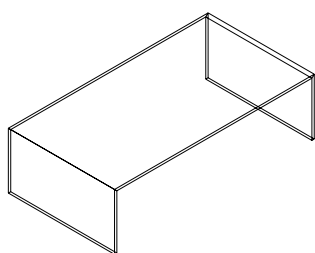

□ Vetro extrachiaro / extra clear glass / extrahelles Glas / verre extra clair

- Tavolino a ponte. Disponibili con dimensioni a richiesta.
- Coffee table. Special sizes available.
- Tisch-Brücke. Sonderanfertigungen sind möglich.
- Table à pont. Dimensions spéciales sur demande.

Elica

design Isao Hosoe 1989

Ø 50 x h 60	12	0,391	40	42	1.830
Ø 70 x h 51	12	0,536	40	67	1.920

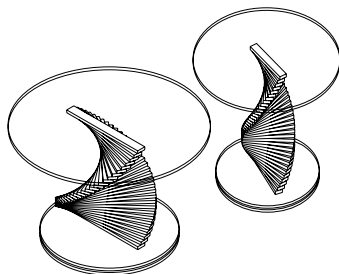

- Tavolino basso a colonna centrale in listelli di cristallo sovrapposti, base rotante su sfere di acciaio.
- Small table with central column made of stacked glass strips, revolving base on steel ball bearings.
- Niedriger Tisch mit zentraler Säule aus gestapelten Glasleisten, drehbarem Fuß auf Stahkugeln.
- Table basse avec support central en barrettes de cristal superposées, base pivotante sur billes en acier.

	I E D F	dimensioni dimension abmessungen dimension	spessore thickness stärke épaisseur	volume volume volumen volume	carico ammesso admitted load tragfähigkeit charge admise	peso weight gewicht poids	prezzo price preis prix
		cm	mm	m3	kg	kg	euro

Farniente alto quadrato

design G.T. Garattoni 2005/2019

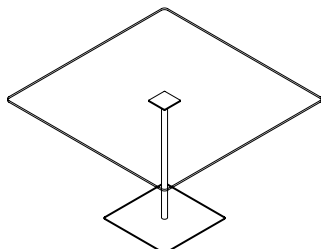

90 x 90 x h 73	12	0,123	120	50	1.560
					<input type="checkbox"/> 1.620
					<input checked="" type="checkbox"/> 1.660
110 x 110 x h 73	12	0,180	120	70	1.670
					<input type="checkbox"/> 1.800
					<input checked="" type="checkbox"/> 1.860

Maggiorazione basamento in finitura: **canna di fucile**

Upcharge base in **gunmetal**

Aufpreis für Gestell in **Gunmetal**

Surcharge pour piètement en **gunmetal**

330

Vetro extrachiaro / extra clear glass / extrahelles Glas / verre extra clair

Vetro fumé / smoked glass / Rauchglas / verre fumé

Farniente alto rettangolare

design G.T. Garattoni 2005 /2019

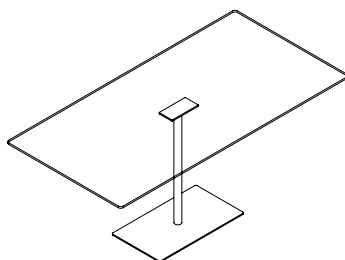

130 x 70 x h 73	12	0,183	120	68	1.650
					<input type="checkbox"/> 1.780
					<input checked="" type="checkbox"/> 1.790
150 x 80 x h 73	12	0,185	120	75	1.740
					<input type="checkbox"/> 1.890
					<input checked="" type="checkbox"/> 1.910

Maggiorazione basamento in finitura: **canna di fucile**

Upcharge base in **gunmetal**

Aufpreis für Gestell in **Gunmetal**

Surcharge pour piètement en **gunmetal**

330

Vetro extrachiaro / extra clear glass / extrahelles Glas / verre extra clair

Vetro fumé / smoked glass / Rauchglas / verre fumé

Farniente alto tondo

design G.T. Garattoni 2005 /2019

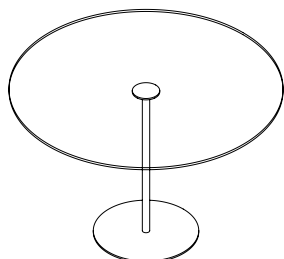

Ø 70 x h 73	12	0,100	120	38	1.400
					<input type="checkbox"/> 1.450
					<input checked="" type="checkbox"/> 1.480
Ø 90 x h 73	12	0,123	120	45	1.580
					<input type="checkbox"/> 1.670
					<input checked="" type="checkbox"/> 1.710
Ø 110 x h 73	12	0,180	120	68	1.680
					<input type="checkbox"/> 1.820
					<input checked="" type="checkbox"/> 1.860
Ø 120 x h 73	12	0,190	120	75	1.780
					<input type="checkbox"/> 1.920
					<input checked="" type="checkbox"/> 1.980

Maggiorazione basamento in finitura: **canna di fucile**

Upcharge base in **gunmetal**

Aufpreis für Gestell in **Gunmetal**

Surcharge pour piètement en **gunmetal**

330

Vetro extrachiaro / extra clear glass / extrahelles Glas / verre extra clair

Vetro fumé / smoked glass / Rauchglas / verre fumé

-Tavolo in vetro trasparente, extrachiaro o fumé con basamento in metallo in finitura cromata o canna di fucile.

- Dining table in transparent, extra clear or smoked glass with metal base in chrome or gunmetal.

- Esstisch aus transparentem, extrahellem Glas oder Rauchglas mit Metallgestell verchromt oder Gunmetal.

- Table en verre transparent, extra clair ou fumé avec piètement en métal chromé ou gunmetal.

	I E D F	dimensioni dimension abmessungen dimension	spessore thickness stärke épaisseur	volume volume volumen volume	carico ammesso admitted load tragfähigkeit charge admise	peso weight gewicht poids	prezzo price preis prix
		cm	mm	m3	kg	kg	euro

Farniente quadrato

design G.T. Garattoni 2002/2019

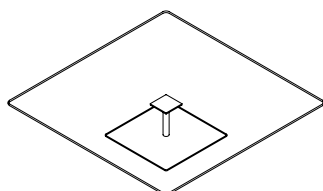

90 x 90 x h 24,5	12	0,125	30	50	1.420 □ 1.480 ■ 1.520
90 x 90 x h 40	12	0,125	30	55	1.440 □ 1.500 ■ 1.540
110 x 110 x h 24,5	12	0,184	30	59	1.530 □ 1.660 ■ 1.700
110 x 110 x h 40	12	0,184	30	64	1.550 □ 1.680 ■ 1.720

Maggiorazione basamento in finitura: **canna di fucile** 300
 Upcharge base in **gunmetal**
 Aufpreis für Gestell in **Gunmetal**
 Surcharge pour piètement en **gunmetal**

- Vetro extrachiaro / extra clear glass / extrahelles Glas / verre extra clair
 ■ Vetro fumé / smoked glass / Rauchglas / verre fumé

Farniente rettangolare

design G.T. Garattoni 2002/2019

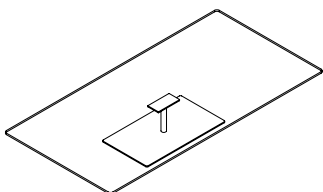

130 x 70 x h 24,5	12	0,183	30	60	1.430 □ 1.560 ■ 1.570
130 x 70 x h 40	12	0,183	30	65	1.450 □ 1.580 ■ 1.590
150 x 80 x h 24,5	12	0,185	30	61	1.520 □ 1.670 ■ 1.700
150 x 80 x h 40	12	0,185	30	66	1.540 □ 1.690 ■ 1.720

Maggiorazione basamento in finitura: **canna di fucile** 300
 Upcharge base in **gunmetal**
 Aufpreis für Gestell in **Gunmetal**
 Surcharge pour piètement en **gunmetal**

- Vetro extrachiaro / extra clear glass / extrahelles Glas / verre extra clair
 ■ Vetro fumé / smoked glass / Rauchglas / verre fumé

Farniente tondo

design G.T. Garattoni 2002/2019

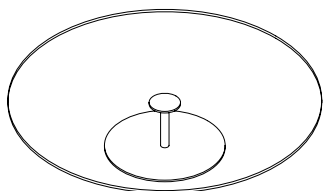

Ø 90 x h 24,5	12	0,125	30	38	1.430 □ 1.520 ■ 1.560
Ø 90 x h 40	12	0,125	30	43	1.450 □ 1.540 ■ 1.580
Ø 110 x h 24,5	12	0,184	30	47	1.530 □ 1.670 ■ 1.710
Ø 110 x h 40	12	0,184	30	52	1.550 □ 1.690 ■ 1.730
Ø 120 x h 24,5	12	0,187	30	53	1.630 □ 1.770 ■ 1.830
Ø 120 x h 40	12	0,187	30	58	1.650 □ 1.790 ■ 1.850

Maggiorazione basamento in finitura: **canna di fucile** 300
 Upcharge base in **gunmetal**
 Aufpreis für Gestell in **Gunmetal**
 Surcharge pour piètement en **gunmetal**

- Vetro extrachiaro / extra clear glass / extrahelles Glas / verre extra clair
 ■ Vetro fumé / smoked glass / Rauchglas / verre fumé

- Tavolo basso in vetro trasparente, extrachiaro o fumé con basamento in metallo in finitura cromata o canna di fucile.
- Cocktail table in transparent, extra clear or smoked glass with metal base in chrome or gunmetal.
- Couchtisch in transparentem, extrahellem Glas oder Rauchglas mit Metallgestell verchromt oder Gunmetal.
- Table basse en verre transparent, extra clair ou fumé avec piètement en métal chromé ou gunmetal.

	I E D F	dimensioni dimension abmessungen dimension	spessore thickness stärke épaisseur	volume volume volumen volume	carico ammesso admitted load tragfähigkeit charge admise	peso weight gewicht poids	prezzo price preis prix
		cm	mm	m3	kg	kg	euro

Fittipaldi 90

design G.T. Garattoni 2009

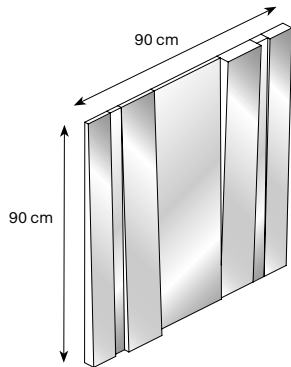

90 x 6 x h 90

4

0,1

29

A: 90 x 5 x 4

B: 90 x 10 x 4,5

C: 90 x 15 x 5,6

D: 90 x 30 x 2,5

●	860
●●	920
●●●	960
●	90
●●	95
●●●	100
●	110
●●	115
●●●	120
●	130
●●	135
●●●	140
●	200
●●	230
●●●	240

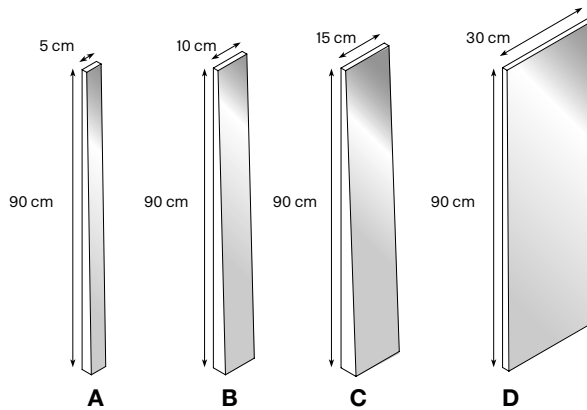

- Specchio / Mirror / Spiegel / Miroir
- Specchio fumè / Smoked mirror / Rauchglasspiegel / miroir fumé
- Specchio bronzo / Bronze mirror / Bronze Spiegel / Miroir bronze

- Specchio a parete con struttura in metallo verniciato nero opaco. Anche componibile. Disponibile in specchio, specchio fumè o bronzo.
 - Wall mirror with matt black lacquered metal structure. Also modular. Available in mirror, smoked mirror or bronze mirror.
 - Wandspiegel mit Struktur aus matt schwarz lackiertem Metall. Auch modular. Verfügbar in Spiegel, Rauchglas Spiegel oder Bronze Spiegel.
 - Miroir à mur avec structure en métal laqué noir mat. Aussi composable. Disponible en miroir, miroir fumé ou bronze.

	I E D F	dimensioni dimension abmessungen dimension	spessore thickness stärke épaisseur	volume volume volumen volume	carico ammesso admitted load tragfähigkeit charge admise	peso weight gewicht poids	prezzo price preis prix
		cm	mm	m3	kg	kg	euro

Fittipaldi 180

design G.T. Garattoni 2009

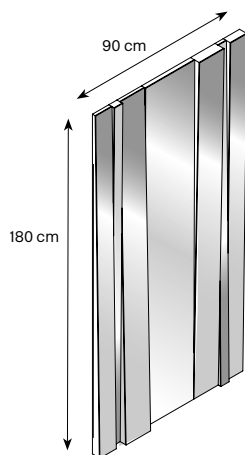

90 x 6 x h 180

4

0,2

50

A: 180 x 5 x 4

B: 180 x 10 x 4,5

C: 180 x 15 x 5,6

D: 180 x 30 x 2,5

●	1.240
●●	1.340
●●●	1.410
●	140
●●	150
●●●	160
●	180
●●	190
●●●	200
●	190
●●	200
●●●	210
●	220
●●	260
●●●	270

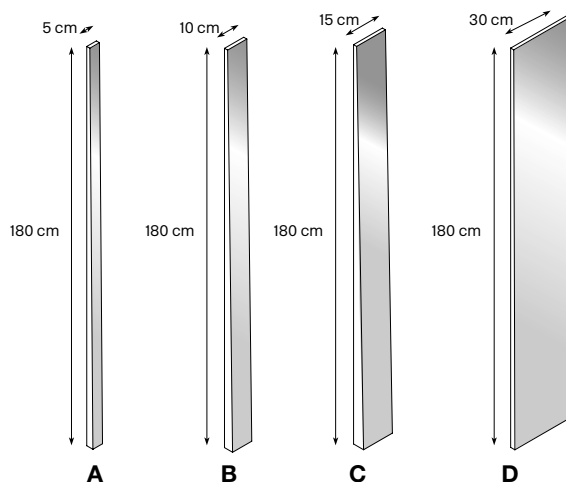

- Specchio / Mirror / Spiegel / Miroir
- Specchio fumè / Smoked mirror / Rauchglasspiegel / miroir fumé
- Specchio bronzo / Bronze mirror / Bronze Spiegel / Miroir bronze

- Specchio a parete con struttura in metallo verniciato nero opaco. Anche componibile. Disponibile in specchio, specchio fumè o bronzo.
 - Wall mirror with matt black lacquered metal structure. Also modular. Available in mirror, smoked mirror or bronze mirror.
 - Wandspiegel mit Struktur aus matt schwarz lackiertem Metall. Auch modular. Verfügbar in Spiegel, Rauchglas Spiegel oder Bronze Spiegel.
 - Miroir à mur avec structure en métal laqué noir mat. Aussi composable. Disponible en miroir, miroir fumé ou bronze.

	I E D F	dimensioni dimension abmessungen dimension	spessore thickness stärke épaisseur	volume volume volumen volume	carico ammesso admitted load tragfähigkeit charge admise	peso weight gewicht poids	prezzo price preis prix
		cm	mm	m3	kg	kg	euro

Flò 1

120 x 45 x h 52

15

0,47

70

100

1.760

□ 1.960

design Isao Hosoe 1997/2005

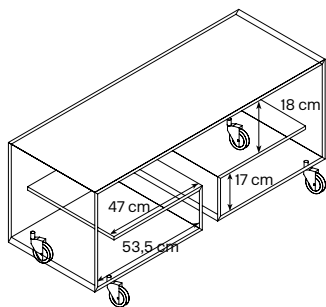

□ Vetro extrachiaro / extra clear glass / extrahelles Glas / verre extra clair

- Mobile multiuso TV su ruote
- TV stand on castors
- TV Ständer auf Rädern
- Porte TV sur roulettes

Fratina 2

design M. U.

90 x 90 x h 40

15 / 10

0,612

50

82

1.430

□ 1.580

118 x 88 x h 40

15 / 10

0,755

50

92

1.580

□ 1.740

128 x 68 x h 40

15 / 10

0,640

50

85

1.350

□ 1.490

100 x 60 x h 40

15 / 10

0,610

50

80

1.080

□ 1.200

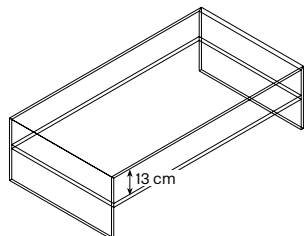

□ Vetro extrachiaro / extra clear glass / extrahelles Glas / verre extra clair

- Tavolino a ponte con ripiano, in vetro trasparente o extrachiaro. Disponibile con dimensioni a richiesta.
- Coffee table with shelf, in transparent or extra clear glass. Special sizes available.
- Couchtisch mit Ablage, in transparentem oder extrahellem Glas. Sondermaße sind möglich.
- Table à pont avec double plateau, en verre transparent ou extra clair. Dimensions spéciales sur demande.

	I E D F	dimensioni dimension abmessungen dimension	spessore thickness stärke épaisseur	volume volume volumen volume	carico ammesso admitted load tragfähigkeit charge admise	peso weight gewicht poids	prezzo price preis prix
		cm	mm	m3	kg	kg	euro

Gerundio

105 x h 200

8

0,33

70

2.410

design G.T. Garattoni 2012

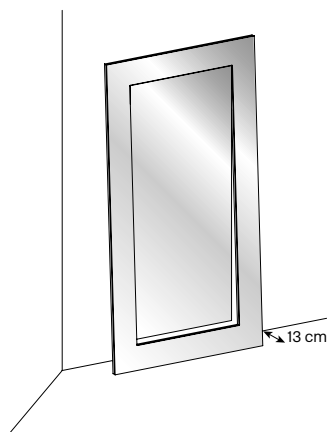

- Specchiera da parete ricavata da un'unica lastra, con cornice inclinata. Struttura in legno verniciata nero.
- Wall mirror made of an only sheet, with inclined frame. Structure in black lacquered wood.
- Wandspiegel aus einer einzigen Platte produziert, mit schrägem Rahmen. Struktur aus schwarz lackiertem Holz.
- Miroir au mur fait d'une seule plaque, avec encadrement incliné. Structure en bois laqué noir.

Gerundio

80 x h 155

8

0,25

46

1.730

design G.T. Garattoni 2012

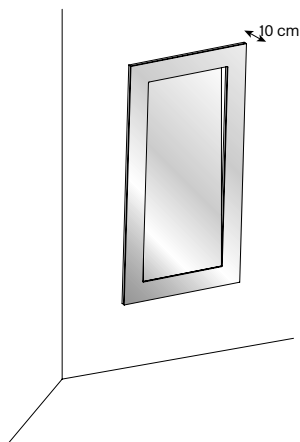

- Specchiera da parete ricavata da un'unica lastra, con cornice inclinata. Struttura in legno verniciata nero.
- Wall mirror made of an only sheet, with inclined frame. Structure in black lacquered wood.
- Wandspiegel aus einer einzigen Platte produziert, mit schrägem Rahmen. Struktur aus schwarz lackiertem Holz.
- Miroir au mur fait d'une seule plaque, avec encadrement incliné. Structure en bois laqué noir.

	I E D F	dimensioni dimension abmessungen dimension	spessore thickness stärke épaisseur	volume volume volumen volume	carico ammesso admitted load tragfähigkeit charge admise	peso weight gewicht poids	prezzo price preis prix
		cm	mm	m3	kg	kg	euro

Gerundio

155 x h 240

8

0,77

171

4.340

design G.T. Garattoni 2023

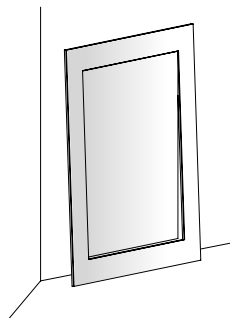

- Specchiera da parete ricavata da un'unica lastra, con cornice inclinata. Struttura in legno verniciata nero.
- Wall mirror made of an only sheet, with inclined frame. Structure in black lacquered wood.
- Wandspiegel aus einer einzigen Platte produziert, mit schrägem Rahmen. Struktur aus schwarz lackiertem Holz.
- Miroir au mur fait d'une sole plaque, avec encadrement incliné. Structure en bois laqué noir.

Gerundio

240 x h 196

8

1,01

215

4.870

design G.T. Garattoni 2023

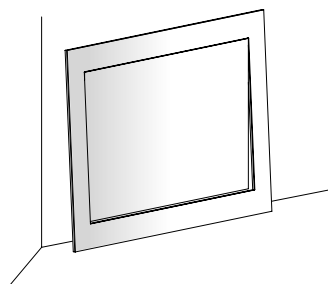

- Specchiera da parete ricavata da un'unica lastra, con cornice inclinata. Struttura in legno verniciata nero.
- Wall mirror made of an only sheet, with inclined frame. Structure in black lacquered wood.
- Wandspiegel aus einer einzigen Platte produziert, mit schrägem Rahmen. Struktur aus schwarz lackiertem Holz.
- Miroir au mur fait d'une sole plaque, avec encadrement incliné. Structure en bois laqué noir.

Gerundio

196 x h 196

8

0,81

174

3.880

design G.T. Garattoni 2023

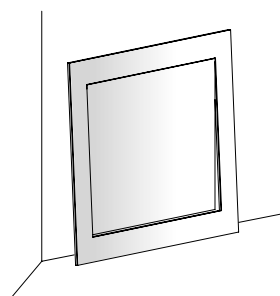

- Specchiera da parete ricavata da un'unica lastra, con cornice inclinata. Struttura in legno verniciata nero.
- Wall mirror made of an only sheet, with inclined frame. Structure in black lacquered wood.
- Wandspiegel aus einer einzigen Platte produziert, mit schrägem Rahmen. Struktur aus schwarz lackiertem Holz.
- Miroir au mur fait d'une sole plaque, avec encadrement incliné. Structure en bois laqué noir.

	I E D F	dimensioni dimension abmessungen dimension	spessore thickness stärke épaisseur	volume volume volumen volume	carico ammesso admitted load tragfähigkeit charge admise	peso weight gewicht poids	prezzo price preis prix
		cm	mm	m3	kg	kg	euro
Gerundio		105 x h 200	8	0,38		80	2.430
design G.T. Garattoni 2015							

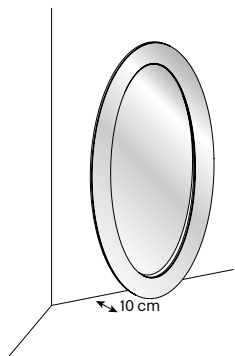

- Specchiera da parete ricavata da un'unica lastra, con cornice inclinata. Struttura in legno verniciata nero.
- Wall mirror made of an only sheet, with inclined frame. Structure in black lacquered wood.
- Wandspiegel aus einer einzigen Platte produziert, mit schrägem Rahmen. Struktur aus schwarz lackiertem Holz.
- Miroir au mur fait d'une seule plaque, avec encadrement incliné. Structure en bois laqué noir.

Gerundio		Ø 155	8	0,52		85	2.860
design G.T. Garattoni 2015							

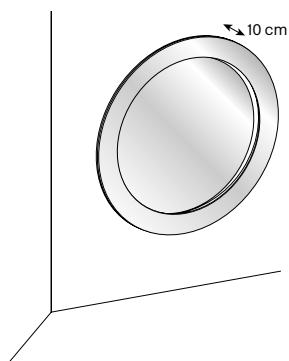

- Specchiera da parete ricavata da un'unica lastra, con cornice inclinata. Struttura in legno verniciata nero.
- Wall mirror made of an only sheet, with inclined frame. Structure in black lacquered wood.
- Wandspiegel aus einer einzigen Platte produziert, mit schrägem Rahmen. Struktur aus schwarz lackiertem Holz.
- Miroir au mur fait d'une seule plaque, avec encadrement incliné. Structure en bois laqué noir.

Gerundio		Ø 196	8	0,55		131	3.860
design G.T. Garattoni 2015							

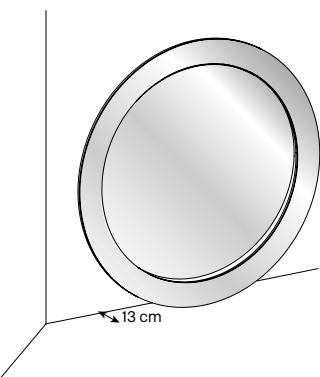

- Specchiera da parete ricavata da un'unica lastra, con cornice inclinata. Struttura in legno verniciata nero.
- Wall mirror made of an only sheet, with inclined frame. Structure in black lacquered wood.
- Wandspiegel aus einer einzigen Platte produziert, mit schrägem Rahmen. Struktur aus schwarz lackiertem Holz.
- Miroir au mur fait d'une seule plaque, avec encadrement incliné. Structure en bois laqué noir.

	I E D F	dimensioni dimension abmessungen dimension	spessore thickness stärke épaisseur	volume volume volumen volume	carico ammesso admitted load tragfähigkeit charge admise	peso weight gewicht poids	prezzo price preis prix
		cm	mm	m3	kg	kg	euro

Gotham

design Leonardi_Marinelli 2015

130 x 65 x h 33

12

0,48

50

93

1.680

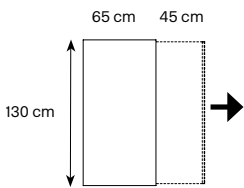
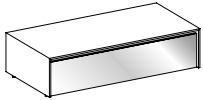

Optional: Caricabatteria wireless. / Optional: wireless battery charger.
Optional: wireless charger. / Option: chargeur wireless.

290

- Tavolo basso rettangolare in vetro fume' con 1 cassetto nero in legno con chiusura soft e frontale a specchio fumé.
Optional: Caricabatteria wireless.
- Low rectangular table in smoked glass with 1 black wooden drawer with soft closure and frontal smoked mirror.
Optional: wireless battery charger.
- Niedriger rechteckiger Tisch aus Rauchglas mit 1 schwarzen Holzladen mit Soft Sperrung und frontalem Rauchglas Spiegel.
Optional: wireless charger.
- Table bas rectangulaire en verre fumé avec 1 tiroir en bois noir avec fermeture soft et frontal en miroir fumé.
Option: chargeur wireless.

Gotham

design Leonardi_Marinelli 2015

150 x 85 x h 33

12

0,63

50

126

1.940

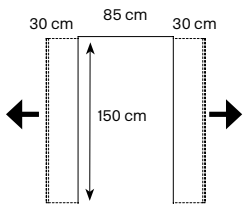
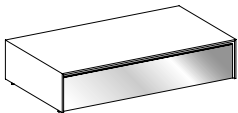

Optional: Caricabatteria wireless. / Optional: wireless battery charger.
Optional: wireless charger. / Option: chargeur wireless.

290

- Tavolo basso rettangolare in vetro fume' con 2 cassetti neri in legno con chiusura soft e frontale a specchio fumé.
Optional: Caricabatteria wireless.
- Low rectangular table in smoked glass with 2 black wooden drawers with soft closure and frontal smoked mirror.
Optional: wireless battery charger.
- Niedriger rechteckiger Tisch aus Rauchglas mit 2 schwarzen Holzladen mit Soft Sperrung und frontalem Rauchglas Spiegel.
Optional: wireless charger.
- Table bas rectangulaire en verre fumé avec 2 tiroirs en bois noir avec fermeture soft et frontal en miroir fumé.
Option: chargeur wireless.

Gotham

design Leonardi_Marinelli 2015

120 x 120 x h 33

12

0,77

50

141

2.280

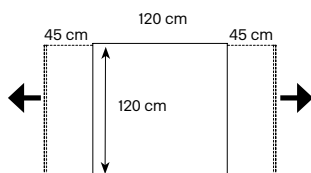
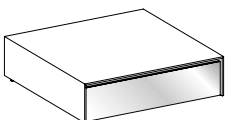

Optional: Caricabatteria wireless. / Optional: wireless battery charger.
Optional: wireless charger. / Option: chargeur wireless.

290

- Tavolo basso quadrato in vetro fume' con 2 cassetti neri in legno con chiusura soft e frontale a specchio fumé.
Optional: Caricabatteria wireless.
- Low square table in smoked glass with 2 black wooden drawers with soft closure and frontal smoked mirror.
Optional: wireless battery charger.
- Niedriger quadratischer Tisch aus Rauchglas mit 2 schwarzen Holzladen mit Soft Sperrung und frontalem Rauchglas Spiegel.
Optional: wireless charger.
- Table bas carré en verre fumé avec 2 tiroirs en bois noir avec fermeture soft et frontal en miroir fumé.
Option: chargeur wireless.

	I E D F	dimensioni dimension abmessungen dimension	spessore thickness stärke épaisseur	volume volume volumen volume	carico ammesso admitted load tragfähigkeit charge admise	peso weight gewicht poids	prezzo price preis prix
		cm	mm	m3	kg	kg	euro

Gotham consolle

120 x 45 x h 80

12

0,65

50

74

1.580

design Leonardi_Marinelli 2015

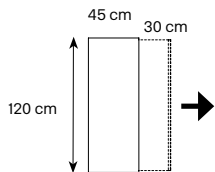
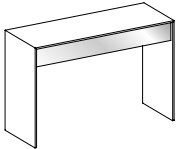

Optional: Caricabatteria wireless. / Optional: wireless battery charger.
Optional: wireless charger. / Option: chargeur wireless.

290

- Consolle / Scrivania in vetro' fume' con cassetto nero in legno con chiusura soft e frontale a specchio fumé.
Optional: Caricabatteria wireless.
- Console/desk in smoked glass with black wooden drawer with soft closure and frontal smoked mirror.
Optional: wireless battery charger.
- Konsole / Schreibtisch aus Rauchglas mit schwarzem Holzladen mit Soft Sperrung und frontalem Rauchglas Spiegel.
Optional: wireless charger.
- Console / bureau en verre fumé avec tiroir en bois noir avec fermeture soft et frontal en miroir fumé.
Option: chargeur wireless.

Gotham side table

50 x 50 x h 55

12

0,23

50

58

1.260

design Leonardi_Marinelli 2015

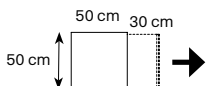
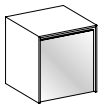

Optional: Caricabatteria wireless. / Optional: wireless battery charger.
Optional: wireless charger. / Option: chargeur wireless.

290

- Fianco divano o comodino in vetro' fume' con 1 cassetto nero in legno con chiusura soft e frontale a specchio fumé.
Optional: Caricabatteria wireless.
- End table or bed side table in smoked glass with 1 black wooden drawer with soft closure and frontal smoked mirror.
Optional: wireless battery charger
- Abstelltisch oder Nachttisch mit 1 schwarzen Holzladen mit Soft Sperrung und frontalem Rauchglas Spiegel.
Optional: wireless charger.
- Petite table ou chevet avec 1 tiroir en bois noir avec fermeture soft et frontal en miroir fumé.
Option : chargeur wireless.

	I E D F	dimensioni dimension abmessungen dimension	spessore thickness stärke épaisseur	volume volume volumen volume	carico ammesso admitted load tragfähigkeit charge admise	peso weight gewicht poids	prezzo price preis prix
		cm	mm	m3	kg	kg	euro

Grattacielo componibile

design Marco Gaudenzi,
Isao Hosoe, 1991/1993

58 x 45 x h 13	12	0,040		10	290
					<input type="checkbox"/> 320

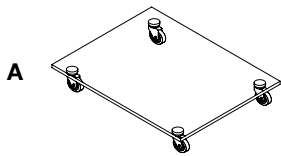

A

- Elemento: Base con ruote
- Component: Base Unit with castors
- Element: Grundelement mit Rollen
- Élément: Base avec roulettes

58 x 45 x h 13,5	12 / 15	0,040		11	300
					<input type="checkbox"/> 330

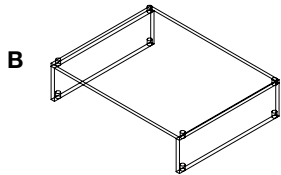

B

- Elemento: Intermedio semplice
- Component: Intermediate Unit
- Element: Einfaches Mittelelement
- Élément: Intermédiaire simple

58 x 45 x h 13,5	12 / 15	0,040		11	280
					<input type="checkbox"/> 310

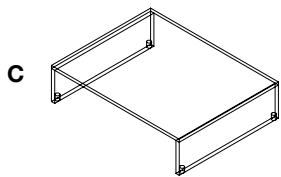

C

- Elemento: Terminale semplice
- Component: Top Unit
- Element: Einfaches Endelement
- Élément: Terminal simple

58 x 45 x h 25,5	12 / 15	0,080		20	340
					<input type="checkbox"/> 390

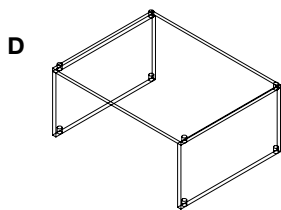

D

- Elemento: Intermedio doppio
- Component: Double Intermediate Unit
- Element: Doppeltes Mittelelement
- Élément: Intermédiaire double

58 x 45 x h 25,5	12 / 15	0,080		16	330
					<input type="checkbox"/> 380

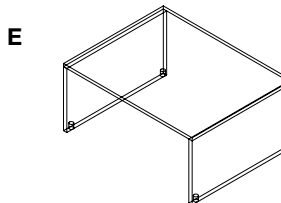

E

- Elemento: Terminale doppio
- Component: Double Top Unit
- Element: Doppeltes Endelement
- Élément: Terminal double

Vetro extrachiaro / extra clear glass / extrahelles Glas / verre extra clair

- Elementi in vetro float 12 / 15 mm sovrapponibili, con perni di acciaio, su base munita di ruote gommate.
- 12 / 15 mm float glass elements, superposition on a base, equipped with rubber castors.
- Elemente aus 12 / 15 mm Glass float aufstapelbar auf Basis mit gummierten Rädern,
- Éléments en verre «float» 12 / 15 mm, superposable sur base avec roulettes en caoutchouc.

Grattacielo componibile

design Marco Gaudenzi,
Isao Hosoe, 1991/1993

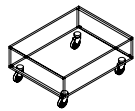

A + C
COMP. 1 h 26
euro 570 □ 630

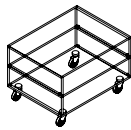

A + B + C
COMP. 2 h 40
euro 870 □ 960

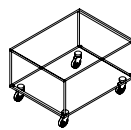

A + E
COMP. 3 h 39
euro 630 □ 700

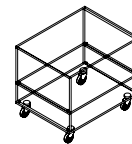

A + B + E
COMP. 4 h 52
euro 920 □ 1.030

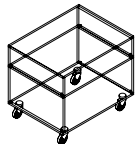

A + D + C
COMP. 5 h 52
euro 910 □ 1.020



A + 2B + C
COMP. 6 h 54
euro 1.170 □ 1.290

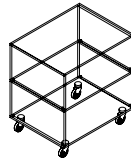

A + D + E
COMP. 7 h 64
euro 960 □ 1.090

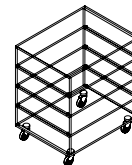

A + 3B + C
COMP. 8 h 67
euro 1.470 □ 1.620



A + 2B + E
COMP. 9 h 66
euro 1.220 □ 1.360

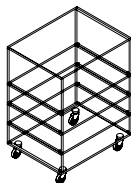

A + 3B + E
COMP. 10 h 79
euro 1.520 □ 1.690

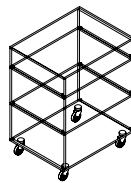

A + 2D + C
COMP. 11 h 78
euro 1.250 □ 1.410

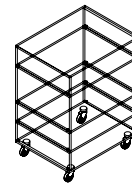

A + 2B + D + C
COMP. 12 h 79
euro 1.510 □ 1.680



A + 4B + C
COMP. 13 h 81
euro 1.770 □ 1.950

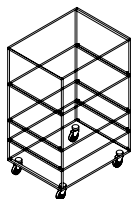

A + 2B + D + E
COMP. 14 h 91
euro 1.560 □ 1.750

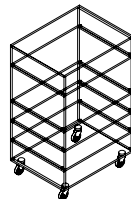

A + 3B + D + C
COMP. 15 h 93
euro 1.810 □ 2.010

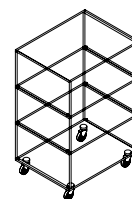

A + 2D + E
COMP. 16 h 90
euro 1.300 □ 1.480

□ Vetro extrachiaro / extra clear glass / extrahelles Glas / Verre extra clair

Grattacielo Componibile / stackable Grattacielo / Stapelbare Grattacielo / Grattacielo componibile

Cassetti 58 / Drawer 58 / Schublade 58 / Tiroir 58

U

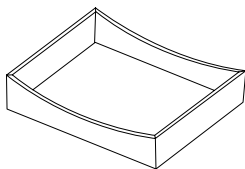

U 54,5 x 44,5 x h 12

wengè	0,068	5	300
rovere sbiancato bleached oak gebleichtes Eichenolz rouvre blanchi	0,068	5	290
noce canaletto canaletto walnut Walnuß canaletto noyer canaletto	0,068	5	320
RAL	0,068	5	295

H

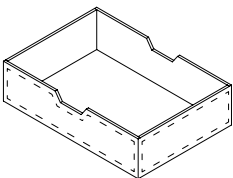

H 54,5 x 44,5 x h 12

Cassetto cuoio naturale o nero Natural or black leather drawer Schublade in Leder natur oder schwarz Tiroir en cuir naturel ou noir	0,068	5	540
--	-------	---	-----

	I E D F	dimensioni dimension abmessungen dimension	spessore thickness stärke épaisseur	volume volume volumen volume	carico ammesso admitted load tragfähigkeit charge admise	peso weight gewicht poids	prezzo price preis prix
		cm	mm	m3	kg	kg	euro

Grattacielo Fix 58/80

design Marco Gaudenzi,
Isao Hosoe, 1991/1993

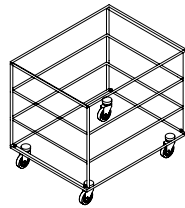

Comp. fix 6/a
58 x 45 x h 52
euro 990 □ 1.160

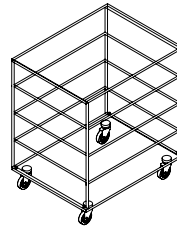

Comp. fix 8/a
58 x 45 x h 66
euro 1.180 □ 1.380

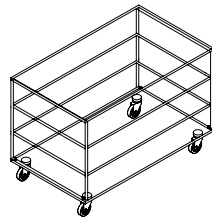

Comp. fix 6/d
80 x 45 x h 52
euro 1.090 □ 1.280

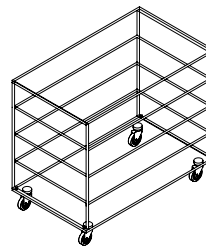

Comp. fix 8/d
80 x 45 x h 66
euro 1.300 □ 1.520

□ Vetro extrachiaro / extra clear glass / extrahelles Glas / verre extra clair
- Fisso non componibile / Fixed System / Fixiertes system / Systeme non superposable

- Carrello multiuso a struttura fissa su ruote.
- Fixed trolley-system on castors.
- Mehrwertiger wagen mit fixierte Struktur auf Rollen.
- Meuble à multiples emplois avec structure fixe sur roulettes.

Cassetti 58 / Drawer 58 / Schublade 58 / Tiroir 58

U

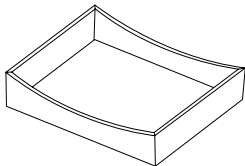

U 54,5 x 44,5 x h 12

wengè	0,068	5	300
rovere sbiancato bleached oak gebleichtes Eichenolz rouvre blanchi	0,068	5	290
noce canaletto canaletto walnut Walnuß canaletto noyer canaletto	0,068	5	320
RAL	0,068	5	295

H

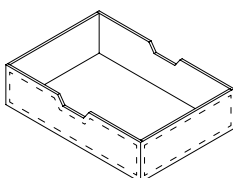

H 54,5 x 44,5 x h 12

Cassetto cuoio naturale o nero Natural or black leather drawer Schublade in Leder natur oder schwarz Tiroir en cuir naturel ou noir	0,068	5	540
--	-------	---	-----

	I E D F	dimensioni dimension abmessungen dimension	spessore thickness stärke épaisseur	volume volume volumen volume	carico ammesso admitted load tragfähigkeit charge admise	peso weight gewicht poids	prezzo price preis prix
		cm	mm	m3	kg	kg	euro

Gulliver

design M. U.

115 x 45 x h 70	15	0,638	40	56	1.100
140 x 45 x h 70	15	0,749	40	63	1.160
					1.270

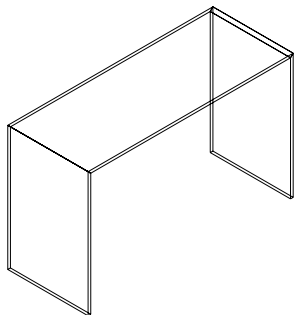

Vetro extrachiario / extra clear glass / extrahelles Glas / verre extra clair

Gulliver 2

design M. U.

115 x 45 x h 80	15 / 10	0,638	40	56	1.340
					1.480

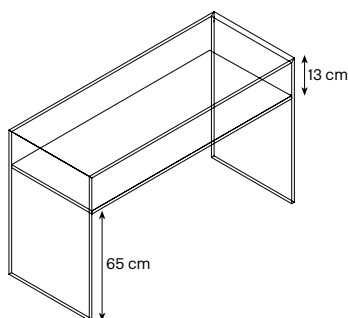

Vetro extrachiario / extra clear glass / extrahelles Glas / verre extra clair

- Consolle / scrivania in vetro trasparente o extrachiario. Disponibile con dimensioni a richiesta.
- Console / desk in transparent or extra clear glass. Special sizes available.
- Konsole oder Schreibtisch aus transparentem oder extrahellem Glas. Sondermaß sind möglich.
- Consolle ou bureau en verre transparent ou extra clair. Dimensions spéciales sur demande.

Cassetti / Drawer / Schublade / Tiroir

U

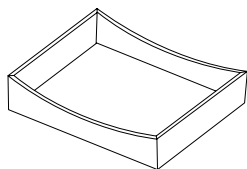

U 54,5 x 44,5 x h 12

wengè	0,068	5	300
rovere sbiancato bleached oak gebleichtes Eichenolz rouvre blanchi	0,068	5	290
noce canaletto canaletto walnut Walnuß canaletto noyer canaletto	0,068	5	320
RAL	0,068	5	295

H

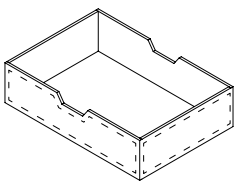

H 54,5 x 44,5 x h 12

Cassetto cuoio naturale o nero Natural or black leather drawer Schublade in Leder natur oder schwarz Tiroir en cuir naturel ou noir	0,068	5	540
--	-------	---	-----

Modularità e dimensioni versione a parete / Modularity and dimensions wall version
 Modularität und Abmessungen Wandversion/ Modularité et dimensions version au mur

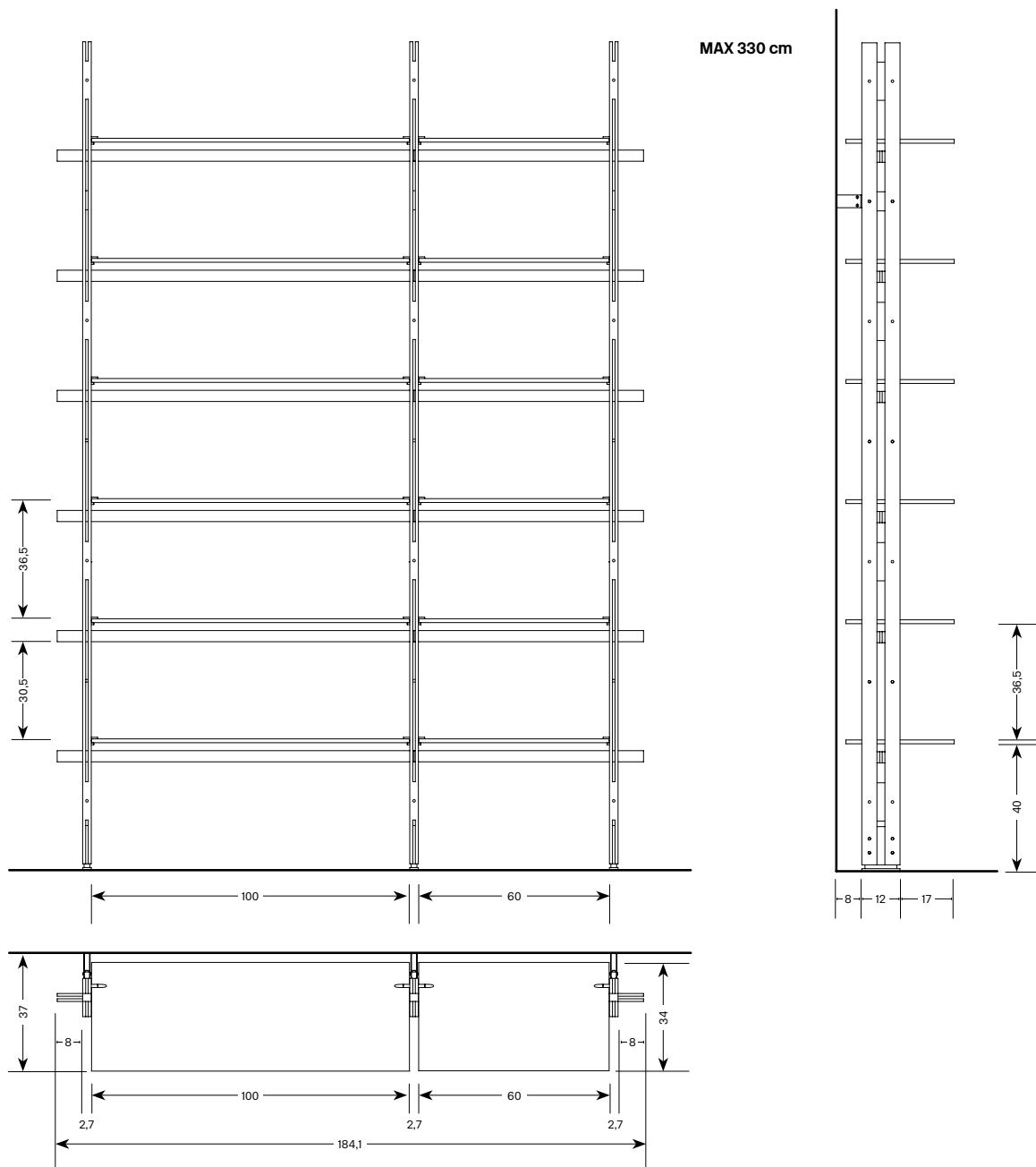

- Per il calcolo della lunghezza totale della libreria, sommare i moduli scelti (60 o 100 cm), più un montante tra un modulo e l'altro (2,7 cm), più due montanti esterni (2,7 cm cadauno), più 2 terminali esterni (8 cm cadauno).
- To calculate total length of the bookcase, add the chosen modules (60 or 100 cm), plus one upright between the modules (2,7 cm) and 2 external uprights (2,7 cm each), plus 2 external terminals (8 cm each).
- Für die Berechnung der Gesamtlänge des Bücherregal, die ausgewählten Module (60 oder 100 cm), mit einem Pfosten zwischen den Modulen (2,7 cm) plus 2 Endpfosten (je 2,7 cm) plus 2 Terminalteile (je 8 cm) addieren.
- Pour calculer la longueur totale de la bibliothèque, additionner les modules choisis (60 ou 100 cm), avec un montant entre les modules (2,7 cm) e 2 montants extérieurs (2,7 cm chaque) et 2 éléments terminals (8 cm chaque).

- I tasselli di fissaggio in dotazione possono dimostrarsi inadatti in alcune situazioni. La qualità dell'operazione di montaggio è di esclusiva responsabilità del cliente che dovrà utilizzare i materiali di fissaggio più idonei alle caratteristiche strutturali del soffitto, della parete e del pavimento.
- The screw anchors that are included might appear unsuitable in certain situations. The quality of the assembly is under complete responsibility of the client, who will have to use the fixing materials best suited for the structural characteristics of the ceiling, wall and floor.
- Die gelieferten Befestigungsdübel können in bestimmten Situationen als ungeeignet erscheinen. Die Qualität der Montage ist exklusive Verantwortung des Kunden, der für die strukturellen Eigenschaften von Decke, Wand und Boden, die am besten geeigneten Befestigungsmaterialien benutzen muss.
- Les chevilles de fixation fournies peuvent résulter inapproprié dans certaines situations. La qualité de l'opération de montage est responsabilité exclusive du client, qui devra utiliser les matériaux de fixations les plus indiqués aux attributs du plafond, du mur et du sol.

Modularità e dimensioni versione a soffitto / Modularity and dimensions ceiling version
 Modularität und Abmessungen Deckenversion / Modularité et dimensions version au plafond

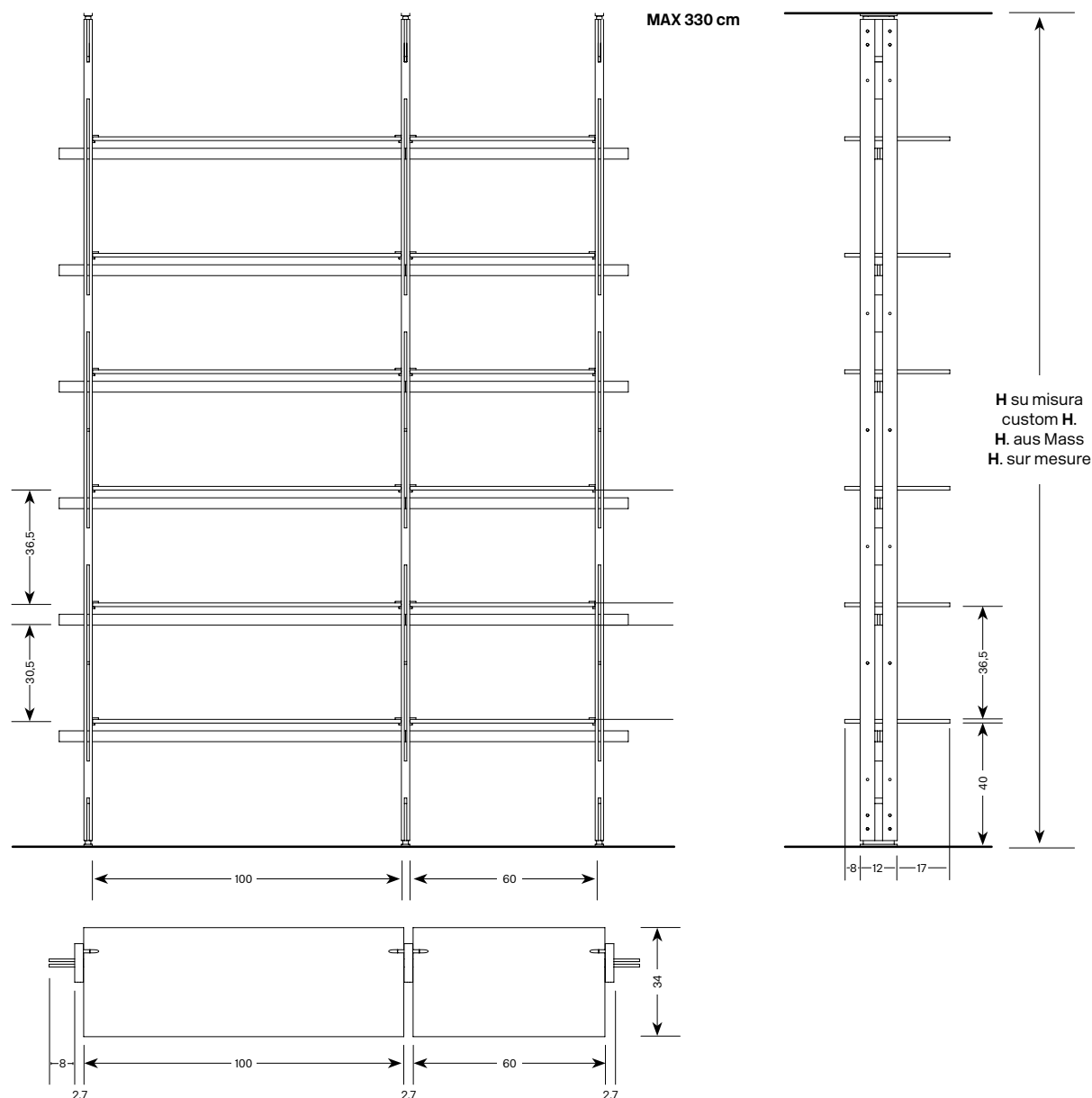

- Per il calcolo della lunghezza totale della libreria, sommare i moduli scelti (60 o 100 cm), più un montante tra un modulo e l'altro (2,7 cm), più due montanti esterni (2,7 cm cadauno), più 2 terminali esterni (8 cm cadauno).
- To calculate total length of the bookcase, add the chosen modules (60 or 100 cm), plus one upright between the modules (2,7 cm) and 2 external uprights (2,7 cm each), plus 2 external terminals (8 cm each).
- Für die Berechnung der Gesamtlänge des Bücherregal, die ausgewählten Module (60 oder 100 cm), mit einem Pfosten zwischen den Modulen (2,7 cm) plus 2 Endpfosten (je 2,7 cm) plus 2 Terminalteile (je 8 cm) addieren.
- Pour calculer la longueur totale de la bibliothèque, additionner les modules choisis (60 ou 100 cm), avec un montant entre les modules (2,7 cm) e 2 montants extérieurs (2,7 cm chaque) et 2 éléments terminals (8 cm chaque).

- I tasselli di fissaggio in dotazione possono dimostrarsi inappropriati in alcune situazioni. La qualità dell'operazione di montaggio è di esclusiva responsabilità del cliente che dovrà utilizzare i materiali di fissaggio più idonei alle caratteristiche strutturali del soffitto, della parete e del pavimento.
- The screw anchors that are included might appear unsuitable in certain situations. The quality of the assembly is under complete responsibility of the client, who will have to use the fixing materials best suited for the structural characteristics of the ceiling, wall and floor.
- Die gelieferten Befestigungsdübel können in bestimmten Situationen als ungeeignet erscheinen. Die Qualität der Montage ist exklusive Verantwortung des Kunden, der für die strukturellen Eigenschaften von Decke, Wand und Boden, die am besten geeigneten Befestigungsmaterialien benutzen muss.
- Les chevilles de fixation fournies peuvent résulter inapproprié dans certaines situations. La qualité de l'opération de montage est responsabilité exclusive du client, qui devra utiliser les matériaux de fixations les plus indiqués aux attributs du plafond, du mur et du sol.

Specifiche tecniche accessori / accessories' technical specifications
 Technische Angaben der Zubehöre / Spécifications techniques des accessoires

CONTENITORI ORIZZONTALI / HORIZONTAL STORAGE UNITS / HORIZONTALE ELEMENTE / RECIPIENTS HORIZONTEAUX

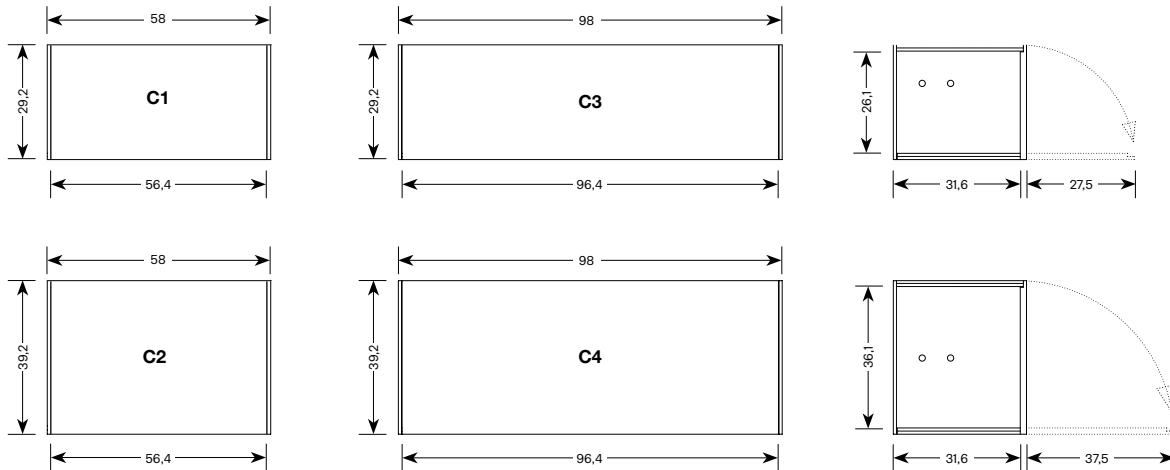

CONTENITORI VERTICALI / VERTICAL STORAGE UNITS / SENKRECHTE ELEMENTE / RECIPIENTS VERTICALES

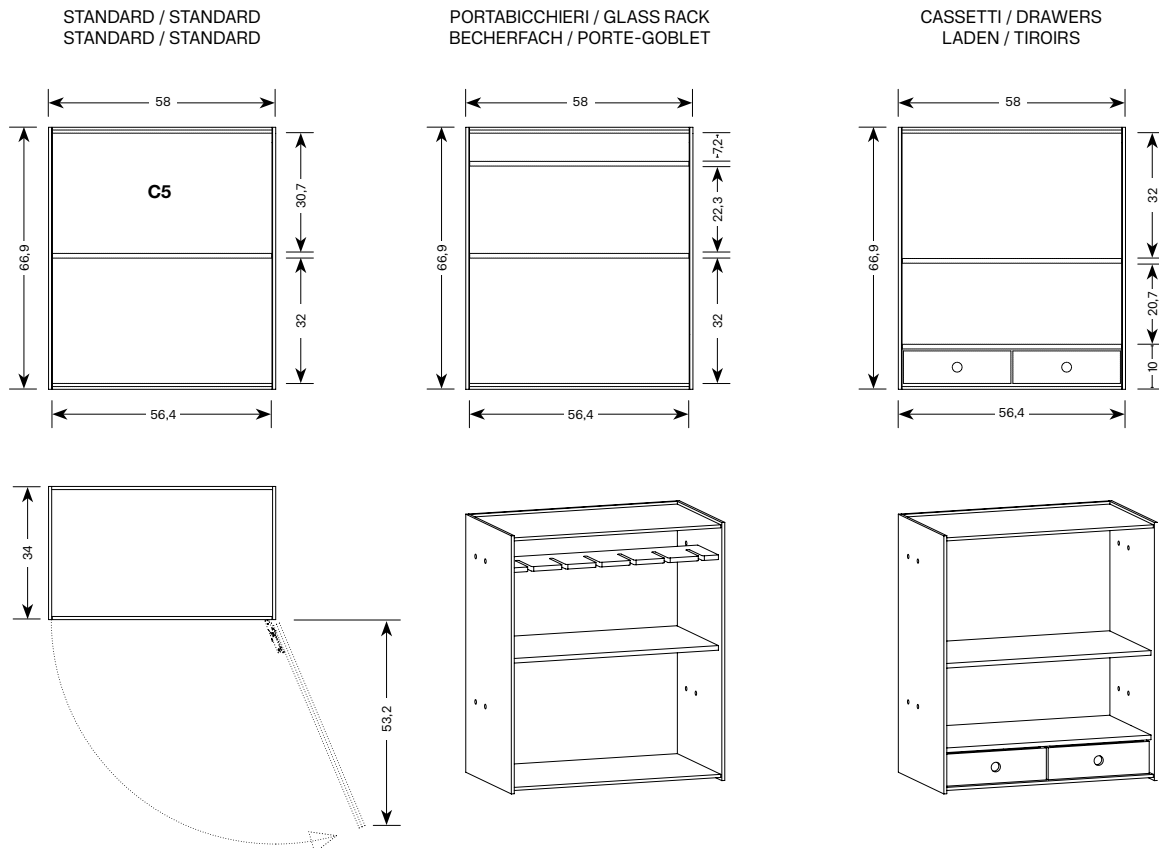

Specifiche tecniche accessori / accessories' technical specifications
 Technische Angaben der Zubehöre / Spécifications techniques des accessoires

MODULO TV / TV MODULE / TV MODUL / MODULE TV

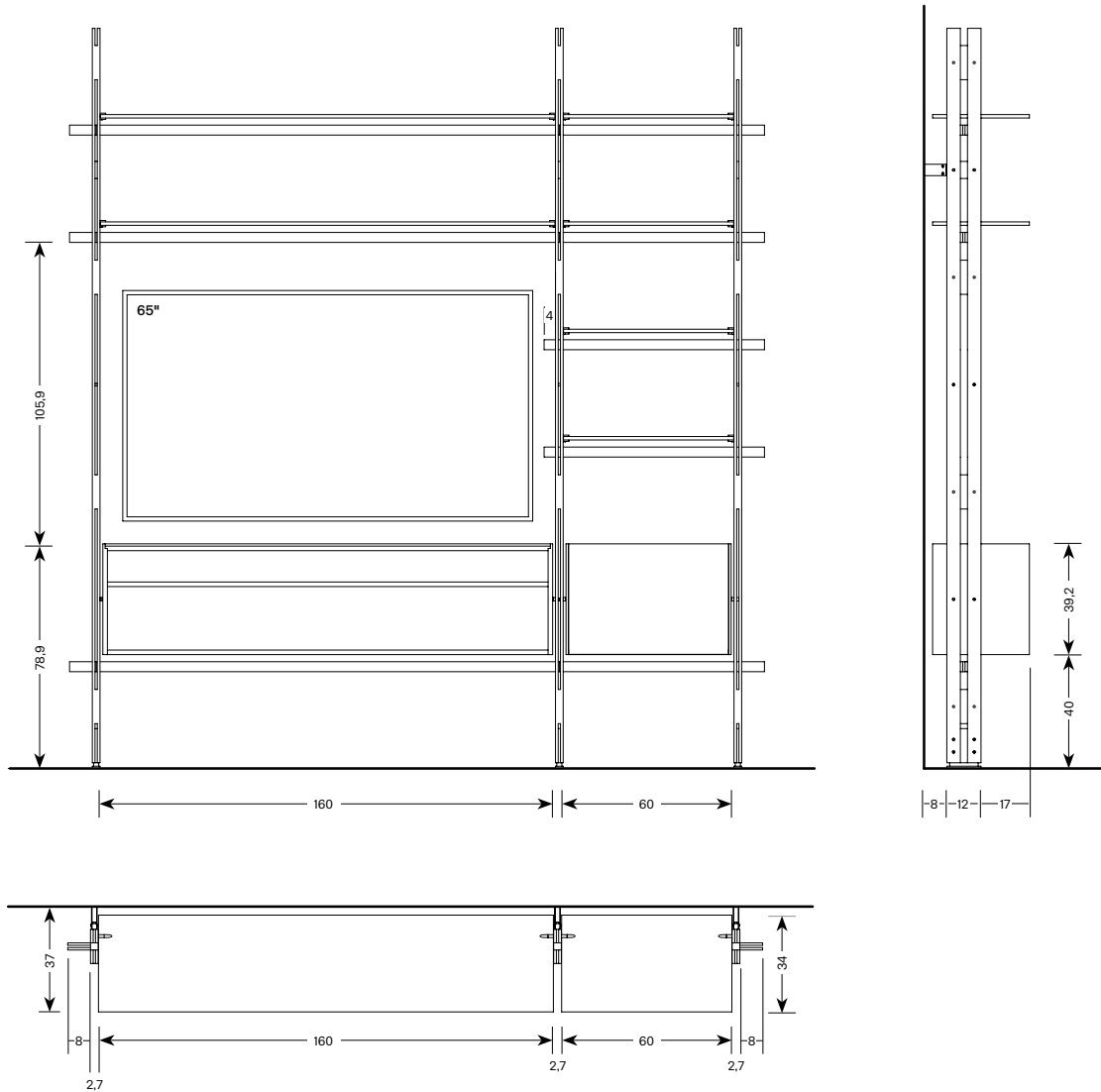

CONTENITORE ORIZZONTALE MODULO TV / HORIZONTAL TV STORAGE UNIT HORIZONTALES TV ELEMENT / RECIPIENT HORIZONTAL MODULE TV

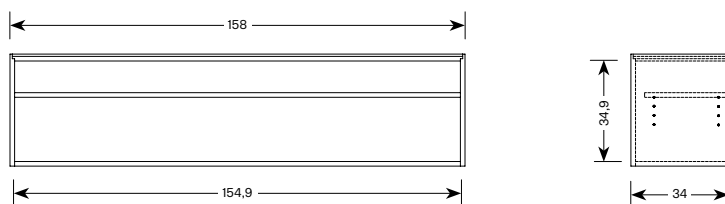

	I E D F	dimensioni dimension abmessungen dimension	spessore thickness stärke épaisseur	volume volume volumen volume	carico ammesso admitted load tragfähigkeit charge admise	peso weight gewicht poids	prezzo price preis prix
		cm	mm	m3	kg	kg	euro

Hemingway

design Massimo Castagna 2020

Versione a parete
Wall version
Wandversion
Version au mur

MONTANTI / UPRIGHTS
PFOSTEN / MONTANTS

M2	12 x 2,7 x h 260		0,043		12	1.390
----	------------------	--	-------	--	----	-------

Può accogliere al massimo nr. 6 ripiani / can accomodate maximum 6 shelves
kann maximal 6 Böden aufnehmen / peut acceullir maximum 6 étagères

M1	12 x 2,7 x h 300		0,049		14	1.520
----	------------------	--	-------	--	----	-------

Può accogliere al massimo nr. 7 ripiani / can accomodate maximum 7 shelves
kann maximal 7 Böden aufnehmen / peut acceullir maximum 7 étagères

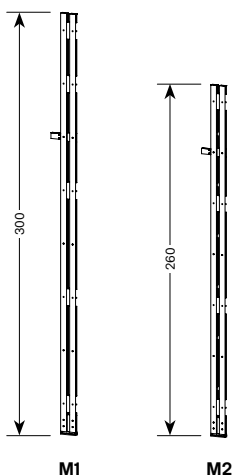

Specificare la finitura in legno del montante SIBERIAN ASH oppure EUCALIPTO
Specify wood finish of upright SIBERIAN ASH or EUCALIPTO
Holzausführung der Pfosten angeben SIBERIAN ASH oder EUCALIPTO
Indiquer finition bois du montant SIBERIAN ASH ou EUCALIPTO

Specificare la finitura in metallo degli inserti CROMO LUCIDO oppure ORO LUCIDO
Specify metal finish of inserts POLISHED CHROME or POLISHED GOLD finish
Metallausführung der Einsätze angeben CHROM GLÄNZEND oder GOLD GLÄNZEND
Indiquer finition inserts en métal CHROME BRILLANT ou OR BRILLANT

Staffa di fissaggio a parete e piede regolabile sempre inclusi nel montante
Wall fixing bracket and adjustable foot always included in the upright
Pfosten immer inklusiver Wandhalterung und regulierbarem Fuß
Support de fixation au mur et pied réglable toujours inclus avec le montant

Montanti disponibili su misura da un'altezza minima di cm 137 ad una massima di cm 330. Per i prezzi vedere tabella.
Per composizioni di altezza non compresa fra queste misure, richiedere fattibilità e preventivo al ns. ufficio vendite

Uprights available in custom size from minimum 137cm to maximum 330cm. For pricing see schedule.
For compositions of heights not included in these measures, ask our sales department for feasibility and pricing.

Pfosten auf Maß verfügbar von mindestens 137cm bis maximal 330cm. Siehe Tabelle für die Preise. Für Kompositionen in Höhe die nicht in diesen Maßen aufgeführt sind, wenden Sie sich bitte an unser Verkaufsbüro um Machbarkeit und Preise anzufragen.

Montants disponibles sur mesure de minimum 137cm à maximum 330cm. Pour les prix voir tableau.
Pour compositions d'hauteur pas inclus dans ces mesures, demander faisabilité et prix à notre bureau de ventes.

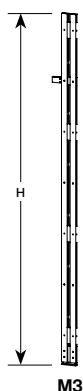

H / M3	nr. max di ripiani maximum number of shelves maximale Bödennummer numéro maximum d'étagères	euro
cm 137 - 174	3	1.460
cm 175 - 212	4	1.530
cm 213 - 250	5	1.590
cm 251 - 288	6	1.660
cm 289 - 330	7	1.740

- Libreria modulare con fissaggio a parete. Montanti verticali e traversi orizzontali in legno massello finitura Siberian Ash o Eucalipto, con inserti metallo cromo lucido o oro lucido.
Ripiani in vetro extrachiaro o fumè. Piedi regolabili in altezza +2 cm.
Attrezzabile con contenitori di diverse dimensioni e utilizzi, oppure scrittoio home office.
- Modular bookcase with wall fixing. Vertical uprights and horizontal beams in solid wood Siberian Ash or Eucalipto finish, with inserts in metal polished chrome or polished gold.
Shelves in extra clear or smoked glass. Feet adjustable in height +2 cm.
Can be fitted with storage units of different dimensions and usage, or home office desk.
- Modulares Bücherregal mit Wandbefestigung. Senkrechte Pfosten und waagrechte Balken aus Massivholz Siberian Ash oder Eucalipto, mit Metalleinsätze in Chrom glänzend oder Gold glänzend.
Böden aus extrahellem Glas oder Rauchglas. Höhenregulierbare Füße +2 cm.
Kann mit Schränkchen aus verschiedenen Maßen und Gebrauch ausgestattet werden, oder mit Home Office.
- Bibliothèque modulaire avec fixation au mur. Montants verticales et travers horizontal en bois massif Siberian Ash ou Eucalipto, avec inserts en métal chrome brillant et or brillant.
Étagères en verre extra clair ou fumé. Pieds réglables en hauteur + 2 cm.
Peut être équipé avec des récipient en mesure et usage différent, ou avec bureau.

I	dimensioni	spessore	volume	carico ammesso	peso	prezzo
E	dimension	thickness	volume	admitted load	weight	price
D	abmessungen	stärke	volumen	tragfähigkeit	gewicht	preis
F	dimension	épaisseur	volume	charge admise	poids	prix
	cm	mm	m3	kg	kg	euro

Hemingway

design Massimo Castagna 2020

Versione a soffitto
Ceiling mounted version
Version mit Deckenbefestigung
Version au plafond

MONTANTI / UPRIGHTS
PFOSTEN / MONTANTS

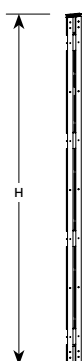

M4

La libreria, con fissaggio a soffitto, viene sempre fornita con montanti su misura, da un'altezza minima di cm 222 ad una massima di cm 330. Per i prezzi vedere tabella. Per composizioni di altezza non compresa fra queste misure, richiedere fattibilità e preventivo al ns. ufficio vendite.

The bookcase with ceiling fixing is always supplied with custom uprights, from a minimum of 222 cm height to maximum 330 cm. For pricing see schedule. For compositions of heights not included in these measures, ask our sales department for feasibility and pricing.

Das Bücherregal mit Deckenbefestigung wird immer mit Pfosten auf Maß geliefert, von einer Höhe von mindestens 222 cm bis maximal 330 cm. Siehe Tabelle für Preise. Für Kompositionen in Höhe die nicht in diesen Maßen aufgeführt sind, wenden Sie sich bitte an unser Verkaufsbüro um Machbarkeit und Preise anzufragen.

La bibliothèque avec fixation au plafond est toujours fournie avec montants sur mesure, d'une hauteur de minimum 222 cm à maximum 330 cm. Pour les prix voir tableau. Pour compositions d'hauteur pas inclus dans ces mesures, demander faisabilité et prix à notre bureau de ventes.

H / M4	nr. max di ripiani maximum number of shelves maximale Bödennummer numéro maximum d'étagères	euro
cm 222 - 259	5	1.750
cm 260 - 297	6	1.820
cm 298 - 330	7	1.900

Comunicare al momento dell'ordine l'altezza utile del soffitto.

Consigliamo di rilevare l'altezza del soffitto in più punti.

When ordering specify height to ceiling.

We recommend to measure the ceiling height in different places.

Bei Bestellung die Deckenhöhe angeben.

Wir empfehlen die Deckenhöhe in verschiedenen Punkten abzumessen.

A la commande indiquer hauteur sous le plafond.

Nous conseillons de mesurer l'hauteur sous le plafond en différents points.

Specificare la finitura in legno del montante SIBERIAN ASH oppure EUCALIPTO

Specify wood finish of upright SIBERIAN ASH or EUCALIPTO

Holzausführung der Pfosten angeben SIBERIAN ASH oder EUCALIPTO

Indiquer finition bois du montant SIBERIAN ASH ou EUCALIPTO

Specificare la finitura in metallo degli inserti CROMO LUCIDO oppure ORO LUCIDO

Specify metal finish of inserts POLISHED CHROME or POLISHED GOLD finish

Metallausführung der Einsätze angeben CHROM GLÄNZEND oder GOLD GLÄNZEND

Indiquer finition inserts en métal CHROME BRILLANT ou OR BRILLANT

Staffa di fissaggio a soffitto regolabile +3cm e piede regolabile +2cm sempre inclusi nel montante

Adjustable ceiling fixing bracket +3cm and adjustable foot +2cm always included in the upright

Pfosten immer inklusiver regulierbarer Deckenhalterung +3cm und regulierbarem Fuß +2cm

Support de fixation au plafond réglable +3cm et pied réglable +2cm toujours inclus avec le montant

- Libreria modulare con fissaggio a soffitto. Montanti verticali e traversi orizzontali in legno massello finitura Siberian Ash o Eucalipto, con inserti metallo cromo lucido o oro lucido. Ripiani in vetro extrachiaro o fumé. Attrezzabile con contenitori di diverse dimensioni e utilizzi, oppure scrittoio home office.
- Modular bookcase with ceiling fixing. Vertical uprights and horizontal beams in solid wood, Siberian Ash or Eucalipto finish, with inserts in metal polished chrome or polished gold. Shelves in extra clear or smoked glass. Can be fitted with storage units of different dimensions and usage, or home office desk.
- Moduliert Bücherregal mit Deckenbefestigung. Senkrechte Pfosten und waagrechte Balken aus Massivholz Siberian Ash oder Eucalipto, mit Metalleinsätze in Chrom glänzend oder Gold glänzend. Böden aus extrahellem Glas oder Rauchglas. Kann mit Schränkchen aus verschiedenen Maßen und Gebrauch ausgestattet werden, oder mit Home Office.
- Bibliothèque modulaire avec fixation au plafond. Montants verticaux et travers horizontal en bois massif Siberian Ash ou Eucalipto, avec inserts en métal chrome brillant et or brillant. Étagères en verre extra clair ou fumé. Peut être équipé avec des récipient en mesure et usage différent, ou avec bureau.

	I E D F	dimensioni dimension abmessungen dimension	spessore thickness stärke épaisseur	volume volume volumen volume	carico ammesso admitted load tragfähigkeit charge admise	peso weight gewicht poids	prezzo price preis prix
		cm	mm	m3	kg	kg	euro

Hemingway

design Massimo Castagna 2020

R1 60 x 34 x h 7

R2 100 x 34 x h 7

12

12

0,02

0,033

15

15

9

15

330

350

RIPIANI E TRAVERSI / SHELVES AND BEAMS BÖDEN UND BALKEN / ETAGERES ET TRAVERS



Specificare la finitura del vetro EXTRACHIARO oppure FUME'
Always specify glass finish EXTRA CLEAR or SMOKED
Immer Glasversion angeben EXTRAHELL oder RAUCHGLAS
Indiquer toujours finition verre EXTRA CLAIR ou FUME.

Il ripiano di vetro è sempre abbinato a un traverso di legno, della stessa finitura del montante
Glass shelf is always combined with a wood beam of the same finish as the upright
Glasboden ist immer mit einem Hozbalken, in derselben Ausführung des Pfosten, kombiniert
Etagère en verre toujours combiné avec travers en bois, de la même finition du montant

- Ripiani in vetro extrachiaro o fumè. Fissaggio ad incastro su perni, con sistema di sicurezza anticaduta.
- Shelves in extra clear or smoked glass. Interlocking fixing on pins, with fall arrest security system.
- Böden aus extrahellem Glas oder Rauchglas. Einschnappbefestigung auf Bolzen, mit Sicherungssystem gegen Absturz
- Etagères en verre extra clair ou fumé. Fixage à encastrement sur pivots, avec système de sécurité antichute

Hemingway

design Massimo Castagna 2020

S1 100 x 60 x h 7

35

0,247

30

35

1.270

SCRITTOIO / DESK SCHREIBTISCH / BUREAU

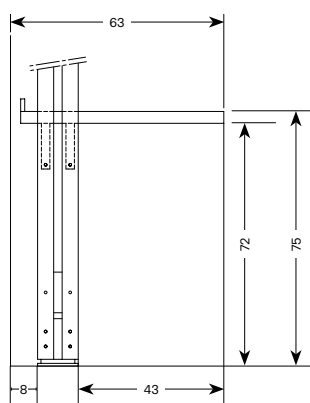

Specificare la finitura del legno SIBERIAN ASH oppure EUCALIPTO
Always specify wood finish SIBERIAN ASH or EUCALIPTO
Immer Holz Ausführung angeben SIBERIAN ASH oder EUCALIPTO
Indiquer toujours finition bois SIBERIAN ASH ou EUCALIPTO

- Scrivitoio in legno, finitura Siberian Ash o Eucalipto. Disponibile passacavi su richiesta.
- Wood desk, Siberian Ash or Eucalipto finish. Available cable entry on request.
- Holzschreibtisch, Ausführung Siberian Ash oder Eucalipto. Nach Anfrage Kabeldurchgang erhältlich.
- Bureau en bois, finition Siberian Ash ou Eucalipto. Disponible passe-câble sur demande.



S2 Optional passacavo quadrato 74mm nero.

Il foro passacavo sarà sempre al centro dello scrivitoio, salvo diversa indicazione.

Optional square cable entry 74mm black.

Cable entry is always in the center of the desk, unless otherwise specified.

Optionaler quadratischer Kabeldurchgang 74mm schwarz.

Kabeldurchgang ist immer in der Mitte des Schreibtisches, es sei denn andererseits angegeben.

Passe-câble optionnel carré 74mm noir.

Passe-câble toujours au centre du bureau, sauf indication différent.

120

	I	dimensioni	spessore	volume	carico ammesso	peso	prezzo
	E	dimension	thickness	volume	admitted load	weight	price
	D	abmessungen	stärke	volumen	tragfähigkeit	gewicht	preis
	F	dimension	épaisseur	volume	charge admise	poids	prix
		cm	mm	m3	kg	kg	euro

Hemingway

design Massimo Castagna 2020

CONTENITORI A RIBALTA
FLAP DOOR STORAGE UNIT
KIPPTÜR ELEMENT
RECIPIENT PORTE ABATTANT

C1	60 x 34 x h 29	8	0,126	15	32	1.720
C2	60 x 34 x h 39	8	0,165	15	43	1.790
C3	100 x 34 x h 29	8	0,218	15	37	1.890
C4	100 x 34 x h 39	8	0,267	15	48	1.990

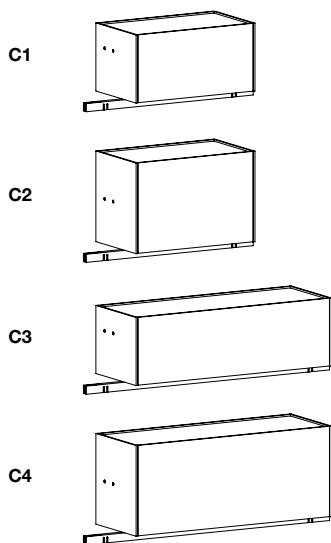

Specificare la finitura di anta e base in legno SIBERIAN ASH oppure EUCALIPTO
Specify wood finish of door and base SIBERIAN ASH or EUCALIPTO
Holzausführung der Tür und Bodenplatte angeben SIBERIAN ASH oder EUCALIPTO
Indiquer finition porte et base en bois SIBERIAN ASH ou EUCALIPTO

Il contenitore è sempre abbinato a un traverso in legno, della stessa finitura del montante.
Storage unit is always combined with a wood beam of the same finish as the upright.
Element mit Kipptür ist immer mit einem Hozbalken, in derselben Ausführung des Pfosten, kombiniert.
Récipients toujours combiné avec travers en bois, de la même finition du montant.

- Contenitori orizzontali con anta ribalta verso il basso, con struttura in vetro fumè.
- Anta e base in legno finitura Siberian Ash o Eucalipto.
- Horizontal storage units with flap-down door, structure in smoked glass.
- Door and base in wood Siberian Ash or Eucalipto finish.
- Waagrechte Elemente mit Kipptür, Struktur aus Rauchglas.
- Tür und Bodenplatte aus Holz in Ausführung Siberian Ash oder Eucalipto
- Récipients horizontaux avec porte abattant, structure en verre fumé.
- Porte et base en bois finition Siberian Ash ou Eucalipto.

Hemingway

design Massimo Castagna 2020

CONTENITORE BATTENTE
HINGE DOOR STORAGE UNIT
DREHFLÜGELTÜR ELEMENT
RECIPIENT PORTE A BATTANT

C5	60 x 34 x h 67	8	0,162	20	46	1.770
----	----------------	---	-------	----	----	-------

Specificare il verso di apertura dell'anta e la finitura in legno SIBERIAN ASH oppure EUCALIPTO
Always specify door opening and wood finish SIBERIAN ASH or EUCALIPTO
Immer Richtung der Türöffnung angeben und Holzausführung SIBERIAN ASH oder EUCALIPTO
Indiquer toujours vers ouverture de la porte et finition du bois SIBERIAN ASH ou EUCALIPTO

Il contenitore è sempre abbinato a un traverso in legno, della stessa finitura del montante.
Storage unit is always combined with a wood beam of the same finish as the upright.
Element mit Kipptür ist immer mit einem Hozbalken, in derselben Ausführung des Pfosten, kombiniert.
Récipients toujours combiné avec travers en bois, de la même finition du montant.

Un ripiano interno in legno incluso / one internal wooden shelf included
einschließlich ein internes Holzfach / un étagères en bois inclus

Optional portabicchieri in legno / optional wooden glass rack 240
optionaler Becherfach aus Holz / porte-gobelet optionnel en bois

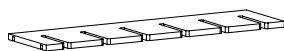

Optional cassetti in legno / optional wood drawers 780
Optionale Schubladen aus Holz / tiroirs optionnels en bois

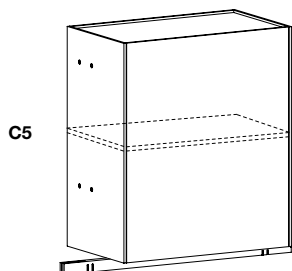
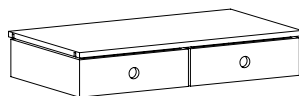

- Contenitore verticale con anta a battente destra o sinistra, con struttura in vetro fumè e anta in legno finitura Siberian Ash o Eucalipto.
- Vertical storage unit with hinged door right or left, with structure in smoked glass and wooden door Siberian Ash or Eucalipto finish.
- Senkrechtes Element mit Drehflügeltür rechts oder links, mit Struktur aus Rauchglas und Holz in Ausführung Siberian Ash oder Eucalipto.
- Récipient verticale avec porte à battant droite ou gauche, avec structure en verre fumé et porte en bois finition Siberian Ash ou Eucalipto.

	I E D F	dimensioni dimension abmessungen dimension	spessore thickness stärke épaisseur	volume volume volumen volume	carico ammesso admitted load tragfähigkeit charge admise	peso weight gewicht poids	prezzo price preis prix
		cm	mm	m3	kg	kg	euro

Hemingway

R3 160 x 34 x h 7

12

0,068

10

20

550

design Massimo Castagna 2020

RIPIANO E TRAVERSO MODULO TV
SHELVES AND BEAMS TV STORAGE UNIT
BÖDEN UND BALKEN TV ELEMENT
ETAGERES ET TRAVERS MODULE TV

R3



Specificare la finitura del vetro EXTRACHIARO oppure FUME'
Always specify glass finish EXTRA CLEAR or SMOKED
Immer Glasversion angeben EXTRAHELL oder RAUCHGLAS
Indiquer toujours finition verre EXTRA CLAIR ou FUME.

Il ripiano di vetro è sempre abbinato a un traverso di legno, della stessa finitura del montante.
Glass shelf is always combined with a wood beam of the same finish as the upright.
Glasboden ist immer mit einem Hozbalken, in derselben Ausführung des Pfosten, kombiniert.
Etagère en verre toujours combiné avec travers en bois, de la même finition du montant.

- Ripiani in vetro extrachiario o fumè per modulo TV. Fissaggio ad incastro su perni, con sistema di sicurezza anticaduta.
- Shelves in extra clear or smoked glass for TV module. Interlocking fixing on pins, with fall arrest security system.
- Böden aus extrahellem Glas oder Rauchglas für TV Modul. Einschnappbefestigung auf Bolzen, mit Sicherungssystem gegen Absturz.
- Etagères en verre extra clair ou fumé pour module TV. Fixage à encastrement sur pivots, avec système de sécurité antichute.

Hemingway

C6 160 x 34 x h 39

8

0,425

35

36

2.480

design Massimo Castagna 2020

CONTENITORE ORIZZONTALE MODULO TV
HORIZONTAL TV STORAGE UNIT
HORIZONTALES TV ELEMENT
RECIPIENT HORIZONTAL MODULE TV

C6

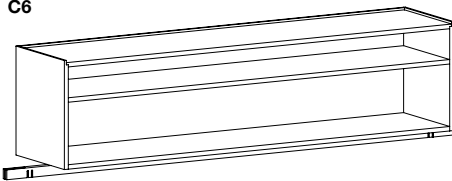

Specificare la finitura del legno SIBERIAN ASH oppure EUCALIPTO
Always specify wood finish SIBERIAN ASH or EUCALIPTO
Immer Holz Ausführung angeben SIBERIAN ASH oder EUCALIPTO
Indiquer toujours finition bois SIBERIAN ASH ou EUCALIPTO

Il contenitore è sempre abbinato a un traverso in legno, della stessa finitura del montante.
Storage unit is always combined with a wood beam of the same finish as the upright.
Element ist immer mit einem Hozbalken, in derselben Ausführung des Pfosten, kombiniert.
Réceptier toujours combiné avec travers en bois, de la même finition du montant.

Compreso nel prezzo passacavo diametro mm 60 su schienale. Specificare la posizione al momento dell'ordine.
Price includes Ø60mm cable entry on back panel. Always specify position when ordering.
Preis inklusiver Ø60mm Kabeldurchgang auf Rückseite. Bei Bestellung immer Position angeben.
Inclus dans le prix passe-câble Ø60mm sur dos. Spécifier toujours la position au moment de la commande.

Il ripiano R3 da cm 160 va sempre abbinato al contenitore orizzontale C6 e non può essere utilizzato per uso libreria. È sempre consigliato l'uso di due ripiani in abbinamento al contenitore C6. Per eventuali richieste speciali, rivolgersi al nostro ns. ufficio vendita.

R3 shelf of 160cm must always be combined with the C6 horizontal storage unit and cannot be used alone. We recommend to use two shelves combined with storage unit C6. For possible special requests contact our sales office.

R3 Fach in 160cm wird immer mit dem horizontalen Element C6 kombiniert und kann nicht alleine benutzt werden. Es wird empfohlen immer zwei Fächer in Kombination mit Element C6 zu benutzen. Für Spezialanfragen wenden Sie sich an unser Verkaufsbüro.

Etagères R3 de 160cm va toujours associer au réceptier horizontal C6 et ne peut pas être utiliser seul. Il est conseillé d'utiliser toujours deux étagères en combinaison avec le réceptier C6. Pour demandes spéciales contacter notre bureau de ventes.

- Contenitore a giorno per composizione TV. Struttura in legno e ripiano regolabile in altezza, finitura Siberian Ash o Eucalipto.
- Open storage unit for TV composition. Structure in wood and height adjustable shelf, finish Siberian Ash or Eucalipto
- Offenes Element für TV-Komposition. Struktur aus Holz und höhenverstellbares Fach Ausführung Siberian Ash oder Eucalipto.
- Réceptier ouvert pour composition TV. Structure en bois et étagère réglable en hauteur finition Siberian Ash ou Eucalipto.

S2 Optional passacavo quadrato 74 mm nero.
Optional square cable entry 74 mm black.
Optionaler quadratischer Kabeldurchgang 74 mm schwarz.
Passe-câble optionnel carré 74 mm noir.

120

S2



design Massimo Castagna 2020

Esempi di composizioni / Examples of compositions
Kompositionbeispiele / Examples de composition

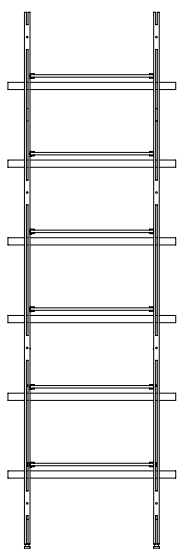

Comp. 201
81,4 x 37 x H 260 cm
2xM2 + 6xR1
Tot. 4.760 euro

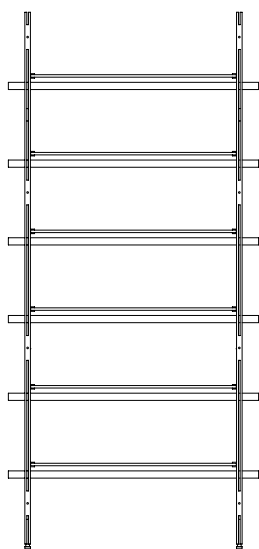

Comp. 203
121,4 x 37 x H 260 cm
2xM2 + 6xR2
Tot. 4.880 euro

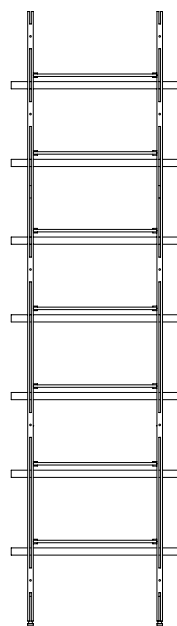

Comp. 205
81,4 x 37 x H 300 cm
2xM1 + 7xR1
Tot. 5.350 euro

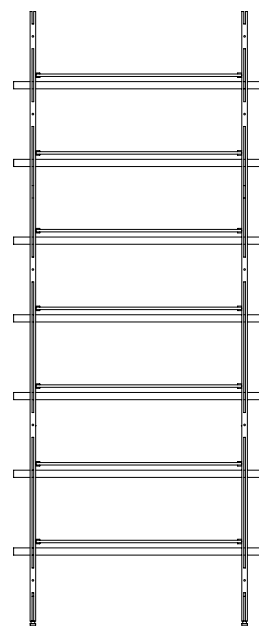

Comp. 207
121,4 x 37 x H 300 cm
2xM1 + 7xR2
Tot. 5.490 euro

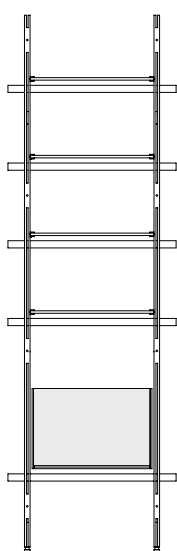

Comp. 209
81,4 x 37 x H 260 cm
2xM2 + 4xR1 + 1C2
Tot. 5.890 euro

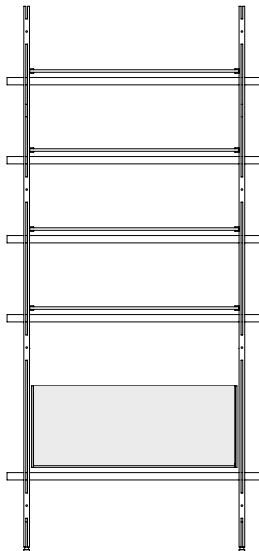

Comp. 211
121,4 x 37 x H 260 cm
2xM2 + 4xR2 + 1C4
Tot. 6.170 euro

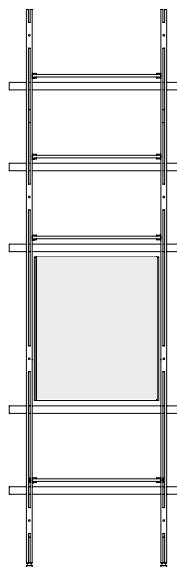

Comp. 213
81,4 x 37 x H 260 cm
2xM2 + 4xR1 + 1C5
Tot. 5.870 euro

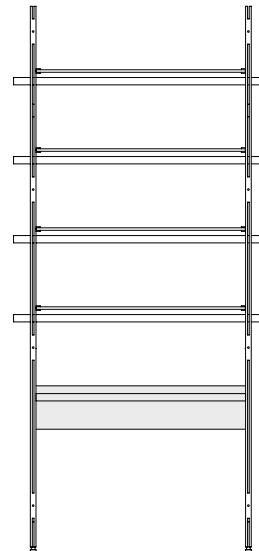

Comp. 215
121,4 x 63 x H 260 cm
2xM2 + 4xR2 + 1S1
Tot. 5.450 euro

Esempi di composizioni / Examples of compositions Kompositionbeispiele / Examples de composition

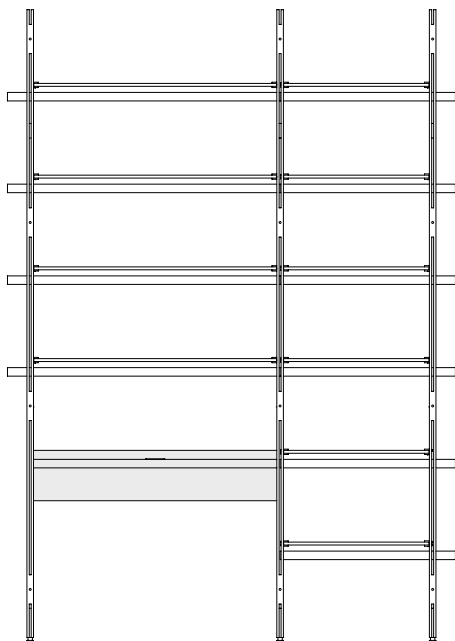

Comp. 303
184,1 x 63 x H 260 cm
3xM2 + 4xR2 + 6xR1 + 1xS1
Tot. 8.820 euro

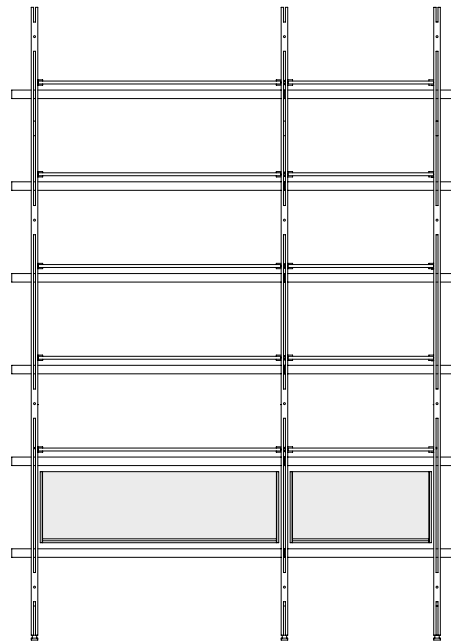

Comp. 305
184,1 x 37 x H 260 cm
3xM2 + 5xR2 + 5xR1 + 1xC3 + 1xC1
Tot. 11.180 euro

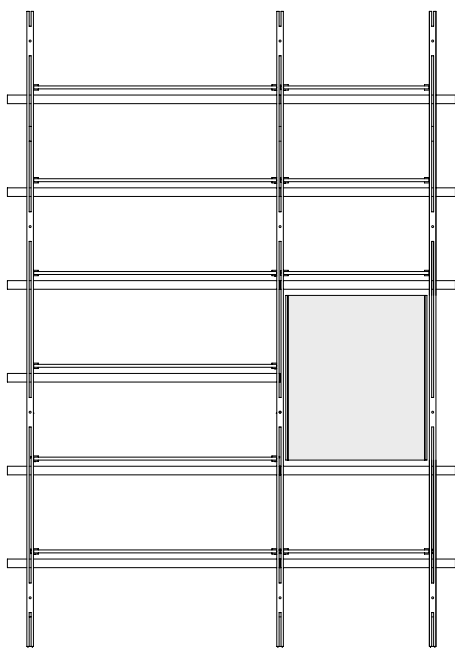

Comp. 307
184,1 x 37 x H 260 cm
3xM2 + 6xR2 + 4xR1 + 1xC5
Tot. 9.360 euro

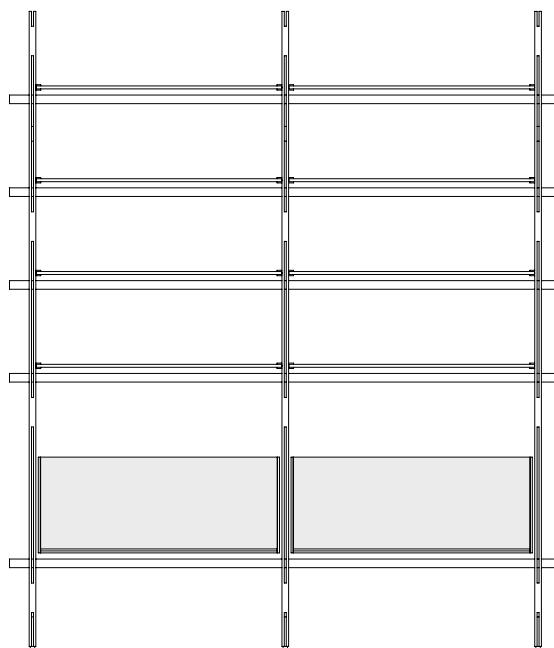

Comp. 311
224,1 x 63 x H 260 cm
3xM2 + 8xR2 + 2xC4
Tot. 10.950 euro

Esempi di composizioni / Examples of compositions Kompositionbeispiele / Examples de composition

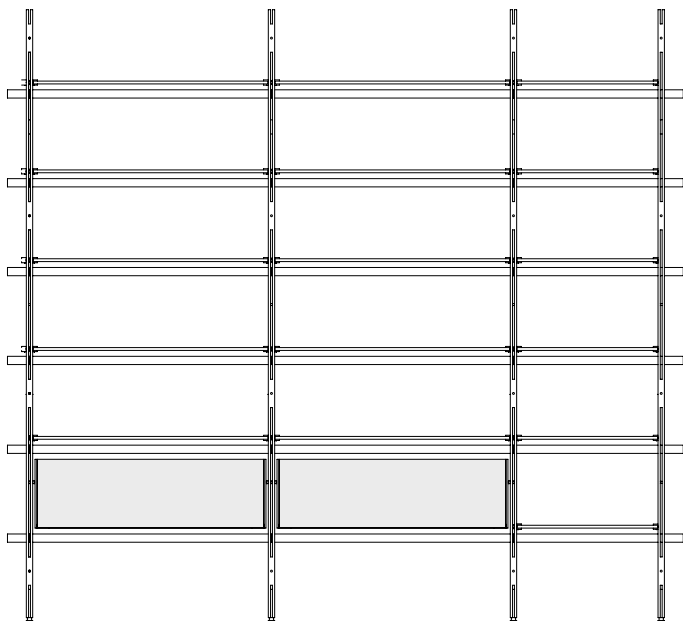

Comp. 401
286,8 x 37 x H 260 cm
4xM2 + 10xR2 + 6xR1 + 2xC3
Tot. 14.820 euro

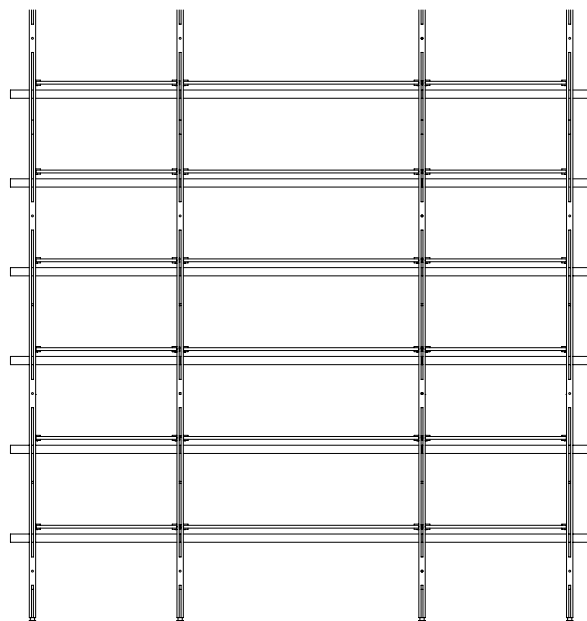

Comp. 403
246,8 x 37 x H 260 cm
4xM2 + 6xR2 + 12xR1
Tot. 11.620 euro

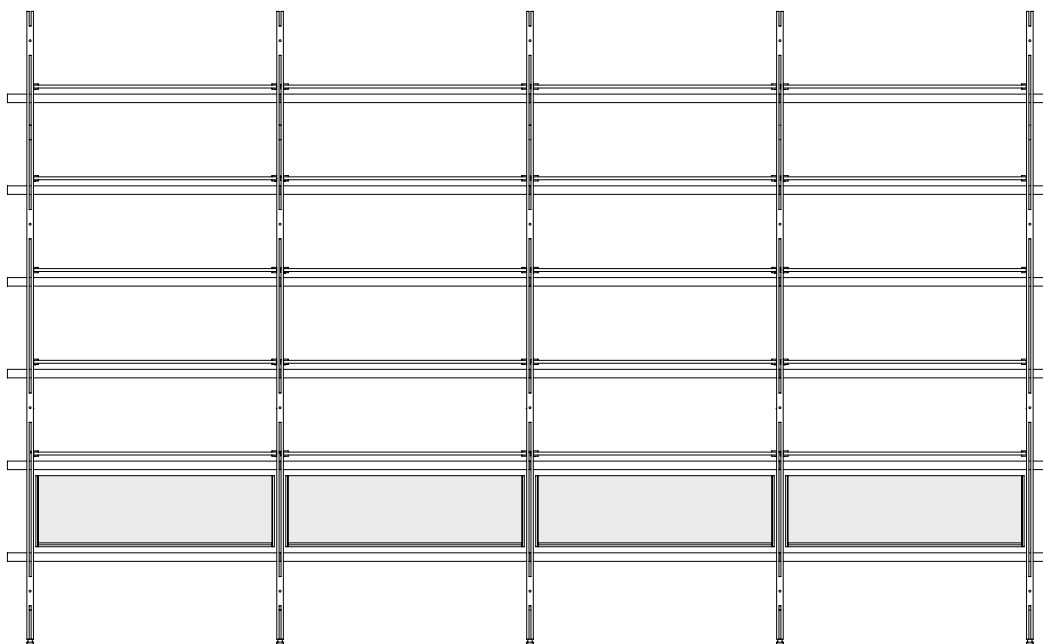

Comp. 503
429,5 x 37 x H 260 cm
5xM2 + 20xR2 + 4xC3
Tot. 21.510 euro

Esempi di composizioni / Examples of compositions
Kompositionbeispiele / Exemples de composition

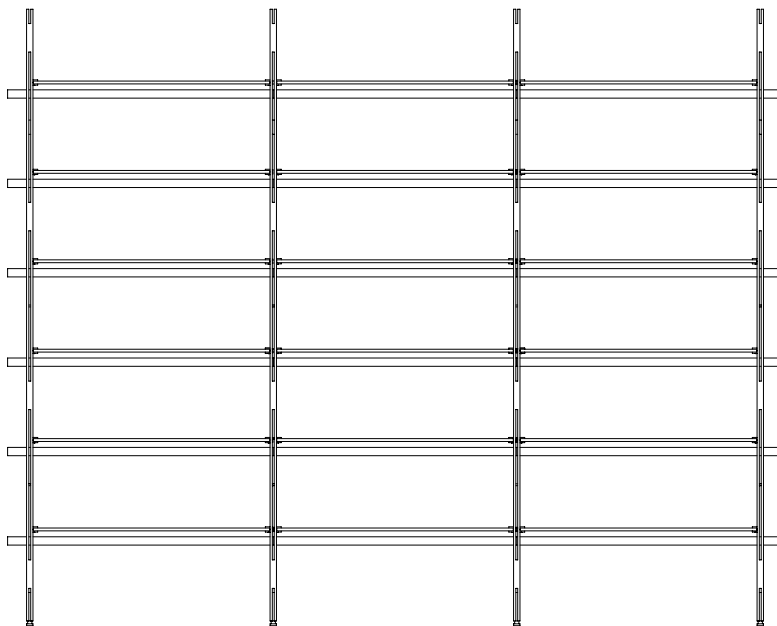

Comp. 405
326,8 x 37 x H 260 cm
4xM2 + 18xR2
Tot. 11.860 euro

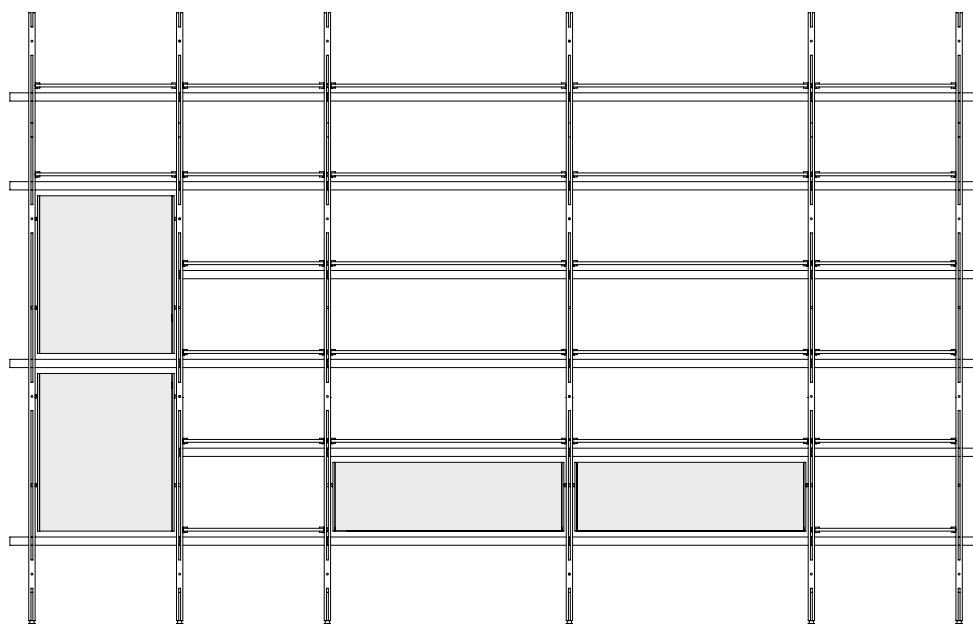

Comp. 601
412,2 x 37 x H 260 cm
6xM2 + 14xR1 + 10xR2 + 2xC5 + 2xC3
Tot. 23.780 euro

Esempi di composizioni / Examples of compositions Kompositionbeispiele / Examples de composition

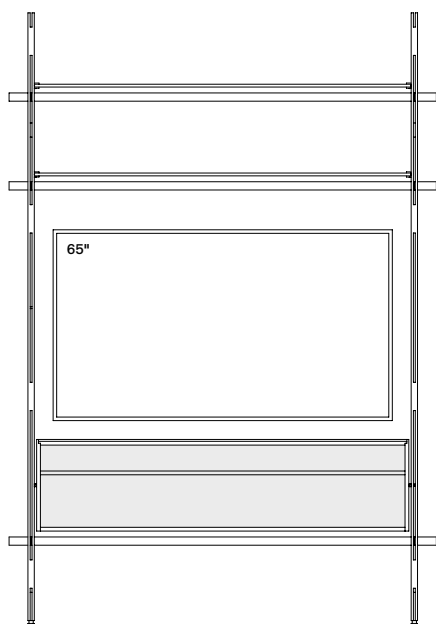

Comp. 217
181,4 x 37 x H 260 cm
2xM2 + 2xR3 + 1xC6
Tot. 6.360 euro

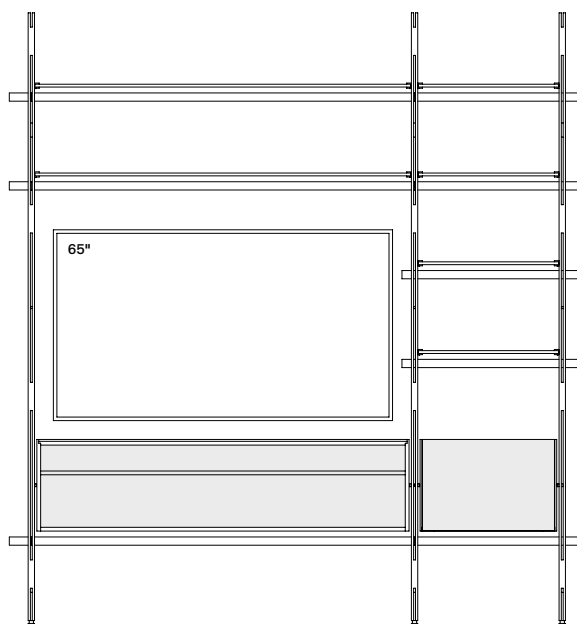

Comp. 309
244,1 x 37 x H 260 cm
3xM2 + 4xR1 + 2xR3 + 1xC2 + 1xC6
Tot. 10.860 euro

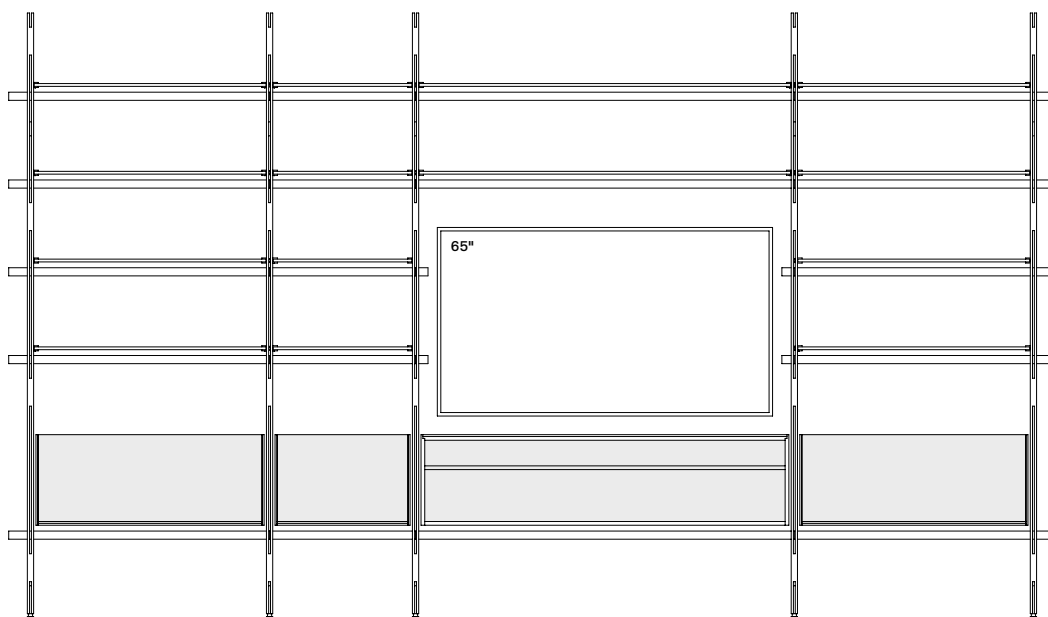

Comp. 501
449,5 x 37 x H 260 cm
5xM2 + 8xR2 + 4xR1 + 2xR3 + 2xC4 + 1xC6 + 1xC2
Tot. 20.420 euro

	I E D F	dimensioni dimension abmessungen dimension	spessore thickness stärke épaisseur	volume volume volumen volume	carico ammesso admitted load tragfähigkeit charge admise	peso weight gewicht poids	prezzo price preis prix
		cm	mm	m3	kg	kg	euro

Hybrid

design Massimo Castagna 2022

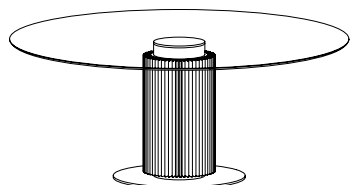

Ø 140 x h 75	12	0,57	150	168	<input type="checkbox"/> 7.880
					<input checked="" type="checkbox"/> 7.980
Ø 160 x h 75	12	0,62	150	192	<input type="checkbox"/> 8.620
					<input checked="" type="checkbox"/> 8.770
Ø 180 x h 75	12	0,69	150	202	<input type="checkbox"/> 8.960
					<input checked="" type="checkbox"/> 9.240

Maggiorazione base in finitura: **canna di fucile**

Upcharge base in **gunmetal**

Aufpreis für Gestell in **Gunmetal**

Surcharge pour piètement en **gunmetal**

180

Vetro extrachiaro / extra clear glass / extrahelles Glas / verre extra clair

Vetro fumé / smoked glass / Rauchglas / verre fumé

specificare sempre la finitura della base e dei listelli in legno massello.

always specify finish of base and solid wood strips.

immer Ausführung des Gestells und der Leisten aus massivem Holz angeben.

toujours spécifier la finition du piètement e des barres en bois massif.

- Tavolo con piano smussato sul bordo in vetro extra chiaro o fumé temperato. Basamento centrale composto da listelli in legno massello **Siberian Ash, Eucalipto o Rovere naturale** e parte superiore in metallo sempre in finitura cromato lucido. Base a terra in finitura cromato lucido o canna di fucile lucido.

- Dining table with beveled top in extra clear or smoked tempered glass. Central base made of solid wood strips in **Siberian Ash, Eucalipto or Natural oak** and metal upper part always in polished chrome finish. Bottom plate in polished chrome or polished gunmetal.

- Esstisch mit Top mit abgeschrägten Kanten aus Sicherheitsglas extrahell oder Rauchglas. Zentrales Gestell aus massiven Holzleisten in **Siberian ash, Eucalipto oder Eiche Natur** und oberes Metallteil immer in Chrom glänzend. Grundplatte in Ausführung Chrom glänzend oder Gunmetal glänzend.

- Table haute avec top biseauté en verre trempé extra clair ou fumé. Piètement central composé de barres en bois massif **Siberian Ash, Eucalipto ou Rouvre naturel** et partie supérieure en métal toujours en finition chrome brillant. Plateau au fond en finition chrome brillant ou gunmetal brillant.

	I E D F	dimensioni dimension abmessungen dimension	spessore thickness stärke épaisseur	volume volume volumen volume	carico ammesso admitted load tragfähigkeit charge admise	peso weight gewicht poids	prezzo price preis prix
		cm	mm	m3	kg	kg	euro

Hybrid

design Massimo Castagna 2022

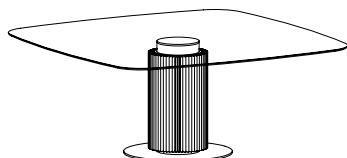

140 x 140 x h 75	12	0,57	150	181	<input type="checkbox"/> 7.950
					<input checked="" type="checkbox"/> 8.050
160 x 160 x h 75	12	0,62	150	207	<input type="checkbox"/> 8.660
					<input checked="" type="checkbox"/> 8.810
180 x 180 x h 75	12	0,69	150	219	<input type="checkbox"/> 8.990
					<input checked="" type="checkbox"/> 9.270

Maggiorazione base in finitura: **canna di fucile**

180

Upcharge base in **gunmetal**

Aufpreis für Gestell in **Gunmetal**

Surcharge pour piètement en **gunmetal**

Vetro extrachiaro / extra clear glass / extrahelles Glas / verre extra clair

Vetro fumé / smoked glass / Rauchglas / verre fumé

specificare sempre la finitura della base e dei listelli in legno massello.

always specify finish of base and solid wood strips.

immer Ausführung des Gestells und der Leisten aus massivem Holz angeben.

toujours spécifier la finition du piètement e des barres en bois massif.

Hybrid

design Massimo Castagna 2022

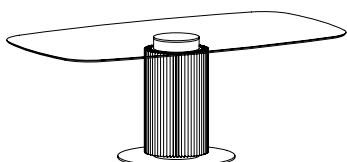

180 x 110 x h 75	12	0,59	150	177	<input type="checkbox"/> 8.330
					<input checked="" type="checkbox"/> 8.480
200 x 110 x h 75	12	0,62	150	186	<input type="checkbox"/> 8.510
					<input checked="" type="checkbox"/> 8.680

Maggiorazione base in finitura: **canna di fucile**

180

Upcharge base in **gunmetal**

Aufpreis für Gestell in **Gunmetal**

Surcharge pour piètement en **gunmetal**

Vetro extrachiaro / extra clear glass / extrahelles Glas / verre extra clair

Vetro fumé / smoked glass / Rauchglas / verre fumé

specificare sempre la finitura della base e dei listelli in legno massello.

always specify finish of base and solid wood strips.

immer Ausführung des Gestells und der Leisten aus massivem Holz angeben.

toujours spécifier la finition du piètement e des barres en bois massif.

- Tavolo con piano smussato sul bordo in vetro extra chiaro o fumé temperato. Basamento centrale composto da listelli in legno massello **Siberian Ash, Eucalipto o Rovere naturale** e parte superiore in metallo sempre in finitura cromato lucido. Base a terra in finitura cromato lucido o canna di fucile lucido.

- Dining table with beveled top in extra clear or smoked tempered glass. Central base made of solid wood strips in **Siberian Ash, Eucalipto or Natural oak** and metal upper part always in polished chrome finish. Bottom plate in polished chrome or polished gunmetal.

- Esstisch mit Top mit abgeschrägten Kanten aus Sicherheitsglas extrahell oder Rauchglas. Zentrales Gestell aus massiven Holzleisten in **Siberian ash, Eucalipto oder Eiche Natur** und oberes Metallteil immer in Chrom glänzend. Grundplatte in Ausführung Chrom glänzend oder Gunmetal glänzend.

- Table haute avec top biseauté en verre trempé extra clair ou fumé. Piètement central composé de barres en bois massif **Siberian Ash, Eucalipto ou Rouvere naturel** et partie supérieure en métal toujours en finition chrome brillant. Plateau au fond en finition chrome brillant ou gunmetal brillant.

	I E D F	dimensioni dimension abmessungen dimension	spessore thickness stärke épaisseur	volume volume volumen volume	carico ammesso admitted load tragfähigkeit charge admise	peso weight gewicht poids	prezzo price preis prix
		cm	mm	m3	kg	kg	euro

Hyperion

design Massimo Castagna 2020

A	75 x 74 x h 130			0,62		16	2.480
							● 2.730
B	60 x 60 x h 122			0,27		15	2.120
							● 2.330

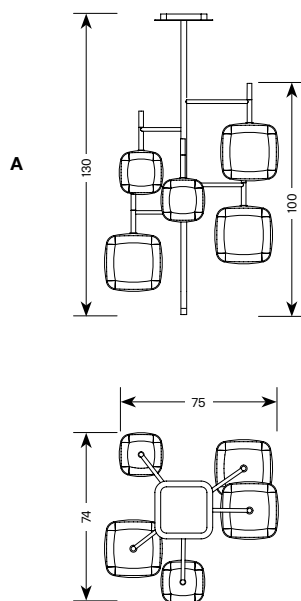

- Lampadine dimmerabili **G9** 3000K 4/5 max 5W 2000/2500 lm.
Dimmable bulbs **G9** 3000K 4/5 max 5W 2000/2500 lm.
Dimmbare Birnen **G9** 3000K 4/5 max 5W 2000/2500lm.
Ampoules gradables **G9** 3000K 4/5 max 5W 2000/2500lm.

Supplemento per altezza su misura da > a Upcharge for custom height from > to Aufpreis für Sonderhöhe von > bis Supplément pour hauteur sur mesure de > à	
110 > 121/129	euro 120
123/131 > 160	euro 160
161 > 200	euro 200
201 > 250	euro 270
251 > 300	euro 340
301 > 350	euro 410
351 > 400	euro 480
401 > 450	euro 550
451 > 500	euro 620
501 > 550	euro 690
551 > 600	euro 760

specificare sempre la finitura del telaio in metallo
always specify finish of metal frame
immer Ausführung des Metallgestell angeben
toujours spécifier finition de l'armature en métal

specificare il paese di destinazione
specify country of destination
immer Zielland angeben
toujours indiquer pays de destination

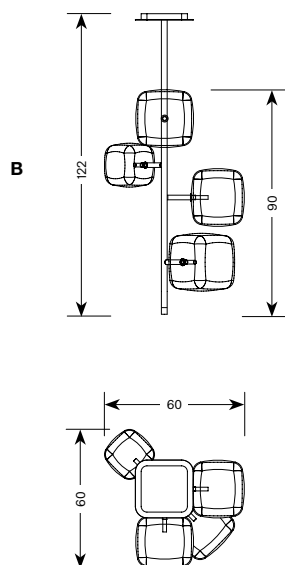

- Lampada a sospensione a luce LED, 4 o 5 cubi in vetro pyrex soffiato trasparente. Lampadine dimmerabili G4 3000K 4/5 x max 4W 1200/1500lm. Parti metalliche disponibili nelle finiture cromo lucido, oro lucido e canna di fucile lucido. L'altezza può essere realizzata a misura, da un minimo di 110 cm ad un massimo di 600 cm totali.
- Hanging lamp with LED lights, 4 or 5 transparent blown pyrex glass cubes. Dimmable bulbs G4 3000K 4/5 x max 4W 1200/1500lm. Metal parts available in polished chrome, polished gold and polished gunmetal finish. Custom height available, from minimum 110cm to maximum 600 cm total.
- Hängelampe mit Led Beleuchtung, 4 oder 5 Würfel aus transparentem geblasenem Pyrex Glas. Dimmbare Birnen G4 3000K 4/5 x max 4W 1200/1500lm. Metallteile erhältlich in Chrom glänzend, gold glänzend oder Gunmetal glänzend. Die Höhe kann auf Maß gefertigt werden, von mindestens 110 cm bis maximal 600 cm insgesamt.
- Lampe à suspension avec lumière LED, 4 ou 5 cubes en verre soufflé pyrex transparent. Ampoules gradables G4 3000K 4/5 x max 4W 1200/1500lm. Parts en métal disponible en finition chrome brillant, or brillant ou gunmetal brillant. Hauteur disponible sur mesure, de minimum 110cm à maximum 600 cm total.

Su richiesta è disponibile, già cablato nelle lampade, il sistema di alimentazione per impianti di domotica **DALI 1** e **DALI 2**. Per informazioni e costi rivolgersi al ns. ufficio vendite.

Available on request, already wired in the lamps, power supply system for home automation system **DALI 1** and **DALI 2**. For information and pricing contact our sales office.

Verfügbar nach Anfrage, bereits in den Lampen verkabelt, Stromversorgung für Domotik System **DALI 1** und **DALI 2**. Für Informationen und Preise unser Verkaufsbüro kontaktieren.

Disponible sur demande, déjà câblé dans les lampes, système d'alimentation pour système domotique **DALI 1** et **DALI 2**. Pour information et prix contacter notre bureau de ventes.

	I	dimensioni	spessore	volume	carico ammesso	peso	prezzo
	E	dimension	thickness	volume	admitted load	weight	price
	D	abmessungen	stärke	volumen	tragfähigkeit	gewicht	preis
	F	dimension	épaisseur	volume	charge admise	poids	prix
		cm	mm	m3	kg	kg	euro

Hyperion

design Massimo Castagna 2020

C	19 x 19 x h 49			0,030		6	580
D	25 x 25 x h 62			0,065		7	660

**Il trasformatore va sempre posizionato nel controsoffitto o all'interno della scatola di derivazione.
The transformer must always be placed in the false ceiling or inside the junction box.
Der Trafo muss immer in die Zwischendecke platziert werden oder in der Anschlussdose.
Le transformateur doit être toujours placé dans le faux plafond ou le boîtier de jonction.**

**specificare sempre la finitura del telaio in metallo
always specify finish of metal frame
immer Ausführung des Metallgestell angeben
toujours spécifier finition de l'armature en métal**

specificare il paese di destinazione
specify country of destination
immer Zielland angeben
toujours indiquer pays de destination

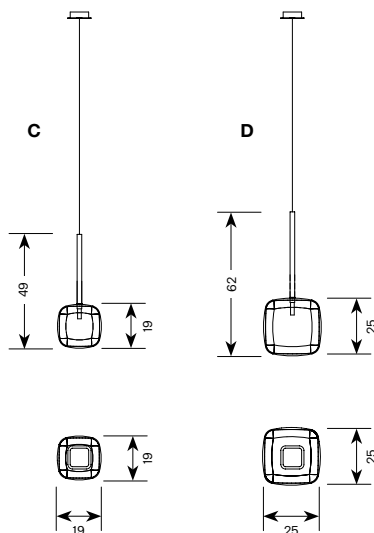

- Lampada a sospensione a luce LED, Cubo in vetro pyrex soffiato trasparente. Lampadina dimmerabile 4G 3000K max 4W 300lm. Parti metalliche disponibili nelle finiture cromo lucido, oro lucido e canna di fucile lucido. In dotazione cavo da 4 mt.
- Hanging lamp with LED lights, cube in transparent blown pyrex glass. Dimmable bulb 4G 3000K max 4W 300lm. Metal parts available in polished chrome, polished gold and polished gunmetal finish. Supplied with 4 mt long cable.
- Hängelampe mit Led Beleuchtung, Würfel aus transparentem geblasenem Pyrex Glas. Dimmbare Birne 4G 3000K max 4W 300lm. Metallteile erhältlich in Chrom glänzend, gold glänzend oder Gunmetal glänzend. Wird mit 4m langem Kabel geliefert.
- Lampe à suspension avec lumière LED, cube en verre soufflé pyrex transparent. Ampoule gradable 4G 3000K max 4W 300lm. Parts en métal disponible en finition chrome brillant, or brillant ou gunmetal brillant. En dotation cable de 4 mt.

Hyperion

design Massimo Castagna 2020

E	60 x 60 x h 180			0,58		19	2.190
---	-----------------	--	--	------	--	----	-------

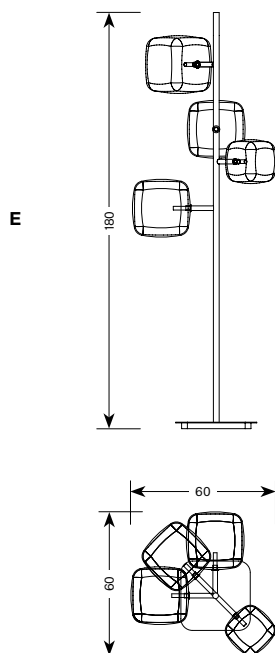

- Lampada da terra a luce LED, 4 cubi in vetro pyrex soffiato trasparente. Lampadine dimmerabili G4 3000K 4 x max 4W 1200lm. Parti metalliche disponibili nelle finiture cromo lucido, oro lucido e canna di fucile lucido.
- Floor lamp with LED lights, 4 cubes in transparent blown pyrex glass. Dimmable bulbs G4 3000K 4 x max 4W 1200lm. Metal parts available in polished chrome, polished gold and polished gunmetal finish.
- Stehlampe mit LED Beleuchtung, 4 Würfel aus transparentem geblasenem Pyrex Glas. Dimmbare Birnen G4 3000K 4 x max 4W 1200lm. Metallteile erhältlich in Chrom glänzend, gold glänzend oder Gunmetal glänzend.
- Lampadaire avec lumière LED (H1,5W - led (G4) 180 lm, 3000K). 4 cubes en verre soufflé pyrex transparent. Ampoules gradables G4 3000K 4 x max 4W 1200lm. Parts en métal disponible en finition chrome brillant, or brillant ou gunmetal brillant.

	I	dimensioni	spessore	volume	carico ammesso	peso	prezzo
	E	dimension	thickness	volume	admitted load	weight	price
	D	abmessungen	stärke	volumen	tragfähigkeit	gewicht	preis
	F	dimension	épaisseur	volume	charge admise	poids	prix
		cm	mm	m3	kg	kg	euro

Hyperion

design Massimo Castagna 2021

F 23 x 23 x h 39

G 30 x 30 x h 34

0,089

0,107

5

7

690

750

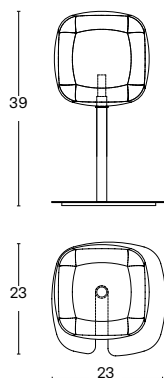

F

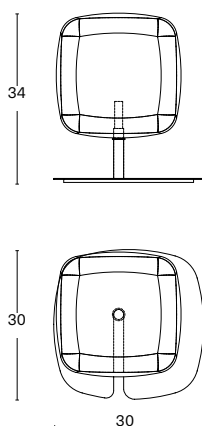

G

specificare sempre la finitura del telaio in metallo
always specify finish of metal frame
immer Ausführung des Metallgestell angeben
toujours spécifier finition de l'armature en métal

specificare il paese di destinazione
specify country of destination
immer Zielland angeben
toujours indiquer pays de destination

- Lampada da tavolo a luce LED, cubo in vetro pyrex soffiato trasparente. Lampadina dimmerabile G9 3000K max 2,5W 200lm. Parti metalliche disponibili nelle finiture cromo lucido, oro lucido e canna di fucile lucido.
- Table lamp with LED lights, cube in transparent blown pyrex glass. Dimmable bulb G9 3000K max 2,5W 200lm. Metal parts available in polished chrome, polished gold and polished gunmetal finish.
- Tischlampe mit Led Beleuchtung, Würfel aus transparentem geblasenem Pyrex Glas. Dimmbare Birne G9 3000K max 2,5W 200lm. Metallteile erhältlich in Chrom glänzend, gold glänzend oder Gunmetal glänzend.
- Lampe de bureau avec lumière LED, cube en verre soufflé pyrex transparent. Ampoule gradable G9 3000K max 2,5W 200lm. Parts en métal disponible en finition chrome brillant, or brillant ou gunmetal brillant.

	I E D F	dimensioni dimension abmessungen dimension	spessore thickness stärke épaisseur	volume volume volumen volume	carico ammesso admitted load tragfähigkeit charge admise	peso weight gewicht poids	prezzo price preis prix
		cm	mm	m3	kg	kg	euro

Il paese delle meraviglie

design Paolo Lomazzi 2018

Turchina	Ø 60 x h.52	10	0,30	20	31	1.380
-----------------	-------------	----	------	----	----	--------------

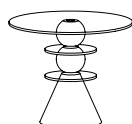

Cenerentola	Ø 60 x h.52	10	0,30	20	31	1.440
--------------------	-------------	----	------	----	----	--------------

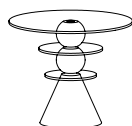

Maramao	Ø 60 x h.38	10	0,21	20	29	1.260
----------------	-------------	----	------	----	----	--------------



Marameo	Ø 50 x h.52	10	0,30	20	31	1.450
----------------	-------------	----	------	----	----	--------------

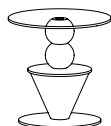

Alice alta	Ø 50 x h.63	10	0,30	20	28	1.570
-------------------	-------------	----	------	----	----	--------------

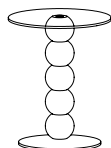

Alice bassa	Ø 60 x h.27	10	0,17	20	22	980
--------------------	-------------	----	------	----	----	------------

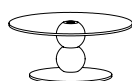

- Serie di tavolini. Piani orizzontali in vetro, struttura realizzata con miscela di frammenti di vetro neutro o colorato.
- Series of small tables. Horizontal panels in glass, structure made of a mix of glass shards in neutral or coloured glass.
- Vielzahl von kleinen Tischen. Horizontale Platten aus Glas, Struktur ist ein Mix von neutralen oder farbigen Glasscherben.
- Série de petites tables. Panneaux horizontaux en verre. Structure réalisé avec un mélange de fragments de verre neutre ou coloré.

	I E D F	dimensioni dimension abmessungen dimension	spessore thickness stärke épaisseur	volume volume volumen volume	carico ammesso admitted load tragfähigkeit charge admise	peso weight gewicht poids	prezzo price preis prix
		cm	mm	m3	kg	kg	euro

Joliet

design Giulio Mancini 2011 / 2019

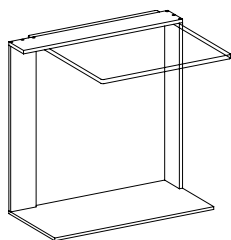

STRUTTURA VERNICIATA NERO / STRUCTURE BLACK LACQUERED / STRUKTUR SCHWARZ LACKIERT / STRUCTURE LAQUÉ NOIR

50 x 40 x h 50	12	0,08	20	23	1.030
					□ 1.050
					■ 1.060
50 x 40 x h 65	12	0,1	20	24	1.060
					□ 1.080
					■ 1.090

STRUTTURA VERNICIATA BIANCO / STRUCTURE WHITE LACQUERED / STRUKTUR WEISS LACKIERT / STRUCTURE LAQUÉ BLANC

50 x 40 x h 50	12	0,08	20	23	1.040
					□ 1.060
					■ 1.070
50 x 40 x h 65	12	0,1	20	24	1.070
					□ 1.090
					■ 1.100

STRUTTURA CROMATA / STRUCTURE CHROME / STRUKTUR CHROM / STRUCTURE CHROMÈ

50 x 40 x h 50	12	0,08	20	23	1.200
					□ 1.220
					■ 1.230
50 x 40 x h 65	12	0,1	20	24	1.230
					□ 1.250
					■ 1.260

STRUTTURA CANNA DI FUCILE / GUNMETAL STRUCTURE / GUNMETAL STRUKTUR / STRUCTURE GUNMETAL

50 x 40 x h 50	12	0,08	20	23	1.480
					□ 1.500
					■ 1.510
50 x 40 x h 65	12	0,1	20	24	1.510
					□ 1.530
					■ 1.540

- top vetro extrachiaro / extra clear glass top / Glasplatte extrahell / Plateau en verre extra clair
 ■ top vetro fumè / smoked glass top / Rauchglasplatte / plateau en verre fumè

- Tavolino multiuso o comodino. Struttura in metallo cromato, canna di fucile, verniciato nero o bianco opaco.
 Top in vetro trasparente, extrachiaro o fumè. Disponibile in due altezze.
 - Side table or bedside table. Structure in chrome, gunmetal, matt black or white lacquered.
 Top in transparent, extra clear or smoked glass. Available in two heights.
 - Beistelltisch oder Nachttisch. Struktur in Chrom, Gunmetal, matt schwarz oder weiß lackiert.
 Top aus transparentem, extrahellem Glas oder Rauchglas. In zwei Höhen erhältlich.
 - Table de chevet ou table de nuit en verre transparent, extra clair ou fume. Structure chrome, gunmetal, laqué noir ou blanc mat.

	I E D F	dimensioni dimension abmessungen dimension	spessore thickness stärke épaisseur	volume volume volumen volume	carico ammesso admitted load tragfähigkeit charge admise	peso weight gewicht poids	prezzo price preis prix
		cm	mm	m3	kg	kg	euro
Kart		86 x 38 x h 86	12	0,52	40	103	2.880
design Karim Rashid 2015							

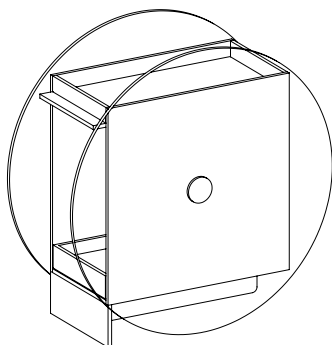

- Carrello bar in vetro extrachiaro satinato e grandi ruote in vetro extrachiaro. Vassoio estraibile in legno laccato nero opaco.
- Bar trolley in extra clear frosted glass and big extra clear glass wheels. Pullout tray in black matt lacquered wood.
- Barwagen in extrahell satiniertes Glas und große Räder aus extrahellem Glas. Ausziehbares Tablett aus matt schwarz lackiertem Holz.
- Table roulante en verre extra clair satiné et grand roulettes en verre extra clair. Plateau extractible en bois laqué noir mat.

Kat	A - 88 x 63 x h 36	12	0,41	30	37	1.090
	B - 131 x 74 x h 36	12	0,43	30	41	1.320
design Karim Rashid 2008						

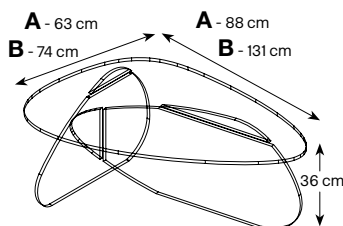

- Tavolino in vetro trasparente, acidato e fumè.
- Cocktail table with transparent, frosted and smoked glass.
- Couchtisch in transparentem, geätzttem Glas und Rauchglas.
- Table bas en verre transparent, mordancé et fumé.

Lingo	34 x 34 x h 70		0,2		28	● 760 ●● 780 ●●● 790
design Roberto Garbugli 2008						

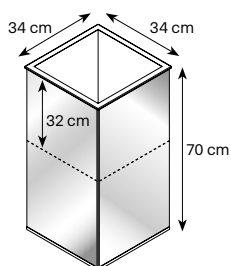

- Specchio / Mirror / Spiegel / Miroir
- Specchio fumè / Smoked mirror / Rauchglasspiegel / miroir fumé
- Specchio bronzo / Bronze mirror / Bronze Spiegel / Miroir bronze

- Vaso a specchio con struttura interna in legno e cornice in acciaio inox.
- Vase in mirror with inner wooden support and frame in stainless steel.
- Blumenvase aus Spiegel mit interner Struktur aus Holz und Rahmen aus Edelstahl.
- Vase en miroir avec structure intérieur en bois et cadre en inox.

	I E D F	dimensioni dimension abmessungen dimension	spessore thickness stärke épaisseur	volume volume volumen volume	carico ammesso admitted load tragfähigkeit charge admise	peso weight gewicht poids	prezzo price preis prix
		cm	mm	m3	kg	kg	euro

Liber A

design Luca Papini 2013/2022

80 x 40 x h 200	10 / 12	0,99	15*	130	2.740
					□ 2.950
					■ 3.080
80 x 40 x h 240	10 / 12	1,19	15*	165	2.990
					□ 3.280
					■ 3.390

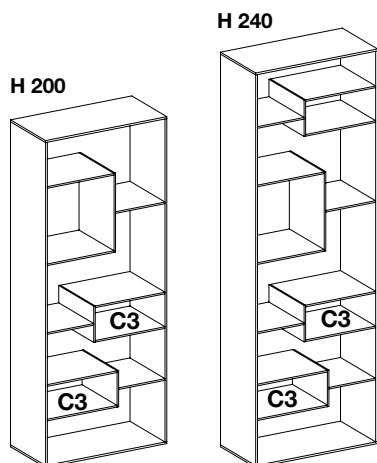

Optional CASSETTO C3 / Optional CASSETTO C3 Opzional CASSETTO C3 / Optionnel CASSETTO C3

- * ogni ripiano / on each shelf / auf jedem Bord / pour chaque étagère
 Vetro extrachiaro / extra clear glass / extrahelles Glas / verre extra clair
 Vetro fumé / smoked glass / Rauchglas / verre fumé

Ripiano superiore cassetto in vetro acidato / laccato ral / vetro a specchio 100
 Top drawer shelf in frosted glass / ral lacquered glass / mirrored glass
 Glasplatte über Laden in geätztem/ral lackiertem / verspiegeltem Glas
 Étagère supérieur tiroir en verre mordancé / lacqué ral / miroir

- Libreria o espositore in vetro con base a specchio e piedini regolabili. Cassetti optional.
 - Glass bookcase or showcase with mirrored base and adjustable feet. Optional drawers.
 - Bücherregal oder Regal aus Glas mit verspiegeltem Boden und regelbaren Füßen. Optionale Schubladen.
 - Bibliothèque ou présentoir en verre avec base en miroir e pieds réglables. Tiroirs optionnels.

Liber B

design Luca Papini 2013/2022

40 x 40 x h 200	10 / 12	0,56	15*	100	2.250
					□ 2.410
					■ 2.530
40 x 40 x h 240	10 / 12	0,67	15*	118	2.480
					□ 2.660
					■ 2.800

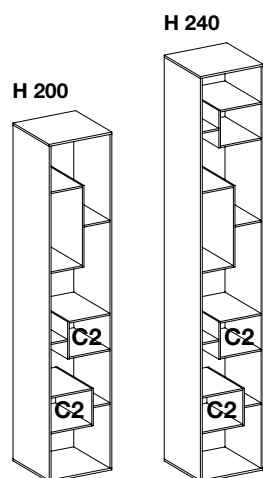

Optional CASSETTO C2 / Optional CASSETTO C2 Opzional CASSETTO C2 / Optionnel CASSETTO C2

- * ogni ripiano / on each shelf / auf jedem Bord / pour chaque étagère
 Vetro extrachiaro / extra clear glass / extrahelles Glas / verre extra clair
 Vetro fumé / smoked glass / Rauchglas / verre fumé

Ripiano superiore cassetto in vetro acidato / laccato ral / vetro a specchio 80
 Top drawer shelf in frosted glass / ral lacquered glass / mirrored glass
 Glasplatte über Laden in geätztem/ral lackiertem / verspiegeltem Glas
 Étagère supérieur tiroir en verre mordancé / lacqué ral / miroir

- Libreria o espositore in vetro con base a specchio e piedini regolabili. Cassetti optional.
 - Glass bookcase or showcase with mirrored base and adjustable feet. Optional drawers.
 - Bücherregal oder Regal aus Glas mit verspiegeltem Boden und regelbaren Füßen. Optionale Schubladen.
 - Bibliothèque ou présentoir en verre avec base en miroir e pieds réglables. Tiroirs optionnels.

	I E D F	dimensioni dimension abmessungen dimension	spessore thickness stärke épaisseur	volume volume volumen volume	carico ammesso admitted load tragfähigkeit charge admise	peso weight gewicht poids	prezzo price preis prix
		cm	mm	m3	kg	kg	euro

Liber D

design Luca Papini 2013/2019

40 x 40 x h 80	10 / 12	0,3	15*	51	1.290
					□ 1.410
					■ 1.480

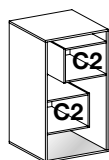

Optional CASSETTO C2 / Optional CASSETTO C2 Opzional CASSETTO C2 / Optionnel CASSETTO C2

- * ogni ripiano / on each shelf / auf jedem Bord / pour chaque étagère
- Vetro extrachiaro / extra clear glass / extrahelles Glas / verre extra clair
- Vetro fumé / smoked glass / Rauchglas / verre fumé

Ripiano superiore cassetto in vetro acidato / laccato ral / vetro a specchio **80**
 Top drawer shelf in frosted glass / ral lacquered glass / mirrored glass
 Glasplatte über Laden in geätztem/ral lackiertem / verspiegeltem Glas
 Étagère supérieur tiroir en verre mordancé / lacqué ral / miroir

Libreria o espositore in vetro con base a specchio e piedini regolabili. Cassetti optional.
 - Glass bookcase or showcase with mirrored base and adjustable feet. Optional drawers.
 - Bücherregal oder Regal aus Glas mit verspiegeltem Boden und regelbaren Füßen. Optionale Schubladen.
 - Bibliothèque ou présentoir en verre avec base en miroir e pieds réglables. Tiroirs optionnels.

Liber E-F

design Luca Papini 2013/2019

E 40 x 40 x h 40	10 / 12	0,14	15*	30	960
					□ 1.020
					■ 1.060
F 40 x 40 x h 60	12 / 10	0,18	15*	38	990
					□ 1.060
					■ 1.110

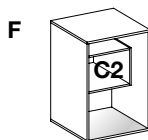

Optional CASSETTO C2 / Optional CASSETTO C2 Opzional CASSETTO C2 / Optionnel CASSETTO C2

- * ogni ripiano / on each shelf / auf jedem Bord / pour chaque étagère
- Vetro extrachiaro / extra clear glass / extrahelles Glas / verre extra clair
- Vetro fumé / smoked glass / Rauchglas / verre fumé

Ripiano superiore cassetto in vetro acidato / laccato ral / vetro a specchio **80**
 Top drawer shelf in frosted glass / ral lacquered glass / mirrored glass
 Glasplatte über Laden in geätztem/ral lackiertem / verspiegeltem Glas
 Étagère supérieur tiroir en verre mordancé / lacqué ral / miroir

- Fianco divano o comodino in vetro con base a specchio. Cassetti optional.
 - End table or bed side table in glass with mirrored base. Optional drawers.
 - Abstellisch oder Nachttisch aus Glas mit Spiegelboden. Optionale Schubladen.
 - Petite table ou chevet en verre avec base en miroir. Tiroirs optionnels.

	I E D F	dimensioni dimension abmessungen dimension	spessore thickness stärke épaisseur	volume volume volumen volume	carico ammesso admitted load tragfähigkeit charge admise	peso weight gewicht poids	prezzo price preis prix
		cm	mm	m3	kg	kg	euro
Liber G		80 x 40 x h 60	12 / 10	0,18	15*	58	1.310
design Luca Papini 2015/2019							□ 1.410
							■ 1.480

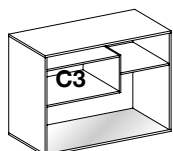

Optional CASSETTO C3 / Optional CASSETTO C3 / Opzional CASSETTO C3 / Optionnel CASSETTO C3

* ogni ripiano / on each shelf / auf jedem Bord / pour chaque étagère

□ Vetro extrachiaro / extra clear glass / extrahelles Glas / verre extra clair

■ Vetro fumé / smoked glass / Rauchglas / verre fumé

Ripiano superiore cassetto in vetro acidato / laccato ral / vetro a specchio 100

Top drawer shelf in frosted glass / ral lacquered glass / mirrored glass

Glasplatte über Laden in geätztem/ral lackiertem / verspiegeltem Glas

Etagère supérieur tiroir en verre mordancé / lacqué ral / miroir

- Fianco divano o comodino in vetro con base a specchio e piedini regolabili. Cassetti optional.

- End table or bed side table in glass with mirrored base. Optional drawers.

- Abstelltisch oder Nachttisch aus Glas mit Spiegelboden. Optionale Schubladen.

- Petite table ou chevet en verre avec base en miroir. Tiroirs optionnels.

Liber H		80 x 40 x h 80	12 / 10	0,41	15*	68	1.420
design Luca Papini 2015/2019							□ 1.560
							■ 1.640

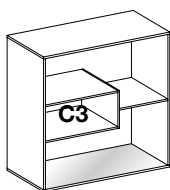

Optional CASSETTO C3 / Optional CASSETTO C3 / Opzional CASSETTO C3 / Optionnel CASSETTO C3

* ogni ripiano / on each shelf / auf jedem Bord / pour chaque étagère

□ Vetro extrachiaro / extra clear glass / extrahelles Glas / verre extra clair

■ Vetro fumé / smoked glass / Rauchglas / verre fumé

Ripiano superiore cassetto in vetro acidato / laccato ral / vetro a specchio 100

Top drawer shelf in frosted glass / ral lacquered glass / mirrored glass

Glasplatte über Laden in geätztem/ral lackiertem / verspiegeltem Glas

Etagère supérieur tiroir en verre mordancé / lacqué ral / miroir

- Consolle in vetro con base a specchio e piedini regolabili. Cassetti optional.

- Console in glass with mirrored base and adjustable feet. Optional drawers.

- Konsole aus Glas mit verspiegeltem Boden und verstellbaren Füßen. Optionale Schubladen.

- Console en verre avec base en miroir et pieds réglables. Tiroirs optionnels.

	I E D F	dimensioni dimension abmessungen dimension	spessore thickness stärke épaisseur	volume volume volumen volume	carico ammesso admitted load tragfähigkeit charge admise	peso weight gewicht poids	prezzo price preis prix
		cm	mm	m3	kg	kg	euro
Liber M		200 x 40 x h 60	10 / 12	0,56	60 + 15*	104	2.520
design Luca Papini 2013/2019							□ 2.730
							■ 2.860

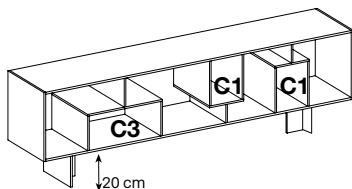

Optional CASSETTO C1 - C3 / Optional CASSETTO C1 - C3
Opzional CASSETTO C1 - C3 / Optionnel CASSETTO C1 - C3

- * ogni ripiano / on each shelf / auf jedem Bord / pour chaque étagère
□ Vetro extrachiaro / extra clear glass / extrahelles Glas / Verre extra clair
■ Vetro fumé / smoked glass / Rauchglas / verre fumé

- Madia in vetro con piedi H. 20cm nella stessa finitura. Cassetti optional.
- Glass sideboard with feet h20cm. Optional drawers.
- Sideboard aus Glas mit Füßen H20cm. Optionale Schubladen.
- Sideboard en verre avec pieds h20cm. Tiroirs optionnels.

Liber cassetto						
design Luca Papini 2013/2019	C1 19 x 40 x h 25		0,03	15	2,5	● 270 ●● 290 ●●● 310 ●●●● 450
	C2 25 x 40 x h 19		0,03	15	2,5	● 280 ●● 300 ●●● 320 ●●●● 460
	C3 45 x 40 x h 19		0,06	15	4,5	● 330 ●● 340 ●●● 350 ●●●● 490

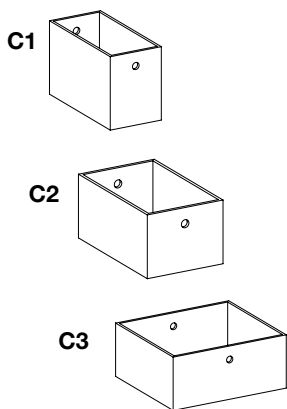

- Cassetto in legno laccato in finitura bianco opaco con foro bifacciale.
- Drawer in matt white lacquered wood with double sided opening.
- Schublade aus Holz matt weiß lackiert mit beidseitiger Öffnung.
- Tiroir en bois laqué mat blanc avec trou biface.

- Cassetto in legno laccato in finitura RAL opaco con foro bifacciale
- Drawer in matt RAL lacquered wood with double sided opening.
- Schublade aus Holz matt RAL lackiert mit beidseitiger Öffnung.
- Tiroir en bois laqué mat RAL avec trou biface.

- Cassetto in legno SIBERIAN ASH, EUCALIPTO e Noce Canaletto con maniglia in pelle.
- Wooden drawer in SIBERIAN ASH, EUCALIPTO and Canaletto Walnut with leather knob.
- Holzschublade aus SIBERIAN ASH, EUCALIPTO und Canaletto Walnuß mit Ledergriff.
- Tiroir en bois SIBERIAN ASH, EUCALIPTO et Noyer Canaletto avec pommeau en cuir.

- Cassetto in cuoio testa di moro con una maniglia.
- Drawer in dark leather with one handle.
- Schublade aus dunklem Leder mit einem Griff.
- Tiroir en cuir Tête-De-Maure avec un pommeau.

	I E D F	dimensioni dimension abmessungen dimension	spessore thickness stärke épaisseur	volume volume volumen volume	carico ammesso admitted load tragfähigkeit charge admise	peso weight gewicht poids	prezzo price preis prix
		cm	mm	m3	kg	kg	euro
Liber 100 design Luca Papini 2022	SX	100 x 39 x h 200	10 / 12	1,32	15*	159	3.480 <input type="checkbox"/> 3.760 <input checked="" type="checkbox"/> 3.950
	DX	100 x 39 x h 200	10 / 12	1,32	15*	159	3.480 <input type="checkbox"/> 3.760 <input checked="" type="checkbox"/> 3.950
	SX	100 x 39 x h 240	10 / 12	1,58	15*	191	4.180 <input type="checkbox"/> 4.550 <input checked="" type="checkbox"/> 4.780
	DX	100 x 39 x h 240	10 / 12	1,58	15*	191	4.180 <input type="checkbox"/> 4.550 <input checked="" type="checkbox"/> 4.780

H 200 SX

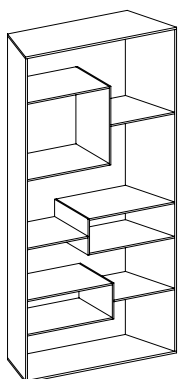

H 200 DX

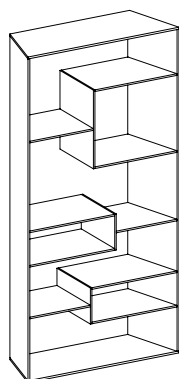

H 240 SX

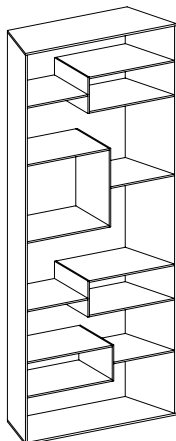

H 240 DX

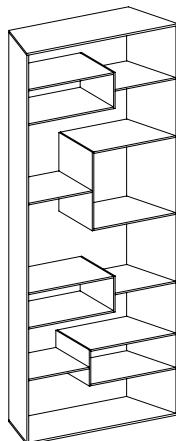

Optional CONTENITORE ANTA BATTENTE con maniglia in pelle
 optional HINGE DOOR STORAGE UNIT with leather handle
 optional DREHFLÜGELTÜR ELEMENT mit Ledergriff
 optionel RECIPIENT PORTE A BATTANT avec poignée en cuir

* ogni ripiano / on each shelf / auf jedem Bord / pour chaque étagère

- Vetro extrachiaro / extra clear glass / extrahelles Glas / verre extra clair
 Vetro fumé / smoked glass / Rauchglas / verre fumé

Specificare sempre se versione SX o DX
Always specify left or right version
Immer Version links oder rechts angeben
Toujours spécifier version gauche ou droite

- Libreria o espositore in vetro trasparente, extra chiaro o fumé con base a specchio e piedini regolabili. I fianchi inclinati permettono di realizzare composizioni curvilinee o lineari. Attrezzabile con contenitore in legno anta battente.
- Bookcase or showcase in transparent, extra clear or smoked glass with mirrored base and adjustable feet. The inclined sides allow to create curvilinear or linear compositions. It can be equipped with wooden storage unit with hinge door.
- Bücherregal oder Regal aus transparentem, extrahellem Glas oder Rauchglas mit verspiegeltem Boden und regulierbaren Füßen. Die schrägen Seiten erlauben sowohl krummlinige sowie lineare Kompositionen herzustellen. Es kann mit Holzelement mit Drehflügeltür ausgestattet werden.
- Bibliothèque ou présentoir en verre transparent, extra clair ou fumé avec base en miroir et pieds réglables. Le cotés inclinés permettent de réaliser des compositions curvilignes ou linéaires. Il peut être équipé avec récipient en bois avec porte a battant.

	I E D F	dimensioni dimension abmessungen dimension	spessore thickness stärke épaisseur	volume volume volumen volume	carico ammesso admitted load tragfähigkeit charge admise	peso weight gewicht poids	prezzo price preis prix
		cm	mm	m3	kg	kg	euro
Liber 100 Optional design Luca Papini 2022	LOC	54 x 39 x h 46		0,18		16	780
	LOL	54 x 39 x h 46		0,18		16	790

LOC

anta lato corto / door short side / Tür kurze Seite / porte coté court

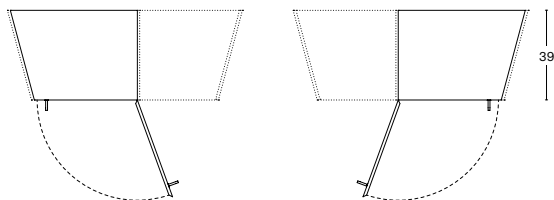
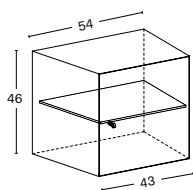

LOL

Anta lato lungo / door long side / Tür lange Seite / porte coté long

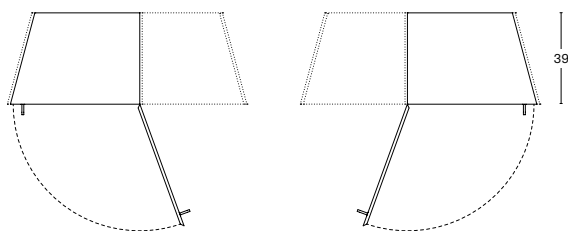
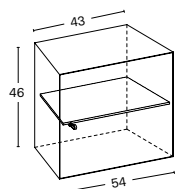

CONTENITORE ANTA BATTENTE
HINGE DOOR STORAGE UNIT
DREHFLÜGELTÜR ELEMENT
RECIPIENT PORTE A BATTANT

Specificare la finitura in legno SIBERIAN ASH o EUCALIPTO
Always specify wood finish SIBERIAN ASH o EUCALIPTO
Immer Holzausführung angeben SIBERIAN ASH oder EUCALIPTO
Toujours spécifier finition bois SIBERIAN ASH ou EUCALPITO

- Contenitore in legno SIBERIAN ASH o EUCALIPTO con anta battente a chiusura ammortizzata e maniglia in pelle.
Ripiano interno in vetro extra chiaro.
- Storage unit in wood SIBERIAN ASH or EUCALIPTO with soft closure hinge door and leather handle.
Extra clear glass internal shelf.
- Holzelement aus SIBERIAN ASH oder EUCALIPTO mit Drehflügeltür mit gedämpfter Schließung und Ledergriff.
Inneres Fach aus extrahellem Glas.
- Récipient en bois SIBERIAN ASH ou EUCALIPTO avec porte à battante avec fermeture amortie et poignée en cuir.
Etagère intérieur en verre extra clair.

	I E D F	dimensioni dimension abmessungen dimension	spessore thickness stärke épaisseur	volume volume volumen volume	carico ammesso admitted load tragfähigkeit charge admise	peso weight gewicht poids	prezzo price preis prix
		cm	mm	m3	kg	kg	euro
Liber 60 design Luca Papini 2022	SX	60 x 39 x h 200	10 / 12	0,81	15*	121	2.960 □ 3.240 ■ 3.410
	DX	60 x 39 x h 200	10 / 12	0,81	15*	121	2.960 □ 3.240 ■ 3.410
	SX	60 x 39 x h 240	10 / 12	0,97	15*	173	3.590 □ 3.920 ■ 4.130
	DX	60 x 39 x h 240	10 / 12	0,97	15*	173	3.590 □ 3.920 ■ 4.130

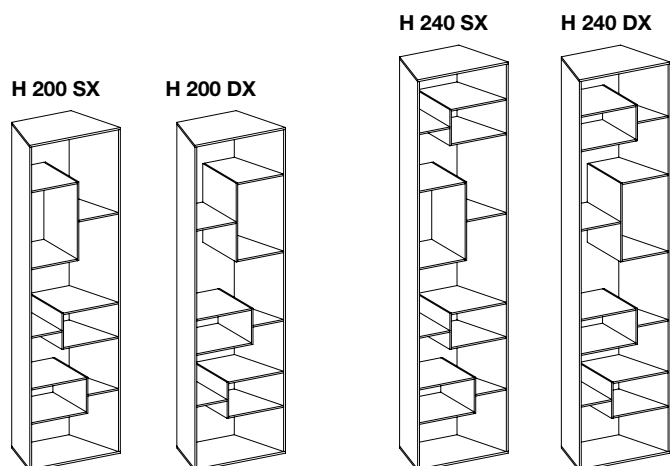

* ogni ripiano / on each shelf / auf jedem Bord / pour chaque étagère

- Vetro extrachiaro / extra clear glass / extrahelles Glas / verre extra clair
 ■ Vetro fumé / smoked glass / Rauchglas / verre fumé

Specificare sempre se versione SX o DX
Always specify left or right version
Immer Version links oder rechts angeben
Toujours spécifier version gauche ou droite

- Libreria o espositore in vetro trasparente, extra chiaro o fumé con base a specchio e piedini regolabili. I fianchi inclinati permettono di realizzare composizioni curvilinee o lineari.
- Bookcase or showcase in transparent, extra clear or smoked glass with mirrored base and adjustable feet. The inclined sides allow to create curvilinear or linear compositions.
- Bücherregal oder Regal aus transparentem, extrahellem Glas oder Rauchglas mit verspiegeltem Boden und regulierbaren Füßen. Die schrägen Seiten erlauben sowohl krummlinige sowie lineare Kompositionen herzustellen.
- Bibliothèque ou présentoir en verre transparent, extra clair ou fumé avec base en miroir et pieds réglables. Le cotés inclinés permettent de réaliser des compositions curvilignes ou linéaires.

Esempi di composizioni / Examples of compositions
Kompositionbeispiele / Examples de composition

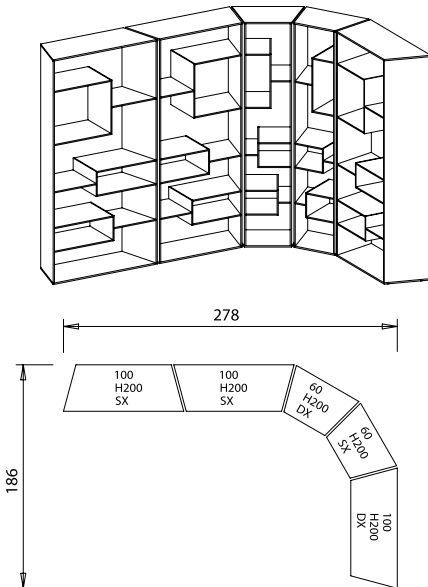

Comp. 1
278 x 186 x h 200
2 x 100 h 200 sx + 1 x 100 h 200 dx
1 x 60 h 200 dx + 1 x 60 h 200 sx
tot. ■ **16.360**
tot. □ **17.760**
tot. ■ **18.670**

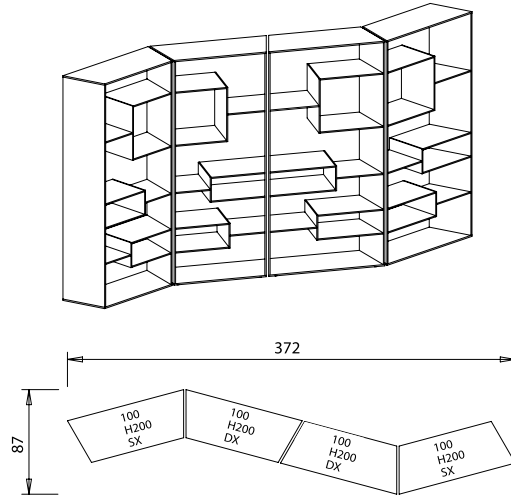

Comp. 2
372 x 87 x h 200
2 x 100 h 200 sx + 2 x 100 h 200 dx
tot. ■ **13.920**
tot. □ **15.040**
tot. ■ **15.800**

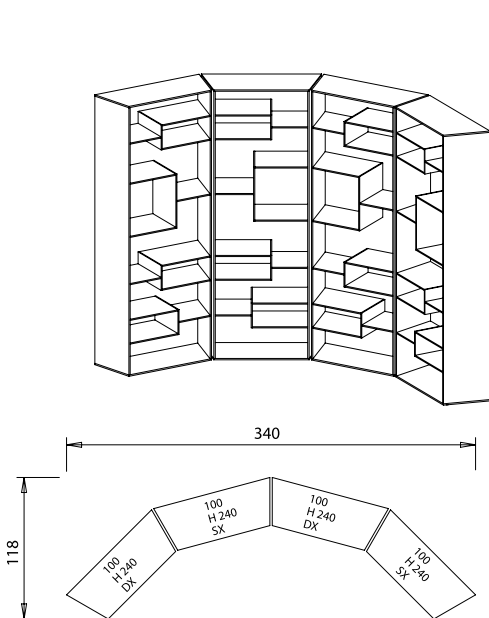

Comp. 3
340 x 118 x h 240
2 x 100 h 240 dx + 2 x 100 h 240 sx
tot. ■ **16.720**
tot. □ **18.200**
tot. ■ **19.120**

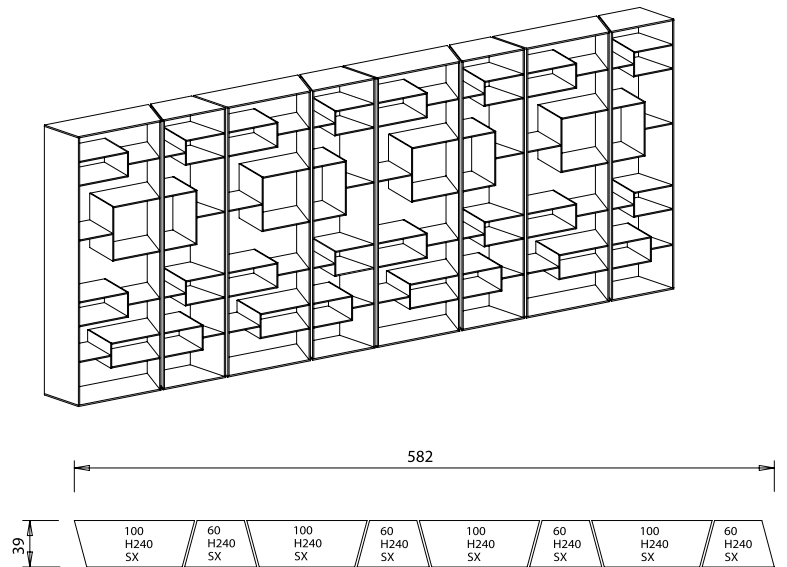

Comp. 4
582 x 39 x h 240
4 x 100 h 240 sx + 4 x 60 h 240 sx
tot. ■ **31.080**
tot. □ **33.880**
tot. ■ **35.640**

- Vetro extrachiaro / extra clear glass / extrahelles Glas / verre extra clair
- Vetro fumé / smoked glass / Rauchglas / verre fumé

	I E D F	dimensioni dimension abmessungen dimension	spessore thickness stärke épaisseur	volume volume volumen volume	carico ammesso admitted load tragfähigkeit charge admise	peso weight gewicht poids	prezzo price preis prix
		cm	mm	m3	kg	kg	euro

Livingstone

design Giulio Mancini 2006/2010

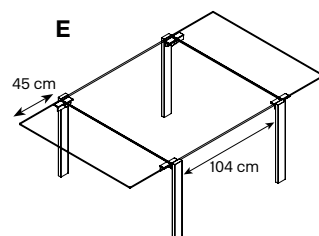
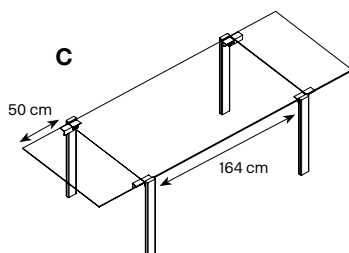
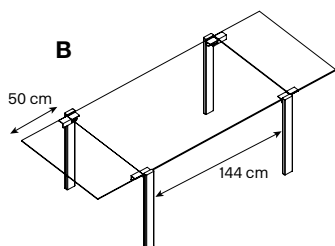
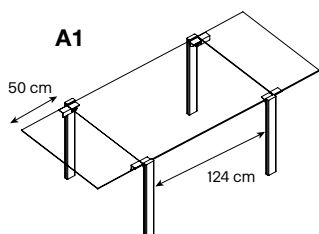
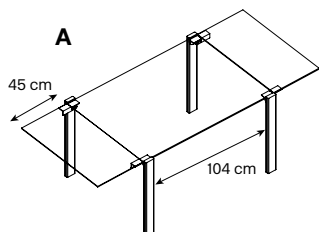

	120/210 x 90 x h 74	15 / 10	0,45	*170 / **40	100	● 3.080 □ 3.190
A						
	140/240 x 90 x h 74	15 / 10	0,47	*170 / **40	106	● 3.200 □ 3.330
A1						
	160/260 x 90 x h 74	15 / 10	0,48	*170 / **40	108	● 3.280 □ 3.440
B						
	180/280 x 90 x h 74	15 / 10	0,34	*170 / **40	115	● 3.460 □ 3.600
C						
	120/210 x 120 x h 74	15 / 10	0,34	*170 / **40	118	● 3.440 □ 3.580
E						

Maggiorazione per gambe in finitura: **ORO, RAME SPAZZOLATO, BRONZO SPAZZOLATO E CANNA DI FUCILE.** 220
 Surcharge for legs finishing in: **BRUSHED COPPER, BRUSHED BRONZE, GUNMETAL OR GOLD.**
 Aufpreis für Beine in Ausführung: **GEBÜRSTETES KUPFER, GEBÜRSTETE BRONZE, GUNMETAL ODER GOLD.**
 Surcôt pour pieds en finition: **CUIVRE BROSSE, BRONZE BROSSE, GUNMETAL OU OR.**

Maggiorazione per gambe rivestite in **CUOIO NATURALE O TESTA DI MORO.** 470
 Supplement for legs covered with **NATURAL OR DARK LEATHER.**
 Aufpreis für Beine mit **NATURLEDER ODER DUNKLEM LEDER UBERZOGEN.**
 Augmentation pieds recouverts en **CUIR NATUREL OU TETE-DE-MAURE.**

- Piano trasparente con allunghi trasparenti / transparent glass top with transparent extension leaves / Glasplatte transparent mit transparenten Verlängerungsplatten / plateau en verre transparent avec rallonges transparent
- Piano extrachiaro con allunghi extrachiaro / extra clear glass top and extra clear extension leaves / Glasplatte extrahell mit extrahellen Verlängerungsplatten / plateau en verre extra clair avec rallonges extra clairs

SPECIFICARE SEMPRE FINITURA GAMBE / ALWAYS SPECIFY LEGS FINISHING.
IMMER DIE AUSFÜHRUNG DER BEINE ANGEBEN / SPECIFIEZ TOUJOURS LA FINITION DES PIEDS.

* per tavolo/for table/für den Tisch/pour table ** per allungo/for extension/für Verlängerungsstück/pour allonge

- Tavolo allungabile in vetro temprato. Piano in vetro: trasparente o extrachiaro.
Gambe in metallo cromato, CROMATO OPACO, verniciate opaco bianche o nere.
- Extending table in tempered glass. Glass top: transparent or extraclear.
Legs in chrome, MATT CHROME, black or white matt lacquered.
- Hoher verlängerbarer Tisch aus Sicherheitsglas. Tischplatte: transparent, extrahell.
Beine verchromt, CHROM MATT, schwarz oder weiß matt lackiert.
- Table haute avec rallonges en verre trempé. Plateau: transparent, extra claire.
Pieds chromés, CHROME OPAQUE, laqués noir ou blanc opaque.

	I E D F	dimensioni dimension abmessungen dimension	spessore thickness stärke épaisseur	volume volume volumen volume	carico ammesso admitted load tragfähigkeit charge admise	peso weight gewicht poids	prezzo price preis prix
		cm	mm	m3	kg	kg	euro

Livingstone wood leg

design Giulio Mancini 2006/ 2014

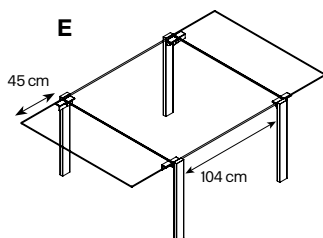
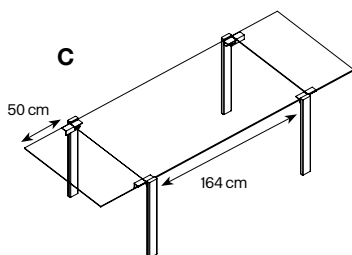
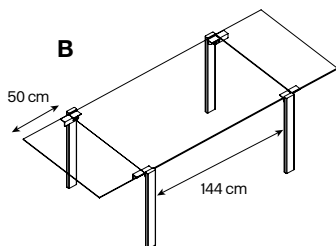
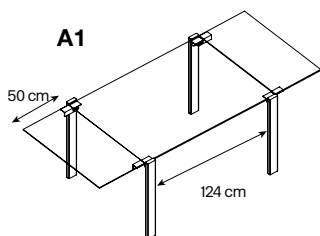
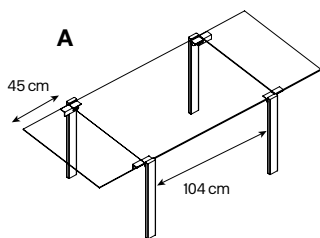

120/210 x 90 x h 74	15 / 10	0,45	*170 / **40	100	● 3.300 □ 3.410
A					
140/240 x 90 x h 74	15 / 10	0,47	*170 / **40	106	● 3.420 □ 3.550
A1					
160/260 x 90 x h 74	15 / 10	0,48	*170 / **40	108	● 3.500 □ 3.660
B					
180/280 x 90 x h 74	15 / 10	0,34	*170 / **40	115	● 3.680 □ 3.820
C					
120/210 x 120 x h 74	15 / 10	0,34	*170 / **40	118	● 3.660 □ 3.800
E					

- Piano trasparente con allunghi trasparenti / transparent glass top with transparent extension leaves / Glasplatte transparent mit transparenten Verlängerungsplatten / plateau en verre transparent avec rallonges transparents
- Piano extrachiaro con allunghi extrachiaro / extra clear glass top and extra clear extension leaves / Glasplatte extrahell mit extrahellen Verlängerungsplatten / plateau en verre extra clair avec rallonges extra clairs

**SPECIFICARE SEMPRE FINITURA GAMBE / ALWAYS SPECIFY LEGS FINISHING.
IMMER DIE AUSFÜHRUNG DER BEINE ANGEBEN / SPECIFIEZ TOUJOURS LA FINITION DES PIEDS.**

* per tavolo/for table/für den Tisch/pour table ** per allungo/for extension/für Verlängerungsstück/pour allonge

- Tavolo allungabile in vetro temperato. Piano in vetro: trasparente o extrachiaro.
- **Gambe in legno noce canaletto, rovere, wengè, Siberian Ash oppure Eucalipto.**
- Extending table in tempered glass. Glass top: transparent or extra clear.
- **Legs in canaletto walnut, oak, wengé, Siberian ash or Eucalipto.**
- Hoher verlängerbarer Tisch aus Sicherheitsglas. Tischplatte: transparent, extrahell.
- **Beine aus Walnuß Canaletto, Eiche, wengé, Siberian Ash or Eucalipto.**
- Table haute avec rallonges en verre trempé. Plateau: transparent, extra clair.
- **Pieds en noyer canaletto, rouvre, wengé, Siberian Ash ou Eucalipto.**

	I E D F	dimensioni dimension abmessungen dimension	spessore thickness stärke épaisseur	volume volume volumen volume	carico ammesso admitted load tragfähigkeit charge admise	peso weight gewicht poids	prezzo price preis prix
		cm	mm	m3	kg	kg	euro

Livingstone Dark

design Giulio Mancini 2020

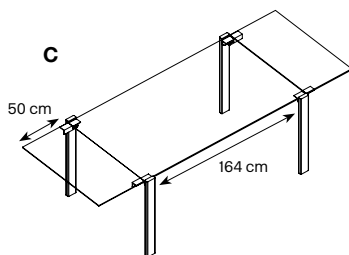
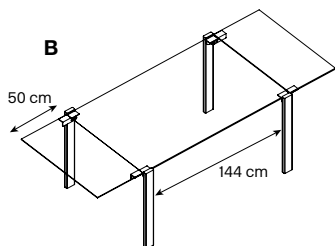
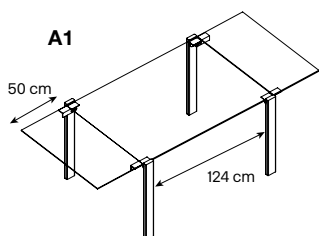
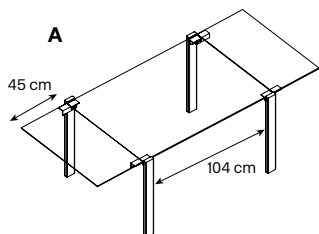

A 120/210x90xh74	10+6 / 10	0,45	* 170 / ** 40	110	■ 3.450 ■ 3.460
A1 140/240x90xh74	10+6 / 10	0,47	* 170 / ** 40	116	■ 3.580 ■ 3.590
B 160/260x90xh74	10+6 / 10	0,48	* 170 / ** 40	119	■ 3.660 ■ 3.690
C 180/280x90xh74	10+6 / 10	0,5	* 170 / ** 40	129	■ 3.780 ■ 3.820

Maggiorazione per gambe in finitura:

ORO, RAME SPAZZOLATO O BRONZO SPAZZOLATO oppure **CANNA DI FUCILE LUCIDO**

220

Surcharge for legs finishing in:

GOLD, BRUSHED COPPER OR BRUSHED BRONZE, or GUNMETAL POLISHED

Aupreis für Beine in Ausführung:

GOLD, KUPFER GEBÜRSTET, BRONZE GEBÜRSTET oder GUNMETAL GLÄNZEND

Augmentation pieds en finition:

OR, CUIVRE BROSSE, BRONZE BROSSE, ou GUNMETAL BRILLANT

Maggiorazione per gambe in LEGNO finitura:

NOCE CANALETTO, ROVERE, WENGÉ, SIBERIAN ASH oppure **EUCALIPTO**

220

Surcharge for legs in WOOD finishing:

WALNUT CANALETTO, OAK, WENGE, SIBERIAN ASH or EUCALIPTO

Aufpreis für Beine aus HOLZ, Ausführung:

WALNUS CANALETTO, EICHE, WENGE, SIBERIAN ASH oder EUCALIPTO

Augmentation pour pieds en BOIS, finition:

NOYER CANALETTO, ROUVRE, WENGÉ, SIBERIAN ASH ou EUCALIPTO

Maggiorazione per gambe rivestite in **CUOIO NATURALE** oppure **TESTA DI MORO**

Supplement for legs covered with **NATURAL** or **DARK LEATHER**

Aufpreis für Beine mit **NATURLEDER** oder **DUNKLEM LEDER ÜBERZOGEN**

Augmentation pieds recouverts en **CUIR NATUREL** ou **TETE-DE-MAURE**

470

- Vetro Fumè / smoked glass / Rauchglas / verre fumé
- Vetro Bronzo / bronze glass / Glas Bronze / verre bronze

Specificare sempre finitura del vetro / Always specify glass finish

Immer Glasausführung angeben / Spécifier toujours la finition du verre

Specificare sempre finitura gambe / Always specify legs finishing.

Immer die Ausführung der Beine angeben / Spécifier toujours la finition des pieds.

* per tavolo / for table / für den Tisch / pour table ** per allungo / for extension / für Verlängerungsstück / pour allonge

- Tavolo alto allungabile in vetro stratificato e temperato. Piano in vetro fumè o bronzo, gambe in metallo cromato, cromato opaco, verniciato opaco bianco o nero.
- Extending table in stratified and tempered glass. Top in smoked or bronze glass, metal legs in chrome, matt chrome, matt black or white lacquered.
- Verlängerbarer Tisch in gehärtetem Schichtglas. Tischplatte aus Rauchglas oder Bronze Glas, Metallbeine in Chrom, Chrom matt, matt schwarz oder weiß lackiert.
- Table avec rallonges en verre stratifié et trempé. Plateau en verre fumé ou bronze, pieds en métal chromé, chromé mat, laqués noir ou blanc mat.

	I E D F	dimensioni dimension abmessungen dimension	spessore thickness stärke épaisseur	volume volume volumen volume	carico ammesso admitted load tragfähigkeit charge admise	peso weight gewicht poids	prezzo price preis prix
		cm	mm	m3	kg	kg	euro

Livingstand Dark

design Giulio Mancini 2020

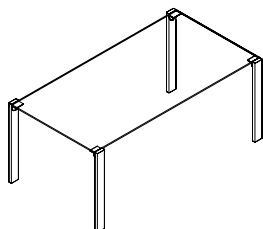

120 x 90 x h 74	10+6	0,12	* 170	70	■ 2.220 ■ 2.230
140 x 90 x h 74	10+6	0,21	* 170	78	■ 2.410 ■ 2.430
160 x 90 x h 74	10+6	0,23	* 170	87	■ 2.510 ■ 2.540
180 x 90 x h 74	10+6	0,25	* 170	96	■ 2.660 ■ 2.700

Maggiorazione per gambe in finitura:

ORO, RAME SPAZZOLATO O BRONZO SPAZZOLATO oppure **CANNA DI FUCILE LUCIDO**

220

Surcharge for legs finishing in:

GOLD, BRUSHED COPPER OR BRUSHED BRONZE, or GUNMETAL POLISHED

Aupreis für Beine in Ausführung:

GOLD, KUPFER GEBÜRSTET, BRONZE GEBÜRSTET oder **GUNMETAL GLÄNZEND**

Augmentation pieds en finition:

OR, CUIVRE BROUSSE, BRONZE BROUSSE, ou GUNMETAL BRILLANT

Maggiorazione per gambe in LEGNO finitura:

NOCE CANALETTO, ROVERE, WENGÉ, SIBERIAN ASH oppure **EUCALIPTO**

220

Surcharge for legs in WOOD finishing:

WALNUT CANALETTO, OAK, WENGE, SIBERIAN ASH or **EUCALIPTO**

Aufpreis für Beine aus HOLZ, Ausführung:

WALNUS CANALETTO, EICHE, WENGE, SIBERIAN ASH oder **EUCALIPTO**

Augmentation pour pieds en BOIS, finition:

NOYER CANALETTO, ROUVRE, WENGÉ, SIBERIAN ASH ou **EUCALIPTO**

Maggiorazione per gambe rivestite in **CUOIO NATURALE** oppure **TESTA DI MORO**

Supplement for legs covered with **NATURAL** or **DARK LEATHER**

Aufpreis für Beine mit **NATURLEDER** oder **DUNKLEM LEDER ÜBERZOGEN**

Augmentation pieds recouverts en **CUIR NATUREL** ou **TETE-DE-MAURE**

470

- Vetro Fumè / smoked glass / Rauchglas / verre fumé
- Vetro Bronzo / bronze glass / Glas Bronze / verre bronze

Specificare sempre finitura del vetro / Always specify glass finish

Immer Glasausführung angeben / Spécifiez toujours la finition du verre

Specificare sempre finitura gambe / Always specify legs finishing.

Immer die Ausführung der Beine angeben / Spécifiez toujours la finition des pieds.

* per tavolo / for table / für den Tisch / pour table

- Tavolo alto in vetro stratificato e temperato. Piano in vetro fumè o bronzo, gambe in metallo cromato, cromato opaco, verniciato opaco bianco o nero.
- Table in stratified and tempered glass. Top in smoked or bronze glass, metal legs in chrome, matt chrome, matt black or white lacquered.
- Tisch in gehärtetem Schichtglas. Tischplatte aus Rauchglas oder Bronze Glas, Metallbeine in Chrom, Chrom matt, matt schwarz oder weiß lackiert.
- Table en verre stratifié et trempé. Plateau en verre fumé ou bronze, pieds en métal chromé, chromé mat, laqués noir ou blanc mat.

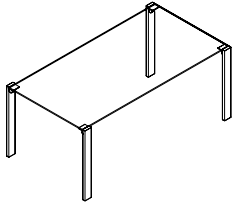
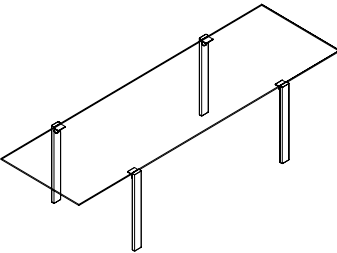
	I E D F	dimensioni dimension abmessungen dimension	spessore thickness stärke épaisseur	volume volume volumen volume	carico ammesso admitted load tragfähigkeit charge admise	peso weight gewicht poids	prezzo price preis prix
		cm	mm	m3	kg	kg	euro
Livingstand design Giulio Mancini 2006/2011 		120 x 90 x h 74	15	0,12	170	70	● 1.970 □ 2.170
		140 x 90 x h 74	15	0,21	170	78	● 2.030 □ 2.260
		160 x 90 x h 74	15	0,23	170	87	● 2.060 □ 2.350
		180 x 90 x h 74	15	0,23	170	87	● 2.140 □ 2.490
		200 x 100 x h 74	15	0,12	170	114	● 2.340 □ 2.770
		220 x 100 x h 74	15	0,33	170	124	● 2.460 □ 2.920
		240 x 100 x h 74	15	0,36	170	134	● 2.530 □ 3.060
		260 x 100 x h 74	15	0,38	170	144	● 2.630 □ 3.230
		280 x 100 x h 74	15	0,41	170	154	● 2.760 □ 3.390

Maggiorazione per gambe in finitura: **RAME SPAZZOLATO, BRONZO SPAZZOLATO, CANNA DI FUCILE E ORO.** 220
 Surcharge for legs finishing in: **BRUSHED COPPER, BRUSHED BRONZE, GUNMETAL OR GOLD.**
 Aufpreis für Beine in Ausführung: **GEBÜRSTETES KUPFER, GEBÜRSTETE BRONZE, GUNMETAL ODER GOLD.**
 Surcoût pour pieds en finition: **CUIVRE BROSSE, BRONZE BROSSE, GUNMETAL OU OR.**

Maggiorazione per gambe rivestite in **CUOIO NATURALE O TESTA DI MORO** 470
 Supplement for legs covered with **NATURAL OR DARK LEATHER.**
 Aufpreis für Beine mit **NATURLEDER ODER DUNKLEM LEDER ÜBERZOGEN.**
 Augmentation pieds recouverts en **CUIR NATUREL OU TETE-DE-MAURE.**

- Piano trasparente / transparent glass top / Glasplatte transparent / Plateau en verre transparent
- Piano extrachiaro / extra clear glass top / Glasplatte extrahell / Plateau en verre extra clair

SPECIFICARE SEMPRE FINITURA GAMBE. / ALWAYS SPECIFY LEGS FINISHING.
IMMER DIE AUSFÜHRUNG DER BEINE ANGEBEN. / SPECIFIEZ TOUJOURS LA FINITION DES PIEDS.

- Tavolo in vetro temprato trasparente o extrachiaro. Gambe in metallo cromato, CROMATO OPACO, verniciate opaco bianche o nere.
- Dining table in tempered transparent or extra clear glass. Legs in chrome, MATT CHROME, black or white matt lacquered.
- Eßtisch aus Sicherheitsglas transparent oder extrahell. Beine verchromt, CHROM MATT, schwarz oder weiß matt lackiert.
- Table haut en verre trempé transparent ou extra clair. Pieds chromés, CHROME OPAQUE, laqués noir ou blanc opaque.

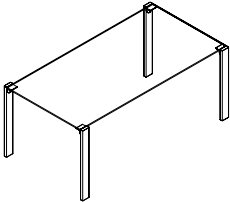
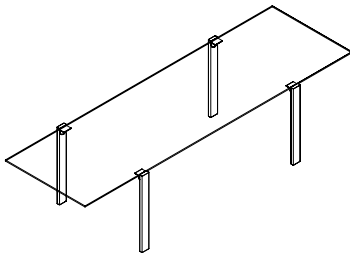
	I E D F	dimensioni dimension abmessungen dimension	spessore thickness stärke épaisseur	volume volume volumen volume	carico ammesso admitted load tragfähigkeit charge admise	peso weight gewicht poids	prezzo price preis prix
		cm	mm	m3	kg	kg	euro
Livingstand wood leg design Giulio Mancini 2000/2014 		120 x 90 x h 74	15	0,12	170	70	● 2.190 □ 2.390
		140 x 90 x h 74	15	0,21	170	78	● 2.250 □ 2.480
		160 x 90 x h 74	15	0,23	170	87	● 2.280 □ 2.570
		180 x 90 x h 74	15	0,23	170	87	● 2.360 □ 2.710
		200 x 100 x h 74	15	0,12	170	114	● 2.560 □ 2.990
		220 x 100 x h 74	15	0,33	170	124	● 2.680 □ 3.140
		240 x 100 x h 74	15	0,36	170	134	● 2.750 □ 3.280
		260 x 100 x h 74	15	0,38	170	144	● 2.850 □ 3.450
		280 x 100 x h 74	15	0,41	170	154	● 2.980 □ 3.610

- Piano trasparente / transparent glass top / Glasplatte transparent / Plateau en verre transparent
- Piano extrachiaro / extra clear glass top / Glasplatte extrahell / Plateau en verre extra clair

**SPECIFICARE SEMPRE FINITURA GAMBE / ALWAYS SPECIFY LEGS FINISHING.
 IMMER DIE AUSFÜHRUNG DER BEINE ANGEBEN / SPECIFIEZ TOUJOURS LA FINITION DES PIEDS.**

- Tavolo in vetro temprato trasparente o extrachiaro.
Gambe in legno noce canaletto, rovere, wengè, Siberian Ash oppure Eucalipto.
- Dining table tempered, transparent or extra clear glass.
Legs in canaletto walnut, oak, wengè, Siberian ash or Eucalipto.
- Eßtisch aus Sicherheitsglas transparent oder extrahell.
Beine aus Walnuß Canaletto, Eiche, wengè, Siberian Ash or Eucalipto.
- Table haut en verre trempé transparent ou extra clair.
Pieds en noyer canaletto, rouvre, wengè, Siberian Ash ou Eucalipto.

	I E D F	dimensioni dimension abmessungen dimension	spessore thickness stärke épaisseur	volume volume volumen volume	carico ammesso admitted load tragfähigkeit charge admise	peso weight gewicht poids	prezzo price preis prix
		cm	mm	m3	kg	kg	euro

Major

design Bellavista & Piccini 2021

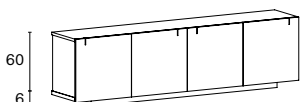

A1

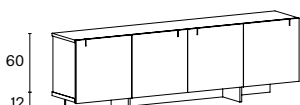

A2

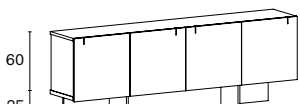

A3

A1	240 x 45x h 66	20/10	0,677	80	177	● 6.640 ● 6.720
A2	240 x 45x h 72	20/10	0,756	80	195	■ □ 6.960 ■ 7.280 ■ □ 7.040 ■ 7.360
A3	240 x 45x h 85	20/10	0,925	80	216	■ □ 7.260 ■ 7.710 ■ □ 7.340 ■ 7.790

R1
Optional ripiano interno in vetro, comunicare sempre la posizione del ripiano.
Optional internal glass shelf, always indicate position of shelf.
Optionale interner Glasboden, immer Position des Bodens angeben.
Optionnel étagère intérieure en verre, toujours indiquer position de l'étagère.

H1
Optional separatore in finitura laccato nero opaco con ripiani regolabili in altezza
Optional partition in matt black lacquer with height adjustable shelves
Optionale Trennwand matt schwarz lackiert mit höhenverstellbaren Fächern
Option cloison laqué noir mat avec étagères réglables en hauteur

Specificare la finitura del legno SIBERIAN ASH oppure EUCALIPTO
Always specify wood finish SIBERIAN ASH or EUCALIPTO
Immer Holzführung angeben SIBERIAN ASH oder EUCALIPTO
Indiquer toujours finition bois SIBERIAN ASH ou EUCALIPTO

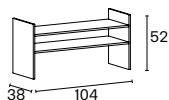

H1

- Struttura vetro fumè e zoccolo laccato nero / smoked glass structure and black lacquered plinth
Struktur aus Rauchglas und schwarz lackierter Sockel / structure en verre fumé et socle laqué noir
- Struttura vetro bronzo e zoccolo laccato nero / bronze glass structure and black lacquered plinth
Struktur aus Bronze Glas und schwarz lackierter Sockel / structure en verre bronze et socle laqué noir
- □ Struttura vetro fumè e basamento vetro extrachiaro / smoked glass structure and base in extra clear glass
Struktur aus Rauchglas und Gestell aus extrahellem Glas / structure en verre fumé et piètement en verre extra clair
- Struttura e basamento vetro fumè / smoked glass structure and base / Struktur und Gestell aus Rauchglas
structur et piètement en verre fumé
- □ Struttura vetro bronzo e basamento vetro extrachiaro / bronze glass structure and base in extra clear glass
Struktur aus Bronze Glas und Gestell aus extrahellem Glas / structure en verre bronze et piètement
en verre extra clair
- Struttura e basamento vetro bronzo / bronze glass structure and base / Struktur und Gestell aus Bronze
Glas / structure et piètement en verre bronze

- Madia a due vani e 4 ante scorrevoli apribili a 180° su sé stesse. Le ante sono dotate di maniglia in finitura canna di fucile lucido.
La struttura è in vetro fumè o bronzo; top, fondo e frontali in legno in venatura continua in finitura Eucalipto o Siberian Ash.

La madia può essere su zoccolo laccato nero o su basamento in vetro extrachiaro, fumè o bronzo di due altezze.
Optional un separatore interno in finitura laccato nero opaco con ripiani regolabili in altezza.

- Sideboard with 2 compartments and 4 sliding doors also opening at 180°.
The doors are provided with handles in polished gunmetal finish.

Structure is in smoked or bronze glass; top, bottom and frontal panels are in wood with continuous grain in Eucalipto or Siberian Ash finish. The sideboard can be with black lacquered plinth or with a base made of extra clear, smoked or bronze glass in 2 heights. Optional internal partition in matt black lacquer with height adjustable shelves.

- Anrichte mit 2 Abteilungen und 4 Schiebetüren die sich auch um 180° öffnen lassen. Die Türen sind mit Griffen aus glänzendem Gunmetal versehen. Die Struktur ist aus Rauchglas oder Bronze Glas; Top, Boden und Vorderseite sind aus Holz mit durchgehender Maserung in Ausführung Eucalipto oder Siberian Ash.

Die Anrichte kann auf schwarz lackiertem Sockel sein oder auf Gestell in extrahellem, Rauch- oder Bronze Glas in zwei verschiedenen Höhen. Optionale innere Trennwand matt schwarz lackiert mit höhenverstellbaren Fächern.

- Buffet avec 2 compartiments et 4 portes coulissant, qui s'ouvrent aussi à 180°. Les portes sont équipées avec des poignées en gunmetal brillant. La structure est en verre fumé ou bronze; top, fond et frontales sont en bois avec veinure continu en finition Eucalipto ou Siberian Ash. Le buffet peut être sur socle laqué noir ou sur piètement en verre extra clair, fumé ou bronze en deux hauteurs. Option cloison laqué noir mat avec étagères réglables en hauteur.

	I	dimensioni	spessore	volume	carico ammesso	peso	prezzo
	E	dimension	thickness	volume	admitted load	weight	price
	D	abmessungen	stärke	volumen	tragfähigkeit	gewicht	preis
	F	dimension	épaisseur	volume	charge admise	poids	prix
		cm	mm	m3	kg	kg	euro

Major

design Bellavista & Piccini 2021

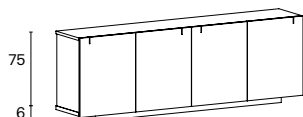

B1

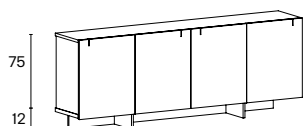

B2

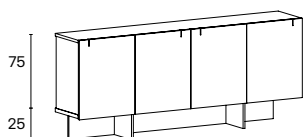

B3

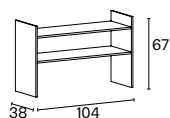

H2

B1	240 x 45x h 81	20/10	0,746	80	208	● 7.080 ● 7.210
B2	240 x 45x h 87	20/10	0,825	80	226	■ □ 7.430 ■ 7.750 ■ □ 7.560 ■ 7.880
B3	240 x 45x h 100	20/10	0,994	80	247	■ □ 7.730 ■ 8.180 ■ □ 7.860 ■ 8.310

R1

Optional ripiano interno in vetro, comunicare sempre la posizione del ripiano.
Optional internal glass shelf, always indicate position of shelf.
Optionale interner Glasboden, immer Position des Bodens angeben.
Optionnel étagère intérieure en verre, toujours indiquer position de l'étagère.

380

H2

Optional separatore in finitura laccato nero opaco con ripiani regolabili in altezza
Optional partition in matt black lacquer with height adjustable shelves
Optionale Trennwand matt schwarz lackiert mit höhenverstellbaren Fächern
Option cloison laqué noir mat avec étagères réglables en hauteur

660

Specificare la finitura del legno SIBERIAN ASH oppure EUCALIPTO

Always specify wood finish SIBERIAN ASH or EUCALIPTO

Immer Holzausführung angeben SIBERIAN ASH oder EUCALIPTO

Indiquer toujours finition bois SIBERIAN ASH ou EUCALIPTO

- Struttura vetro fumè e zoccolo laccato nero / smoked glass structure and black lacquered plinth
Struktur aus Rauchglas und schwarz lackierter Sockel / structure en verre fumé et socle laqué noir
- Struttura vetro bronzo e zoccolo laccato nero / bronze glass structure and black lacquered plinth
Struktur aus Bronze Glas und schwarz lackierter Sockel / structure en verre bronze et socle laqué noir
- □ Struttura vetro fumè e basamento vetro extrachiaro / smoked glass structure and base in extra clear glass
Struktur aus Rauchglas und Gestell aus extrahellem Glas / structure en verre fumé et piètement en verre extra clair
- Struttura e basamento vetro fumè / smoked glass structure and base / Struktur und Gestell aus Rauchglas
structur et piètement en verre fumé
- □ Struttura vetro bronzo e basamento vetro extrachiaro / bronze glass structure and base in extra clear glass
Struktur aus Bronze Glas und Gestell aus extrahellem Glas / structure en verre bronze et piètement
en verre extra clair
- Struttura e basamento vetro bronzo / bronze glass structure and base / Struktur und Gestell aus Bronze
Glas / structure et piètement en verre bronze

- Madia a due vani e 4 ante scorrevoli apribili a 180° su sé stesse. Le ante sono dotate di maniglia in finitura canna di fucile lucido.

La struttura è in vetro fumè o bronzo; top, fondo e frontali in legno in venatura continua in finitura Eucalipto o Siberian Ash.

La madia può essere su zoccolo laccato nero o su basamento in vetro extrachiaro, fumè o bronzo di due altezze.

Optional un separatore interno in finitura laccato nero opaco con ripiani regolabili in altezza.

- Sideboard with 2 compartments and 4 sliding doors also opening at 180°.

The doors are provided with handles in polished gunmetal finish.

Structure is in smoked or bronze glass; top, bottom and frontal panels are in wood with continuous grain in Eucalipto or Siberian Ash finish. The sideboard can be with black lacquered plinth or with a base made of extra clear, smoked or bronze glass in 2 heights. Optional internal partition in matt black lacquer with height adjustable shelves.

- Anrichte mit 2 Abteilungen und 4 Schiebetüren die sich auch um 180° öffnen lassen. Die Türen sind mit Griffen aus glänzendem Gunmetal versehen. Die Struktur ist aus Rauchglas oder Bronze Glas; Top, Boden und Vorderseite sind aus Holz mit durchgehender Maserung in Ausführung Eucalipto oder Siberian Ash.

- Die Anrichte kann auf schwarz lackiertem Sockel sein oder auf Gestell in extrahellem, Rauch- oder Bronze Glas in zwei verschiedenen Höhen. Optionale innere Trennwand matt schwarz lackiert mit höhenverstellbaren Fächern.

- Buffet avec 2 compartiments et 4 portes coulissant, qui s'ouvrent aussi à 180°. Les portes sont équipées avec des poignées en gunmetal brillant. La structure est en verre fumé ou bronze; top, fond et frontales sont en bois avec veinure continu en finition Eucalipto ou Siberian Ash. Le buffet peut être sur socle laqué noir ou sur piètement en verre extra clair, fumé ou bronze en deux hauteurs. Option cloison laqué noir mat avec étagères réglables en hauteur.

	I	dimensioni	spessore	volume	carico ammesso	peso	prezzo
	E	dimension	thickness	volume	admitted load	weight	price
	D	abmessungen	stärke	volumen	tragfähigkeit	gewicht	preis
	F	dimension	épaisseur	volume	charge admise	poids	prix
		cm	mm	m3	kg	kg	euro

Major

design Bellavista & Piccini 2021

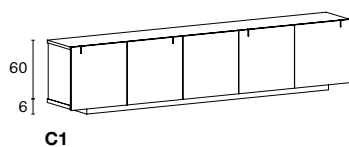

C1

C1	300 x 45x h 66	20/10	0,863	100	224	● 8.320 ● 8.430
C2	300 x 45x h 72	20/10	0,96	100	247	■ □ 8.650 ■ 9.080 ■ □ 8.760 ■ 9.190
C3	300 x 45x h 85	20/10	1,17	100	277	■ □ 9.020 ■ 9.610 ■ □ 9.130 ■ 9.720

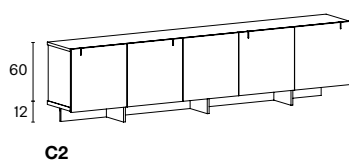

C2

R2
Optional ripiano interno in vetro per vani laterali, comunicare sempre la posizione del ripiano.
Optional internal glass shelf for lateral compartments, always indicate position of shelf.
Optionale Trennwand für seitliche Abteilungen matt schwarz lackiert mit höhenverstellbaren Fächern.
Optionnel étagère intérieure en verre pour compartiments latéraux, toujours indiquer position de l'étagère.

420

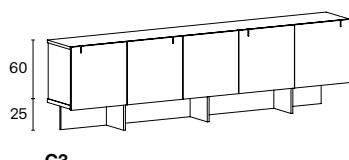

C3

H1
Optional separatore per vani laterali in finitura laccato nero opaco con ripiani regolabili in altezza
Optional partition for lateral compartments in matt black lacquer with height adjustable shelves
Optionale Trennwand für seitliche Abteilungen matt schwarz lackiert mit höhenverstellbaren Fächern.
Option cloison laqué noir pour compartiments latéraux avec étagères réglables en hauteur

620

Specificare la finitura del legno SIBERIAN ASH oppure EUCALIPTO
Always specify wood finish SIBERIAN ASH or EUCALIPTO
Immer Holzausführung angeben SIBERIAN ASH oder EUCALIPTO
Indiquer toujours finition bois SIBERIAN ASH ou EUCALIPTO

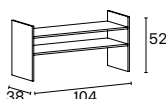

H1

- Struttura vetro fumé e zoccolo laccato nero / smoked glass structure and black lacquered plinth
Struktur aus Rauchglas und schwarz lackierter Sockel / structure en verre fumé et socle laqué noir
- Struttura vetro bronzo e zoccolo laccato nero / bronze glass structure and black lacquered plinth
Struktur aus Bronze Glas und schwarz lackierter Sockel / structure en verre bronze et socle laqué noir
- □ Struttura vetro fumé e basamento vetro extrachiaro / smoked glass structure and base in extra clear glass
Struktur aus Rauchglas und Gestell aus extrahellem Glas / structure en verre fumé et piètement en verre extra clair
- Struttura e basamento vetro fumé / smoked glass structure and base / Struktur und Gestell aus Rauchglas
structur et piètement en verre fumé
- □ Struttura vetro bronzo e basamento vetro extrachiaro / bronze glass structure and base in extra clear glass
Struktur aus Bronze Glas und Gestell aus extrahellem Glas / structure en verre bronze et piètement
en verre extra clair
- Struttura e basamento vetro bronzo / bronze glass structure and base / Struktur und Gestell aus Bronze
Glas / structure et piètement en verre bronze

- Madia a tre vani e 5 ante scorrevoli di cui 4 apribili a 180° su sé stesse. Le ante sono dotate di maniglia in finitura canna di fucile lucido. La struttura è in vetro fumé o bronzo; top, fondo e frontali in legno in venatura continua in finitura Eucalipto o Siberian Ash. La madia può essere su zoccolo laccato nero o su basamento in vetro extrachiaro, fumé o bronzo di due altezze.
Optional un separatore interno per i vani laterali in finitura laccato nero opaco con ripiani regolabili in altezza.
- Sideboard with 3 compartments and 5 sliding doors, 4 of which also opening at 180°.
The doors are provided with handles in polished gunmetal finish.
Structure is in smoked or bronze glass; top, bottom and frontal panels are in wood with continuous grain in Eucalipto or Siberian Ash finish. The sideboard can be with black lacquered plinth or with a base made of extra clear, smoked or bronze glass in 2 heights. Optional partition for lateral compartments in matt black lacquer with height adjustable shelves.
- Anrichte mit 3 Abteilungen und 5 Schiebetüren, von denen 4 sich auch um 180° öffnen lassen. Die Türen sind mit Griffen aus glänzendem Gunmetal versehen. Die Struktur ist aus Rauchglas oder Bronze Glas; Top, Boden und Vorderseite sind aus Holz mit durchgehender Maserung in Ausführung Eucalipto oder Siberian Ash.
Die Anrichte kann auf schwarz lackiertem Sockel sein oder auf Gestell in extrahellem, Rauch- oder Bronze Glas in zwei verschiedenen Höhen. Optionale Trennwand für seitliche Abteilungen matt schwarz lackiert mit höhenverstellbaren Fächern.
- Buffet avec 3 compartiments et 5 portes coulissant, desquels 4 s'ouvrent aussi à 180°. Les portes sont équipées avec des poignées en gunmetal brillant. La structure est en verre fumé ou bronze; top, fond et frontales sont en bois avec veinure continu en finition Eucalipto ou Siberian Ash. Le buffet peut être sur socle laqué noir ou sur piètement en verre extra clair, fumé ou bronze en deux hauteurs. Option cloison laqué noir pour compartiments latéraux avec étagères réglables en hauteur.

	I	dimensioni	spessore	volume	carico ammesso	peso	prezzo
	E	dimension	thickness	volume	admitted load	weight	price
	D	abmessungen	stärke	volumen	tragfähigkeit	gewicht	preis
	F	dimension	épaisseur	volume	charge admise	poids	prix
		cm	mm	m3	kg	kg	euro

Major

design Bellavista & Piccini 2021

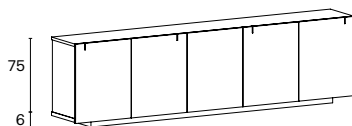

D1

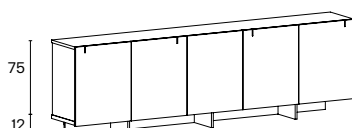

D2

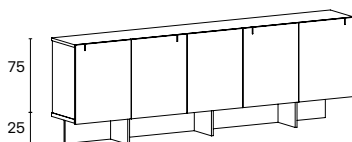

D3

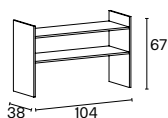

H2

D1	300 x 45x h 81	20/10	0,953	100	260	● 8.880 ● 9.040
D2	300 x 45x h 87	20/10	1,05	100	283	■ □ 9.220 ■ 9.650 ■ □ 9.380 ■ 9.810
D3	300 x 45x h 100	20/10	1,26	100	313	■ □ 9.580 ■ 10.170 ■ □ 9.740 ■ 10.330

R2
Optional ripiano interno in vetro per vani laterali, comunicare sempre la posizione del ripiano.
Optional internal glass shelf for lateral compartments, always indicate position of shelf.
Optionale interner Glasboden für Seitenräume, immer Position des Bodens angeben.
Optionnel étagère intérieure en verre pour compartiments latéraux, toujours indiquer position de l'étagère. **420**

H2
Optional separatore per vani laterali in finitura laccato nero opaco con ripiani regolabili in altezza
Optional partition for lateral compartments in matt black lacquer with height adjustable shelves
Optionale Trennwand für seitliche Abteilungen matt schwarz lackiert mit höhenverstellbaren Fächern.
Option cloison laqué noir pour compartiments latéraux avec étagères réglables en hauteur **660**

Specificare la finitura del legno SIBERIAN ASH oppure EUCALIPTO
Always specify wood finish SIBERIAN ASH or EUCALIPTO
Immer Holzausführung angeben SIBERIAN ASH oder EUCALIPTO
Indiquer toujours finition bois SIBERIAN ASH ou EUCALIPTO

- Struttura vetro fumè e zoccolo laccato nero / smoked glass structure and black lacquered plinth
Struktur aus Rauchglas und schwarz lackierter Sockel / structure en verre fumé et socle laqué noir
- Struttura vetro bronzo e zoccolo laccato nero / bronze glass structure and black lacquered plinth
Struktur aus Bronze Glas und schwarz lackierter Sockel / structure en verre bronze et socle laqué noir
- □ Struttura vetro fumè e basamento vetro extrachiaro / smoked glass structure and base in extra clear glass
Struktur aus Rauchglas und Gestell aus extrahellem Glas / structure en verre fumé et piètement en verre extra clair
- Struttura e basamento vetro fumè / smoked glass structure and base / Struktur und Gestell aus Rauchglas
structur et piètement en verre fumé
- □ Struttura vetro bronzo e basamento vetro extrachiaro / bronze glass structure and base in extra clear glass
Struktur aus Bronze Glas und Gestell aus extrahellem Glas / structure en verre bronze et piètement
en verre extra clair
- Struttura e basamento vetro bronzo / bronze glass structure and base / Struktur und Gestell aus Bronze
Glas / structure et piètement en verre bronze

- Madia a tre vani e 5 ante scorrevoli di cui 4 apribili a 180° su se stesse. Le ante sono dotate di maniglia in finitura canna di fucile lucido. La struttura è in vetro fumè o bronzo; top, fondo e frontali in legno in venatura continua in finitura Eucalipto o Siberian Ash. La madia può essere su zoccolo laccato nero o su basamento in vetro extra chiaro, fumè o bronzo di due altezze.
Optional un separatore interno per i vani laterali in finitura laccato nero opaco con ripiani regolabili in altezza.
- Sideboard with 3 compartments and 5 sliding doors, 4 of which also opening at 180°. The doors are provided with handles in polished gunmetal finish.
Structure is in smoked or bronze glass; top, bottom and frontal panels are in wood with continuous grain in Eucalipto or Siberian Ash finish. The sideboard can be with black lacquered plinth or with a base made of extra clear, smoked or bronze glass in 2 heights. Optional partition for lateral compartments in matt black lacquer with height adjustable shelves.
- Anrichte mit 3 Abteilungen und 5 Schiebetüren, von denen 4 sich auch um 180° öffnen lassen. Die Türen sind mit Griffen aus glänzendem Gunmetal versehen. Die Struktur ist aus Rauchglas oder Bronze Glas; Top, Boden und Vorderseite sind aus Holz mit durchgehender Maserung in Ausführung Eucalipto oder Siberian Ash.
Die Anrichte kann auf schwarz lackiertem Sockel sein oder auf Gestell in extrahellem, Rauch- oder Bronze Glas in zwei verschiedenen Höhen. Optionale Trennwand für seitliche Abteilungen matt schwarz lackiert mit höhenverstellbaren Fächern.
- Buffet avec 3 compartiments et 5 portes coulissantes, desquels 4 s'ouvrent aussi à 180°. Les portes sont équipées avec des poignées en gunmetal brillant. La structure est en verre fumé ou bronze; top, fond et frontales sont en bois avec veinure continue en finition Eucalipto ou Siberian Ash. Le buffet peut être sur socle laqué noir ou sur piètement en verre extra clair, fumé ou bronze en deux hauteurs. Option cloison laqué noir pour compartiments latéraux avec étagères réglables en hauteur.

	I E D F	dimensioni dimension abmessungen dimension	spessore thickness stärke épaisseur	volume volume volumen volume	carico ammesso admitted load tragfähigkeit charge admise	peso weight gewicht poids	prezzo price preis prix
		cm	mm	m3	kg	kg	euro

Marcell Consolle

design Massimo Castagna 2021

B	150 x 45 x h 75	12	0,792	60+10*	73	□ 2.740 ■ 2.920
D	150 x 45 x h 75	12	0,792	60+10*	73	□ 2.150 ■ 2.290
E	130 x 45 x h 75	12	0,688	60+10*	64	□ 1.740 ■ 1.860

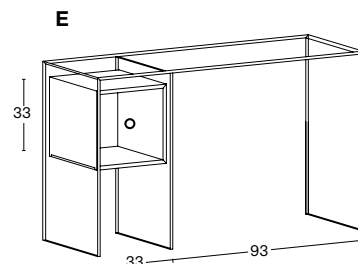
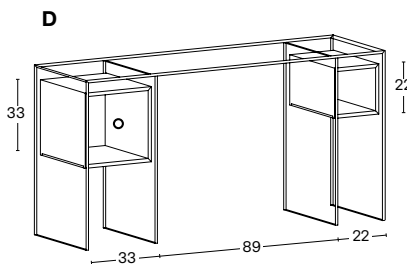
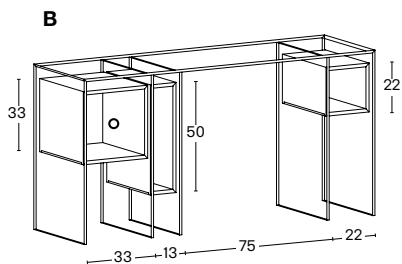

* per ogni contenitore / for each storage unit / für jeden Behälter / pour chaque récipient

□ vetro extrachiaro / extra clear glass / extrahelles Glas / verre extra clair
■ vetro fumè / smoked glass / Rauchglas / verre fumé

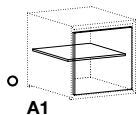

A1

A1 Optional anta battente SX in finitura Eucalipto, Siberian Ash o Rovere Naturale e ripiano interno in vetro **220**
Optional hinge door left in finish Eucalipto, Siberian Ash or natural oak and internal glass shelf
Optional Drehflügel Tür links aus Eucalipto, Siberian Ash oder Eiche Natur und internes Glasfach
Option porte à battant gauche en Eucalipto, Siberian Ash ou rouvre naturel et étagère en verre intérieur

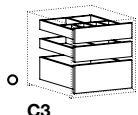

C3

C3 Optional set 3 cassetti portaoggetti, completi di separatori in legno, **520**
in finitura Eucalipto, Siberian Ash o Rovere Naturale
Optional set of 3 glove box drawers, including wooden partition,
in Eucalipto, Siberian Ash or natural oak
Optional set von 3 Handschuhfächern, komplett mit innerer Abtrennung aus Holz,
aus Eucalipto, Siberian Ash oder Eiche Natur
Option set de 3 tiroirs boîte à gants, complet de cloisons en bois,
en finition Eucalipto, Siberian Ash ou rouvre naturel

Specificare la finitura in legno dei contenitori e degli optional SIBERIAN ASH, EUCALIPTO o ROVERE NATURALE
Specify wood finish of storage unit and optional elements SIBERIAN ASH, EUCALIPTO or NATURAL OAK
Holz Ausführung der Behälter und optionalen Teile angeben SIBERIAN ASH, EUCALIPTO oder EICHE NATUR
Indiquer finition bois des récipients et des éléments optionnels SIBERIAN ASH, EUCALIPTO ou ROUVRE NATUREL

- Consolle o dressing table con struttura incollata in vetro e contenitori in legno in finitura Eucalipto, Siberian Ash o Rovere Naturale.
Optional anta battente SX o set 3 cassetti in finitura abbinata. Lo scrittoio può essere completato con lo specchio in appoggio Marcell Mirror
- Console or dressing table with glued structure made of glass and wooden storage units in Eucalipto, Siberian Ash or natural oak finish.
Optional hinge door left or set of 3 glove box drawers in matching finish. The desk can also be completed with the countertop Marcell Mirror
- Konsole oder Frisiertisch mit verklebter Struktur aus Glas und Behälter aus Holz in Ausführung Eucalipto, Siberian Ash oder Eiche Natur.
Optional Drehflügeltür links oder set von 3 Handschuhfächern in kombinierter Ausführung. Der Schreibtisch kann auch mit dem aufstellbarem Spiegel Marcell Mirror ergänzt werden
- Consolle ou coiffeuse avec structure collée en verre et récipients en bois en finition Eucalipto, Siberian Ash ou rouvre naturel.
Optionnelle porte à battant gauche ou set de 3 tiroirs boîte à gants en finition assorti.
Le bureau peut être aussi complété avec le miroir en appuy Marcell Mirror

Marcell Mirror

design Massimo Castagna 2021

Ø 40 x h 42	4	0,025		7	390
-------------	---	-------	--	---	------------

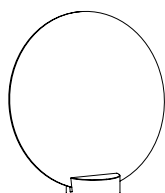

- Specchio da appoggio con base in metallo in finitura cromato lucido
- Countertop mirror with base in polished chrome
- Aufstellbarer Spiegel mit Grundlage in Chrom glänzend
- Miroir d'appui avec base en chrome brillant

	I	dimensioni	spessore	volume	carico ammesso	peso	prezzo
	E	dimension	thickness	volume	admitted load	weight	price
	D	abmessungen	stärke	volumen	tragfähigkeit	gewicht	preis
	F	dimension	épaisseur	volume	charge admise	poids	prix
		cm	mm	m3	kg	kg	euro

Marcell Desk

design Massimo Castagna 2021

F	150 x 60 x h 75	12	1,01	60+10*	94	<input type="checkbox"/> 3.430 <input checked="" type="checkbox"/> 3.760
G	150 x 60 x h 75	12	1,01	60+10*	94	<input type="checkbox"/> 2.860 <input checked="" type="checkbox"/> 3.110
H	130 x 60 x h 75	12	0,92	60+10*	81	<input type="checkbox"/> 2.200 <input checked="" type="checkbox"/> 2.390

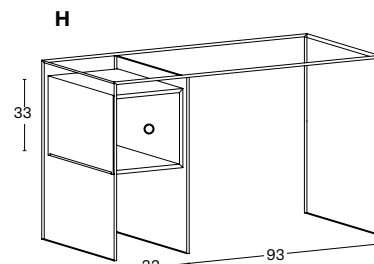
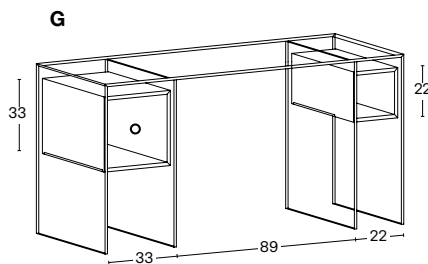
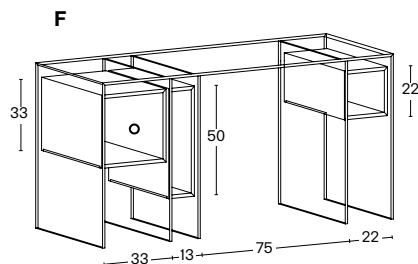

* per ogni contenitore / for each storage unit / für jeden Behälter / pour chaque récipient

- vetro extrachiaro / extra clear glass / extrahelles Glas / verre extra clair
 vetro fumè / smoked glass / Rauchglas / verre fumé

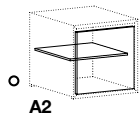

A2

- A2** Optional anta battente SX in finitura Eucalipto, Siberian Ash o Rovere Naturale e ripiano interno in vetro **240**
 Optional hinge door left in finish Eucalipto, Siberian Ash or natural oak and internal glass shelf
 Optional Drehflügel Tür links aus Eucalipto, Siberian Ash oder Eiche Natur und internes Glasfach
 Option porte à battant gauche en Eucalipto, Siberian Ash ou rouvre naturel et étagère en verre intérieur

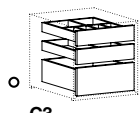

C3

- C3** Optional set 3 cassetti portaoggetti, completi di separatori in legno, **520**
 in finitura Eucalipto, Siberian Ash o Rovere Naturale
 Optional set of 3 glove box drawers, including wooden partition,
 in Eucalipto, Siberian Ash or natural oak
 Optional set von 3 Handschuhfächern, komplett mit innerer Abtrennung aus Holz,
 aus Eucalipto, Siberian Ash oder Eiche Natur
 Option set de 3 tiroirs boîte à gants, complet de cloisons en bois,
 en finition Eucalipto, Siberian Ash ou rouvre naturel

Specificare la finitura in legno dei contenitori e degli optional SIBERIAN ASH, EUCALIPTO o ROVERE NATURALE
Specify wood finish of storage unit and optional elements SIBERIAN ASH, EUCALIPTO or NATURAL OAK
Holzausführung der Behälter und optionalen Teile angeben SIBERIAN ASH, EUCALIPTO oder EICHE NATUR
Indiquer finition bois des récipients et des éléments optionnels SIBERIAN ASH, EUCALIPTO ou ROUVRE NATUREL

- Scrivitoio con struttura incollata in vetro e contenitori in legno in finitura Eucalipto, Siberian Ash o Rovere Naturale.
 Optional anta battente SX o set 3 cassetti in finitura abbinata. Lo scrivitoio può essere completato con lo specchio in appoggio Marcell Mirror
- Desk with glued structure made of glass and wooden storage units in Eucalipto, Siberian Ash or natural oak finish.
 The desk can also be completed with the countertop Marcell Mirror
- Schreibtisch mit verklebter Struktur aus Glas und Behälter aus Holz in Ausführung Eucalipto, Siberian Ash oder Eiche Natur.
 Optional Drehflügel Tür links oder set von 3 Handschuhfächern in kombinierter Ausführung.
 Der Schreibtisch kann auch mit dem aufstellbarem Spiegel Marcell Mirror ergänzt werden
- Bureau avec structure collée en verre et récipients en bois en finition Eucalipto, Siberian Ash ou rouvre naturel.
 Optionnelle porte à battant gauche ou set de 3 tiroirs boîte à gants en finition assorti.
 Le bureau peut être aussi complété avec le miroir en appuy Marcell Mirror

Marcell Mirror

design Massimo Castagna 2021

Ø 40 x h 42	4	0,025		7	390
-------------	---	-------	--	---	------------

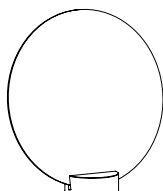

- Specchio da appoggio con base in metallo in finitura cromato lucido
- Countertop mirror with base in polished chrome
- Aufstellbarer Spiegel mit Grundlage in Chrom glänzend
- Miroir d'appui avec base en chrome brillant

	I E D F	dimensioni dimension abmessungen dimension	spessore thickness stärke épaisseur	volume volume volumen volume	carico ammesso admitted load tragfähigkeit charge admise	peso weight gewicht poids	prezzo price preis prix
		cm	mm	m3	kg	kg	euro

Maybe

design Massimo Castagna 2021



M1 M2

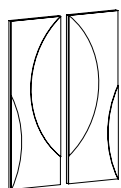

M3 M4

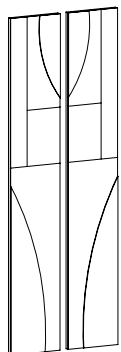

M5 M6

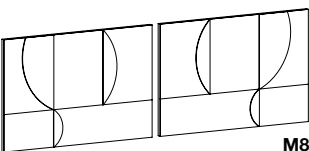

M7 M8

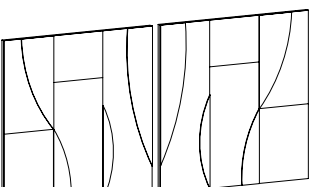

M9 M10

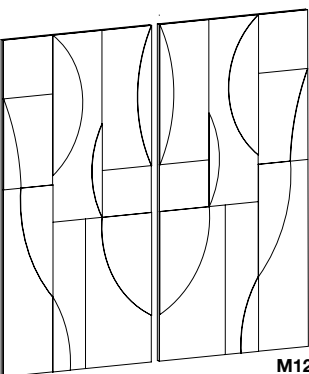

M11 M12

M1	30 x 3 x h 60	4	0,034			10	●	390
							●●	410
							●●●	420
							●●●●	510
M2	30 x 3 x h 60	4	0,034			10	●	390
							●●	410
							●●●	420
							●●●●	510
M3	30 x 3 x h 90	4	0,048			14	●	480
							●●	510
							●●●	520
							●●●●	630
M4	30 x 3 x h 90	4	0,048			14	●	480
							●●	510
							●●●	520
							●●●●	630
M5	30 x 3 x h 180	4	0,091			24	●	720
							●●	760
							●●●	770
							●●●●	940
M6	30 x 3 x h 180	4	0,091			24	●	720
							●●	760
							●●●	770
							●●●●	940
M7	90 x 3 x h 60	4	0,084			23	●	610
							●●	660
							●●●	670
							●●●●	820
M8	90 x 3 x h 60	4	0,084			23	●	610
							●●	660
							●●●	670
							●●●●	820
M9	90 x 3 x h 90	4	0,120			34	●	960
							●●	1.010
							●●●	1.020
							●●●●	1.250
M10	90 x 3 x h 90	4	0,120			34	●	960
							●●	1.010
							●●●	1.020
							●●●●	1.250
M11	90 x 3 x h 180	4	0,228			64	●	1.460
							●●	1.580
							●●●	1.590
							●●●●	1.960
M12	90 x 3 x h 180	4	0,228			64	●	1.460
							●●	1.580
							●●●	1.590
							●●●●	1.960

- Specchio / Mirror / Spiegel / Miroir
- Specchio fumè / Smoked mirror / Rauchglasspiegel / miroir fumé
- Specchio bronzo / Bronze mirror / Bronze Spiegel / Miroir bronze
- Specchio oro / Gold mirror / Gold Spiegel / miroir or

- Specchio da parete modulare e componibile formato da specchi sovrapposti di diversa forma e dimensione. Disponibile in specchio, specchio fumè, bronzo o oro. La struttura è sempre nera.

- Modular wall mirror made of juxtaposed mirrors of different shapes and dimensions. Available in mirror, smoked mirror, bronze or gold mirror. Structure is always black.

- Modularer Wandspiegel aus übereinander gelegten Spiegeln in verschiedenen Formen und Maßen. Erhältlich in Spiegel, Rauchglasspiegel, Bronze oder Gold Spiegel. Struktur ist immer schwarz.

- Miroir au mur modulaire composé de miroirs superposés en différents formes et dimensions. Disponible en miroir, miroir fumé, miroir bronze ou or. La structure est toujours noire.

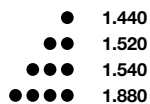

1.440
1.520
1.540
1.880

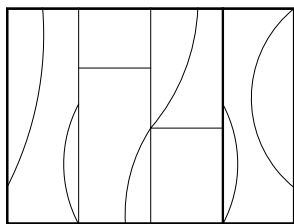

Comp. 1
120 x 3 x h 90 (M10+M3)

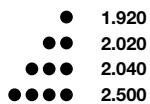

1.920
2.020
2.040
2.500

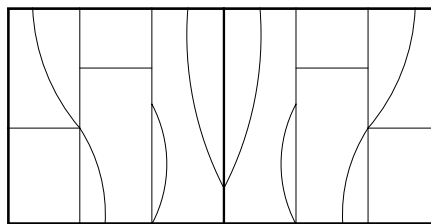

Comp. 2
180 x 3 x h 90 (M9+M10)

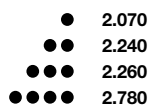

2.070
2.240
2.260
2.780

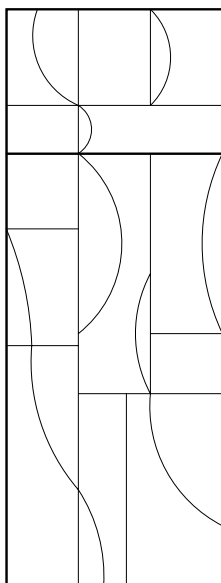

Comp. 3
90 x 3 x h 240 (M7+M11)

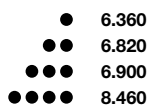

6.360
6.820
6.900
8.460

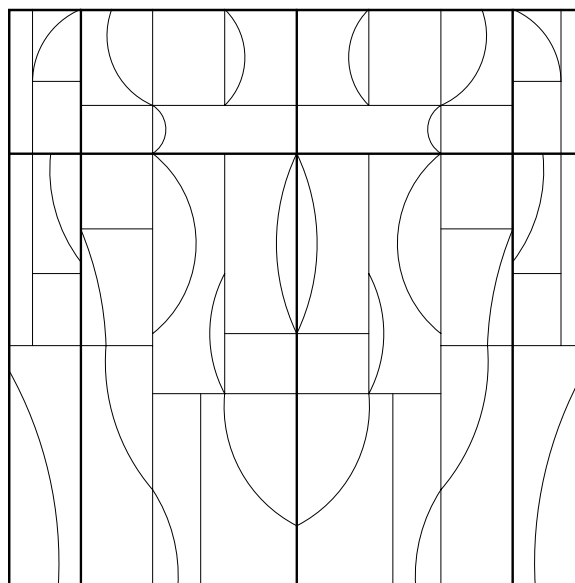

Comp. 4
240 x 3 x h 240 (M1+M7+M8+M2+M5+M11+M12+M6)

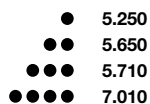

5.250
5.650
5.710
7.010

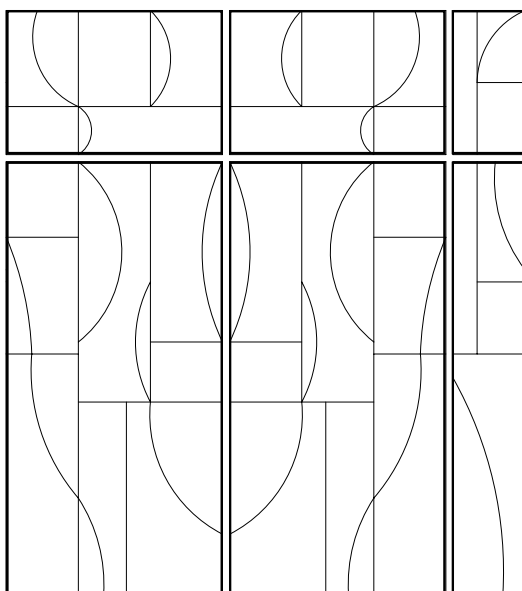

Comp. 5
vedi catalogo pag. 77 / see catalogue page 77
siehe Katalog Seite 77 / voir catalogue page 77
216 x 3 x h 243 (M7+M8+M1+M11+M12+M5)

- Esempi di composizioni che si possono ottenere accostando tra di loro gli elementi di pagina 92.
- Examples of compositions given by joining elements of page 92.
- Kompositionsbeispiele der Elemente auf Seite 92.
- Exemples de compositions qu'on peut obtenir approchant les éléments de page 92.

	I E D F	dimensioni dimension abmessungen dimension	spessore thickness stärke épaisseur	volume volume volumen volume	carico ammesso admitted load tragfähigkeit charge admise	peso weight gewicht poids	prezzo price preis prix
		cm	mm	m3	kg	kg	euro

Medora grande

100 x 37 x h174

8 / 12

1,5

7,5*

120

● 3.880

●● 3.850

design D'Urbino-Lomazzi 1995

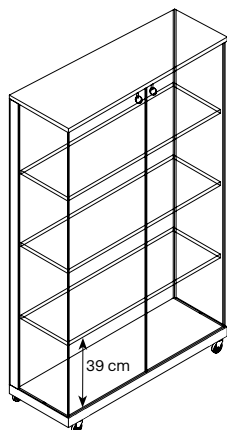

* ogni ripiano / on each shelf / auf jedem Bord / pour chaque étagère

- versione nero opaco / black matt version / schwarz matt Modell / version noir opaque
- versione bianco opaco / matt white / matt weiss / blanc opaque

- Vetrina in legno e vetro. Finiture: nero o bianco opaco. Ripiani in vetro acidato illuminati con luce led.
- Showcase in wood and glass. Finishes: matt black or white. Shelves in frosted glass with led lighting.
- Vitrine aus Holz und Glas. Ausfertigungen: schwarz oder weiß matt. Regale aus geätzttem Glas mit Led Beleuchtung.
- Vitrines en bois et verre. Finitions: noir ou blanc mat. Etagères en verre mordancé avec éclairage led.

	I E D F	dimensioni dimension abmessungen dimension	spessore thickness stärke épaisseur	volume volume volumen volume	carico ammesso admitted load tragfähigkeit charge admise	peso weight gewicht poids	prezzo price preis prix
		cm	mm	m3	kg	kg	euro

Medora piccola

50 x 37 x h 174

8 / 12

0,85

5*

60

● 2.970

●● 2.950

design D'Urbino-Lomazzi 1995

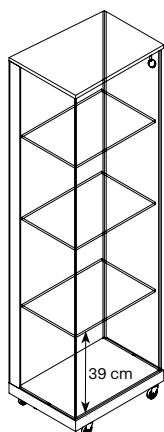

* ogni ripiano / on each shelf / auf jedem Bord / pour chaque étagère

- versione nero opaco / black matt version / schwarz matt Modell / version noir opaque
- versione bianco opaco / matt white / matt weiss / blanc opaque

- Vetrina in legno e vetro. Finiture: nero o bianco opaco. Ripiani in vetro acidato illuminati con luce led.
- Showcase in wood and glass. Finishes: matt black or white. Shelves in frosted glass with led lighting.
- Vitrine aus Holz und Glas. Ausfertigungen: schwarz oder weiß matt. Regale aus geätzttem Glas mit Led Beleuchtung.
- Vitrine en bois et verre. Finitions: noir ou blanc mat. Etagères en verre mordancé avec éclairage led.

	I E D F	dimensioni dimension abmessungen dimension	spessore thickness stärke épaisseur	volume volume volumen volume	carico ammesso admitted load tragfähigkeit charge admise	peso weight gewicht poids	prezzo price preis prix
		cm	mm	m3	kg	kg	euro

Metropolis table

design G. Maurizio Scutellà 2017

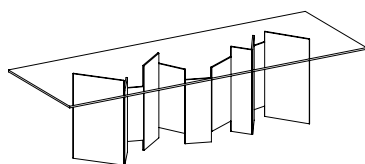

200 x 100 x h 75	12	0,58	150	115	<input type="checkbox"/> 2.560 <input checked="" type="checkbox"/> 2.920 <input type="checkbox"/> <input checked="" type="checkbox"/> 2.720 <input checked="" type="checkbox"/> <input type="checkbox"/> 2.740
225 x 90 x h 75	12	0,74	150	136	<input type="checkbox"/> 2.580 <input checked="" type="checkbox"/> 2.940 <input type="checkbox"/> <input checked="" type="checkbox"/> 2.750 <input checked="" type="checkbox"/> <input type="checkbox"/> 2.770
240 x 100 x h 75	12	0,93	150	148	<input type="checkbox"/> 2.940 <input checked="" type="checkbox"/> 3.320 <input type="checkbox"/> <input checked="" type="checkbox"/> 3.150 <input checked="" type="checkbox"/> <input type="checkbox"/> 3.170
245 x 120 x h 75	12	0,97	150	178	<input type="checkbox"/> 3.100 <input checked="" type="checkbox"/> 3.500 <input type="checkbox"/> <input checked="" type="checkbox"/> 3.310 <input checked="" type="checkbox"/> <input type="checkbox"/> 3.340
260 x 100 x h 75	12 / 12	1,15	150	195	<input type="checkbox"/> 3.050 <input checked="" type="checkbox"/> 3.450 <input type="checkbox"/> <input checked="" type="checkbox"/> 3.290 <input checked="" type="checkbox"/> <input type="checkbox"/> 3.320
280 x 100 x h 75	12 / 12	1,32	150	219	<input type="checkbox"/> 3.400 <input checked="" type="checkbox"/> 3.860 <input type="checkbox"/> <input checked="" type="checkbox"/> 3.610 <input checked="" type="checkbox"/> <input type="checkbox"/> 3.640
300 x 100 x h 75	12 / 12	1,35	150	225	<input type="checkbox"/> 3.530 <input checked="" type="checkbox"/> 3.990 <input type="checkbox"/> <input checked="" type="checkbox"/> 3.820 <input checked="" type="checkbox"/> <input type="checkbox"/> 3.860

- basamento e piana extrachiaro /extra clear base and top /Gestell und Tischplatte extrahell/piètement et top extra clair
- basamento e piana fumè /smoked base and top/Gestell und Tischplatte aus Rauchglas/piètement et top fumé
- basamento extrachiaro e piana fumè /extra clear base and smoked top/ extrahelles Gestell und Tischplatte aus Rauchglas/piètement extra clair et top fumé
- basamento fumè e piana extrachiaro /smoked base and extra clear top/ Gestell aus Rauchglas und Tischplatte extrahell/ piètement fumé et top extra clair.

- Tavolo con basamento centrale in vetro extrachiaro o fumè. Top in vetro extrachiaro o fumè.
- Dining table with central base in extra clear or smoked glass. Table top extra clear glass or smoked glass.
- Esstisch mit zentralem Gestell aus extrahellem Glas oder Rauchglas. Topplatte aus extrahellem Glas oder Rauchglas.
- Table avec piètement central en verre extra clair ou fumé. Top en verre extra clair ou fumé.

	I E D F	dimensioni dimension abmessungen dimension	spessore thickness stärke épaisseur	volume volume volumen volume	carico ammesso admitted load tragfähigkeit charge admise	peso weight gewicht poids	prezzo price preis prix
		cm	mm	m3	kg	kg	euro

Metropolis fused glass

design G. Maurizio Scutellà 2023

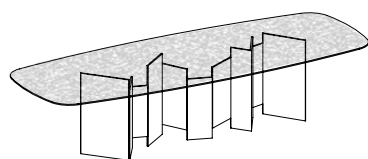

200 x 110 x h 75	12/12	0,59	150	115	■ 4.450 □ ■ 4.250
220 x 110 x h 75	12/12	0,73	150	135	■ 4.640 □ ■ 4.440
240 x 110 x h 75	12/12	0,94	150	145	■ 4.970 □ ■ 4.800
260 x 110 x h 75	12/12	1,16	150	190	■ 5.100 □ ■ 4.940
280 x 110 x h 75	12/12	1,34	150	210	■ 5.540 □ ■ 5.290
300 x 110 x h 75	12/12	1,38	150	225	■ 5.820 □ ■ 5.650
320 x 120 x h 75	12/12	1,42	150	250	■ 6.250 □ ■ 6.060

■ basamento vetro fumè e piana vetro fuso fumè / base smoked glass and top fused smoked glass

Gestell Rauchglas und Top geschmolzenes Rauchglas / piètement verre fumé et top en verre en fusion fumé

□ ■ basamento vetro extrachiario e piana vetro fuso fumè / base extra clear glass and top fused smoked glass

Gestell aus extrahellem Glas und Top geschmolzenes Rauchglas / piètement verre extra clair et top verre en fusion fumé.

- Tavolo con basamento centrale in vetro extrachiario o fumè. Top sagomato in vetro fuso fumè.

- Dining table with central base in extra clear or smoked glass. Shaped top in fused smoked glass.

- Esstisch mit zentralem Gestell aus extrahellem Glas oder Rauchglas. Profiliertes Top aus geschmolzenem Rauchglas.

- Table avec piètement central en verre extra clair ou fumé. Top profilé en verre en fusion fumé.

	I E D F	dimensioni dimension abmessungen dimension	spessore thickness stärke épaisseur	volume volume volumen volume	carico ammesso admitted load tragfähigkeit charge admise	peso weight gewicht poids	prezzo price preis prix
		cm	mm	m3	kg	kg	euro

Metropolis ceramic table

design G. Maurizio Scutellà 2017

200 x 100 x h 75	12 / 8 + 5	0,58	150	115	<input checked="" type="checkbox"/> 3.260 <input type="checkbox"/> 3.240
220 x 100 x h 75	12 / 8 + 5	0,75	150	139	<input checked="" type="checkbox"/> 3.420 <input type="checkbox"/> 3.400
240 x 100 x h 75	12 / 8 + 5	0,80	150	144	<input checked="" type="checkbox"/> 3.640 <input type="checkbox"/> 3.620
260 x 100 x h 75	12 / 8 + 5	1,15	150	195	<input checked="" type="checkbox"/> 3.900 <input type="checkbox"/> 3.880
300 x 100 x h 75	12 / 8 + 5	1,35	150	225	<input checked="" type="checkbox"/> 4.450 <input type="checkbox"/> 4.430

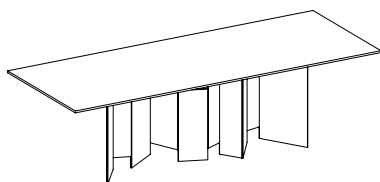

240 x 115 x h 75	12 / 8 + 5	0,97	150	178	<input checked="" type="checkbox"/> 4.280 <input type="checkbox"/> 4.260
280 x 115 x h 75	12 / 8 + 5	1,14	150	210	<input checked="" type="checkbox"/> 4.790 <input type="checkbox"/> 4.770
320 x 115 x h 75	12 / 8 + 5	1,28	150	234	<input checked="" type="checkbox"/> 5.490 <input type="checkbox"/> 5.470

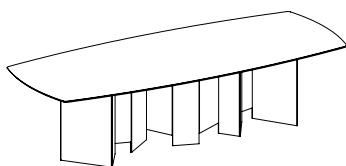

**SPECIFICARE SEMPRE LA FINITURA DEL TOP CERAMICA / ALWAYS SPECIFY CERAMIC TOP FINISH
IMMER DIE AUSFERTIGUNG DER KERAMIKPLATTE ANGEBEN / SPECIFIER TOUJOURS FINITION TOP EN CERAMIQUE**

- basamento in vetro fumè / base in smoked glass / Gestell in Rauchglas / piètement en verre fumé
- basamento in vetro extrachiaro / base in extra clear glass / Gestell in extrahellem Glas / piètement en verre extra clair

- Tavolo con basamento in vetro extrachiaro o fumè. Top in ceramica+vetro nelle seguenti finiture: **Pietra di Savoia antracite bocciardato, Noir desir lucido o opaco, Emperador lucido o opaco, Calacatta oro venato lucido, Pietra Grey lucido o opaco, Sahara noir lucido o bocciardato.**
- Dining table with base in extra clear or smoked glass. Top made of ceramic+glass with following finishes: **Pietra di Savoia antracite bocciardato, Noir desir polished or matt, Emperador polished or matt, Calacatta oro venato polished, Pietra Grey polished or matt, Sahara noir polished or bocciardato.**
- Esstisch mit Gestell aus extrahellem Glas oder Rauchglas. Top aus Keramik+Glas in folgenden Ausfertigungen: **Pietra di Savoia Anthrazit bocciardato, Noir desir glänzend oder matt, Emperador glänzend oder matt, Calacatta oro venato glänzend, Pietra Grey glänzend oder matt, Sahara noir glänzend oder bocciardato.**
- Table avec piètement en verre extra clair ou fumé. Top en céramique+verre dans les suivants finitions: **Pietra di Savoia anthracite mat, Noir desir brillant ou mat, Emperador brillant ou mat, Calacatta oro venato brillant, Pietra Grey brillant ou mat, Sahar noir brillant ou bocciardato.**

	I E D F	dimensioni dimension abmessungen dimension	spessore thickness stärke épaisseur	volume volume volumen volume	carico ammesso admitted load tragfähigkeit charge admise	peso weight gewicht poids	prezzo price preis prix
		cm	mm	m3	kg	kg	euro

Metropolis console

design G. Maurizio Scutellà 2017

120 x 45 x h 75

12

0,37

50

67

1.300

1.490

1.370

1.410

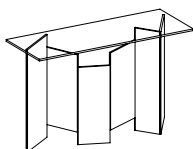

- basamento e piana extrachiaro /extra clear base and top /Gestell und Tischplatte extrahell/piètement et top extra clair
- basamento e piana fumè /smoked base and top/Gestell und Tischplatte aus Rauchglas/piètement et top fumé
- basamento extrachiaro e piana fumè /extra clear base and smoked top/ extrahelles Gestell und Tischplatte aus Rauchglas/piètement extra clair et top fumé
- basamento fumè e piana extrachiaro /smoked base and extra clear top/ Gestell aus Rauchglas und Tischplatte extrahell/ piètement fumé et top extra clair.

- Console con base centrale in vetro extrachiaro o fumè. Top in vetro extrachiaro o fumè.
- Console with central base in extra clear or smoked glass. Top in extra clear or smoked glass.
- Konsole mit zentralem Gestell aus extrahellem Glas oder Rauchglas. Topplatte aus extrahellem Glas oder Rauchglas.
- Console avec piètement central en verre extra clair ou fumé. Top en verre extra clair ou fumé.

Metropolis ceramic console

design G. Maurizio Scutellà 2017

105 x 45 x h 75

12 / 8 + 5

0,37

50

61

1.520

1.510

120 x 45 x h 75

12 / 8 + 5

0,42

50

72

1.620

1.610

160 x 45 x h 75

12 / 8 + 5

0,56

50

83

1.980

1.970

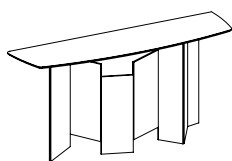

- basamento in vetro fumè / base in smoked glass / Gestell in Rauchglas / piètement en verre fumé
- basamento in vetro extrachiaro / base in extra clear glass / Gestell in extrahellem Glas / piètement en verre extra clair

- Console con basamento in vetro extrachiaro o fumè. Top in ceramica+vetro nelle seguenti finiture: **Pietra di Savoia antracite bocciardato, Noir desir lucido o opaco, Emperador lucido o opaco, Calacatta oro venato lucido, Pietra Grey lucido o opaco, Sahara noir lucido o bocciardato**
- Console with base in extra clear or smoked glass. Top made of ceramic+glass with following finishes: **Pietra di Savoia anthracite bocciardato, Noir desir polished or matt, Emperador polished or matt, Calacatta oro venato polished, Pietra Grey polished or matt, Sahara noir polished or bocciardato.**
- Konsole mit Gestell aus extrahellem Glas oder Rauchglas. Top aus Keramik+Glas in folgenden Ausfertigungen: **Pietra di Savoia Anthrazit bocciardato, Noir desir glänzend oder matt, Emperador glänzend oder matt, Calacatta oro venato glänze**
- Console avec piètement en verre extra clair ou fumé. Top en céramique+verre dans les suivants finitions: **Pietra di Savoia anthracite mat, Noir desir brillant ou mat, Emperador brillant ou mat, Calacatta oro venato brillant, Pietra Grey brillant ou mat, Sahar noir brillant ou bocciardato.**

	I E D F	dimensioni dimension abmessungen dimension	spessore thickness stärke épaisseur	volume volume volumen volume	carico ammesso admitted load tragfähigkeit charge admise	peso weight gewicht poids	prezzo price preis prix
		cm	mm	m3	kg	kg	euro

Metropolis low table

design G. Maurizio Scutellà 2017

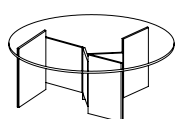
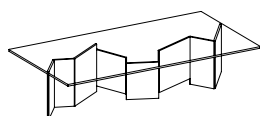

130 x 70 x h 35

12

0,31

50

61

1.140

1.260

1.200

1.210

1.400

1.570

1.460

1.510

960

1.010

1.000

970

150 x 80 x h 35

12

0,48

50

80

Ø 90 x h 35

12

0,36

50

49

- basamento e piana extrachiaro /extra clear base and top /Gestell und Tischplatte extrahell/piètement et top extra clair
- basamento e piana fumè /smoked base and top/Gestell und Tischplatte aus Rauchglas/piètement et top fumé
- basamento extrachiaro e piana fumè /extra clear base and smoked top/ extrahelles Gestell und Tischplatte aus Rauchglas/piètement extra clair et top fumé
- basamento fumè e piana extrachiaro /smoked base and extra clear top/ Gestell aus Rauchglas und Tischplatte extrahell/ piètement fumé et top extra clair.

- Tavolo basso con base centrale in vetro extrachiaro o fumè. Top in vetro extrachiaro o fumè.
- Low table with central base in extra clear or smoked glass. Top in extra clear or smoked glass.
- Niedriger Tisch mit zentralem Gestell in extrahellem Glas oder Rauchglas. Topplatte aus extrahellem Glas oder Rauchglas.
- Table basse avec piètement centra en verre extra clair ou fumé. Top en verre extra clair ou fumé.

Metropolis side table

design G. Maurizio Scutellà 2017



50 x 50 x h 55

12

0,25

50

32

750

810

780

800

770

880

810

830

Ø 60 x h 55

10/12

0,34

50

34

- basamento e piana extrachiaro /extra clear base and top /Gestell und Tischplatte extrahell/piètement et top extra clair
- basamento e piana fumè /smoked base and top/Gestell und Tischplatte aus Rauchglas/piètement et top fumé
- basamento extrachiaro e piana fumè /extra clear base and smoked top/ extrahelles Gestell und Tischplatte aus Rauchglas/piètement extra clair et top fumé
- basamento fumè e piana extrachiaro /smoked base and extra clear top/ Gestell aus Rauchglas und Tischplatte extrahell/ piètement fumé et top extra clair.

- Comodino o fianco divano con base in vetro extrachiaro o fumè. Top in vetro extrachiaro o fumè.
- Bedside table or side table with base in extra clear or smoked glass. Top in extra clear or smoked glass.
- Nachttisch oder Beistelltisch mit Gestell aus extrahellem Glas oder Rauchglas.
Topplatte aus extrahellem Glas oder Rauchglas.
- Table de nuit ou table de chevet avec piètement en verre extra clair ou fumé. Top en verre extra clair ou fumé.

	I E D F	dimensioni dimension abmessungen dimension	spessore thickness stärke épaisseur	volume volume volumen volume	carico ammesso admitted load tragfähigkeit charge admise	peso weight gewicht poids	prezzo price preis prix
		cm	mm	m3	kg	kg	euro

Metropolis ceramic low table

design G. Maurizio Scutellà 2017

120x60 x h 35	12 / 8 + 5	0,29	50	59	■ 1.480 □ 1.470
130x70 x h 35	12 / 8 + 5	0,33	50	75	■ 1.580 □ 1.570
160x80 x h 35	12 / 8 + 5	0,49	50	89	■ 2.180 □ 2.170
Ø 95 x h 35	12 / 8 + 5	0,37	50	52	■ 1.570 □ 1.560

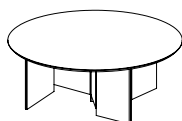
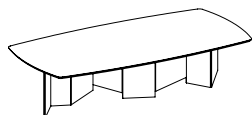

- basamento in vetro fumè / base in smoked glass / Gestell in Rauchglas / piètement en verre fumé
- basamento in vetro extrachiaro / base in extra clear glass / Gestell in extrahellem Glas / piètement en verre extra clair

- Tavolo basso con basamento in vetro extrachiaro o fumè. Top in ceramica+vetro nelle seguenti finiture: **Pietra di Savoia antracite bocciardato, Noir desir lucido o opaco, Emperador lucido o opaco, Calacatta oro venato lucido, Pietra Grey lucido o opaco, Sahara noir lucido o bocciardato.**
- Cocktail table with base in extra clear or smoked glass. Top made of ceramic+glass with following finishes: **Pietra di Savoia anthracite bocciardato, Noir desir polished or matt, Emperador polished or matt, Calacatta oro venato polished, Pietra Grey polished or matt, Sahara noir polished or bocciardato.**
- Couchtisch mit Gestell aus extrahellem Glas oder Rauchglas. Top aus Keramik+Glas in folgenden Ausfertigungen: **Pietra di Savoia Anthrazit bocciardato, Noir desir glänzend oder matt, Emperador glänzend oder matt, Calacatta oro venato glänzend, Pietra Grey glänzend oder matt, Sahara noir glänzend oder bocciardato.**
- Table basse avec piètement en verre extra clair ou fumé. Top en céramique+verre dans les suivants finitions: **Pietra di Savoia anthracite mat, Noir desir brillant ou mat, Emperador brillant ou mat, Calacatta oro venato brillant, Pietra Grey brillant ou mat, Sahar noir brillant ou bocciardato.**

Metropolis ceramic side table

design G. Maurizio Scutellà 2017

60 x 60 x h 55	12 / 8 + 5	0,34	50	37	■ 1.140 □ 1.130
Ø 75 x h 55	12 / 8 + 5	0,50	50	45	■ 1.330 □ 1.320

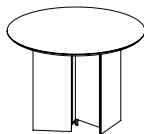

- basamento in vetro fumè / base in smoked glass / Gestell in Rauchglas / piètement en verre fumé
- basamento in vetro extrachiaro / base in extra clear glass / Gestell in extrahellem Glas / piètement en verre extra clair

- Comodino o fianco divano con basamento in vetro extrachiaro o fumè. Top in ceramica+vetro nelle seguenti finiture: **Pietra di Savoia antracite bocciardato, Noir desir lucido o opaco, Emperador lucido o opaco, Calacatta oro venato lucido, Pietra Grey lucido o opaco, Sahara noir lucido o bocciardato.**
- Bedside table or side table with base in extra clear or smoked glass. Top made of ceramic+glass with following finishes: **Pietra di Savoia anthracite bocciardato, Noir desir polished or matt, Emperador polished or matt, Calacatta oro venato polished, Pietra Grey polished or matt, Sahara noir polished or bocciardato.**
- Nachttisch oder Beistelltisch mit Gestell aus extrahellem Glas oder Rauchglas. Top aus Keramik+Glas in folgenden Ausfertigungen: **Pietra di Savoia Anthrazit bocciardato, Noir desir glänzend oder matt, Emperador glänzend oder matt, Calacatta oro venato glänzend, Pietra Grey glänzend oder matt, Sahara noir glänzend oder bocciardato.**
- Table de nuit ou table de chevet avec piètement en verre extra clair ou fumé. Top en céramique+verre dans les suivants finitions: **Pietra di Savoia anthracite mat, Noir desir brillant ou mat, Emperador brillant ou mat, Calacatta oro venato brillant, Pietra Grey brillant ou mat, Sahar noir brillant ou bocciardato.**

	I E D F	dimensioni dimension abmessungen dimension	spessore thickness stärke épaisseur	volume volume volumen volume	carico ammesso admitted load tragfähigkeit charge admise	peso weight gewicht poids	prezzo price preis prix
		cm	mm	m3	kg	kg	euro

Metropolis XXL

Ø 240 x h 75

12

3,60

150

347

8.780

9.920

9.430

9.040

design G. Maurizio Scutellà 2022

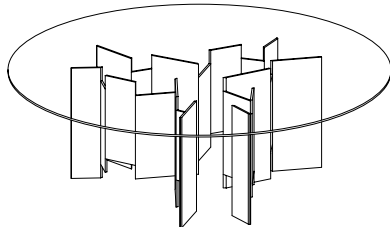

Metropolis XXL

400 x 120 x h 75

12

2,52

150

300

8.710

9.840

8.980

9.100

design G. Maurizio Scutellà 2022

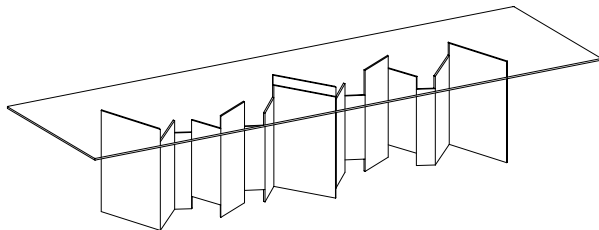

basamento e piano extra chiaro / extra clear base and top
Gestell und Tischplatte extrahell / piètement et top extra clair

basamento e piano fumè / smoked base and top
Gestell und Tischplatte aus Rauchglas/piètement et top fumé

basamento extra chiaro e piano fumè / extra clear base and smoked top
extrahelles Gestell und Tischplatte aus Rauchglas / piètement extra clair et top fumé

basamento fumè e piano extra chiaro / smoked base and extra clear top / Gestell aus Rauchglas und
Tischplatte extrahell / piètement fumé et top extra clair.

- Tavolo con top di grandi dimensioni in appoggio in vetro extra chiaro o fumè temperato. Basamento centrale composto da più elementi accostabili in vetro extra chiaro o fumè.

- Table with big dimension top in tempered extra clear or smoked glass. Central base made of several elements put next to each other in extra clear or smoked glass.

- Tisch mit Top in großen Maßen aus Sicherheitsglas extrahell oder Rauchglas. Zentrales Gestell aus mehreren zusammenstellbaren Elementen aus extrahellem Glas oder Rauchglas.

- Table avec top en grands dimensions en verre extra clair ou fumé trempé. Piètement central composé de plusieurs éléments approchables en verre extra clair ou fumé.

	I E D F	dimensioni dimension abmessungen dimension	spessore thickness stärke épaisseur	volume volume volumen volume	carico ammesso admitted load tragfähigkeit charge admise	peso weight gewicht poids	prezzo price preis prix
		cm	mm	m3	kg	kg	euro

Metropolis XXL

320 x 160 x h 75

12

3,09

150

366

9.120

10.300

9.420

9.600

design G. Maurizio Scutellà 2022

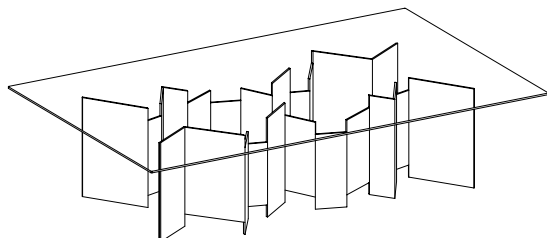

Metropolis XXL

320 x 200 x h 75

12

3,22

150

406

9.950

11.240

10.410

10.600

design G. Maurizio Scutellà 2022

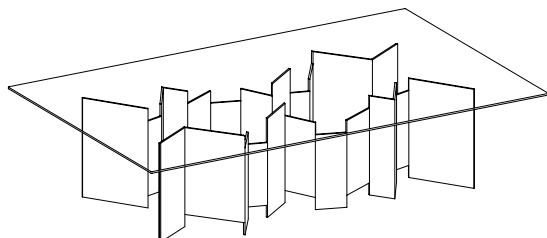

basamento e piano extra chiaro / extra clear base and top
Gestell und Tischplatte extrahell / piètement et top extra clair

basamento e piano fumè / smoked base and top
Gestell und Tischplatte aus Rauchglas/piètement et top fumé

basamento extra chiaro e piano fumè / extra clear base and smoked top
extrahelles Gestell und Tischplatte aus Rauchglas / piètement extra clair et top fumé

basamento fumè e piano extra chiaro / smoked base and extra clear top / Gestell aus Rauchglas und
Tischplatte extrahell / piètement fumé et top extra clair.

- Tavolo con top di grandi dimensioni in appoggio in vetro extra chiaro o fumè temperato. Basamento centrale composto da più elementi accostabili in vetro extra chiaro o fumè.

- Table with big dimension top in tempered extra clear or smoked glass. Central base made of several elements put next to each other in extra clear or smoked glass.

- Tisch mit Top in großen Maßen aus Sicherheitsglas extrahell oder Rauchglas. Zentrales Gestell aus mehreren zusammenstellbaren Elementen aus extrahellem Glas oder Rauchglas.

- Table avec top en grands dimensions en verre extra clair ou fumé trempé. Piètement central composé de plusieurs éléments approchables en verre extra clair ou fumé.

	I E D F	dimensioni dimension abmessungen dimension	spessore thickness stärke épaisseur	volume volume volumen volume	carico ammesso admitted load tragfähigkeit charge admise	peso weight gewicht poids	prezzo price preis prix
		cm	mm	m3	kg	kg	euro

Miles

design Giulio Mancini 2007/2019

STRUTTURA VERNICIATA NERO / STRUCTURE BLACK LACQUERED / STRUKTUR SCHWARZ LACKIERT / STRUCTURE LAQUE NOIR

200 x 100 x h 74	12	0,96	180	155	3.290 □ 3.480 ■ 3.580
225 x 90 x h 74	12	0,96	180	152	3.310 □ 3.500 ■ 3.600
240 x 100 x h 74	12	0,97	180	162	3.350 □ 3.580 ■ 3.700
245 x 120 x h 74	12	1,02	180	186	3.600 □ 3.930 ■ 4.070

STRUTTURA VERNICIATA BIANCO / STRUCTURE WHITE LACQUERED / STRUKTUR WEISS LACKIERT / STRUCTURE LAQUE BLANC

200 x 100 x h 74	12	0,96	180	155	3.290 □ 3.480 ■ 3.580
225 x 90 x h 74	12	0,96	180	152	3.310 □ 3.500 ■ 3.600
240 x 100 x h 74	12	0,97	180	162	3.350 □ 3.580 ■ 3.700
245 x 120 x h 74	12	1,02	180	186	3.600 □ 3.930 ■ 4.070

STRUTTURA CROMATA / STRUCTURE CHROME / STRUKTUR CHROM / STRUCTURE CHROME

200 x 100 x h 74	12	0,96	180	155	3.590 □ 3.780 ■ 3.890
225 x 90 x h 74	12	0,96	180	152	3.610 □ 3.810 ■ 3.920
240 x 100 x h 74	12	0,97	180	162	3.650 □ 3.890 ■ 4.000
245 x 120 x h 74	12	1,02	180	186	3.910 □ 4.240 ■ 4.390

STRUTTURA CANNA DI FUCILE / GUNMETAL STRUCTURE / GUNMETAL STRUKTUR / STRUCTURE GUNMETAL

200 x 100 x h 74	12	0,96	180	155	4.850 □ 5.040 ■ 5.150
225 x 90 x h 74	12	0,96	180	152	4.870 □ 5.070 ■ 5.180
240 x 100 x h 74	12	0,97	180	162	4.910 □ 5.150 ■ 5.260
245 x 120 x h 74	12	1,02	180	186	5.170 □ 5.500 ■ 5.660

- Vetro extrachiaro / extra clear glass / extrahelles Glas / verre extra clair
- Vetro fumé / smoked glass / Rauchglas / verre fumé

- Tavolo in vetro trasparente, extrachiaro o fumé con basamento in metallo in finitura cromata o canna di fucile, verniciato nero o bianco opaco.
- Dining table in transparent, extra clear or smoked glass with metal base in chrome finish or gunmetal, matt black or white lacquered.
- Esstisch aus transparentem, extrahellem Glas oder Rauchglas mit Metallgestell aus Chrom oder Gunmetal, schwarz oder weiß matt lackiert.
- Table en verre transparent, extra clair ou fumé avec piètement en métal en finition chromé ou gunmetal, laqué mat noir ou blanc.

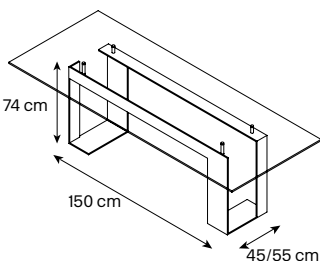

	I E D F	dimensioni dimension abmessungen dimension	spessore thickness stärke épaisseur	volume volume volumen volume	carico ammesso admitted load tragfähigkeit charge admise	peso weight gewicht poids	prezzo price preis prix
		cm	mm	m3	kg	kg	euro

Naked

72 x 90 x h 76

20

0,224

130

67

4.120

□ 4.230

design G.T. Garattoni 2002

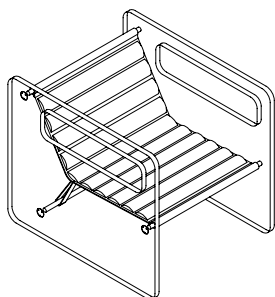

□ Vetro extrachiario / extra clear glass / extrahelles Glas / verre extra clair

- Poltrona in vetro temperato con seduta in pelle nera o bianca.
- Armchair in toughened glass with white or black leather seat.
- Sessel aus Hartglas mit schwarzem oder weißem Ledersitz.
- Fauteuil en verre trempé avec assise en cuir noir ou blanc.

Nicchio

Ø 40 x h 45

15

0,150

15

15

660

□ 710

design M. U.

Ø 40 x h 65

15

0,203

15

17

680

□ 730

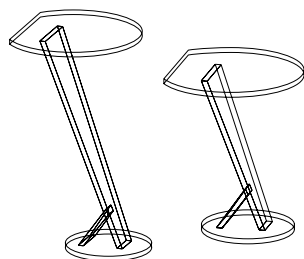

□ Vetro extrachiario / extra clear glass / extrahelles Glas / verre extra clair

- Tavolino multiuso
- Small table
- Mehrzwecktisch
- Petite table à multiples emplois

	I	dimensioni	spessore	volume	carico ammesso	peso	prezzo
	E	dimension	thickness	volume	admitted load	weight	price
	D	abmessungen	stärke	volumen	tragfähigkeit	gewicht	preis
	F	dimension	épaisseur	volume	charge admise	poids	prix
		cm	mm	m3	kg	kg	euro

Noom design Massimo Castagna 2022	S90	56 x 7 x h 90		0,06		8	910
	S120	56 x 7 x h 120		0,08		10	980

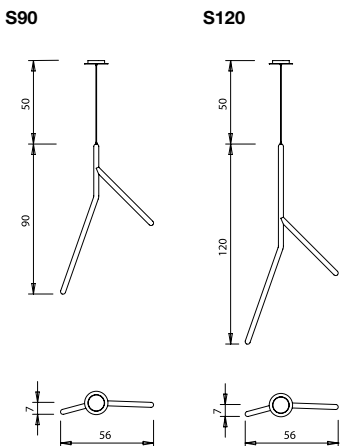

Maggiorazione per impianto dimmerabile
Surcharge for dimmer system
Aufpreis für Dimmer System.
Augmentation pour système gradable.

90

specificare sempre la finitura della struttura in legno SIBERIAN ASH, EUCALIPTO o ROVERE NATURALE
always specify finish of wooden structure SIBERIAN ASH, EUCALIPTO OR NATURAL OAK
immer Ausführung der Holzstruktur angeben SIBERIAN ASH, EUCALIPTO ODER EICHE NATUR
toujours spécifier finition de la structure en bois SIBERIAN ASH, EUCALIPTO OU ROUVRE NATUREL

specificare il paese di destinazione
specify country of destination
immer Zielland angeben
toujours indiquer pays de destination

- Lampada a sospensione in legno massello in finitura SIBERIAN ASH, EUCALIPTO o ROVERE NATURALE. Impianto di illuminazione a luce LED COB 13W 1200LM, non dimmerabile. Cavo di sospensione nero in dotazione fino a 1,5mt.
- Hanging lamp in solid wood in finish SIBERIAN ASH, EUCALIPTO OR NATURAL OAK. Lighting system with LED COB 13W 1200LM 3000°K, not dimmable. Provided with suspension cable up to 1,5mt.
- Hängelampe aus Massivholz in Ausführung SIBERIAN ASH, EUCALIPTO ODER EICHE NATUR. Leuchtsystem mit LED COB 13W 1200LM 3000°K, nicht dimmbar. Inkl. Hängekabel bis zu 1,5mt.
- Lampe à suspension en bois massif en finition SIBERIAN ASH, EUCALIPTO OU ROUVRE NATUREL. Système d'illumination avec LED COB 13W 1200LM 3000°K, non gradable. Cable de suspension jusqu'à 1,5mt inclus.

Noom design Massimo Castagna 2022	XL90	59 x 24 x h 90		0,12		15	1.780
	XL120	59 x 24 x h 120		0,16		19	1.920

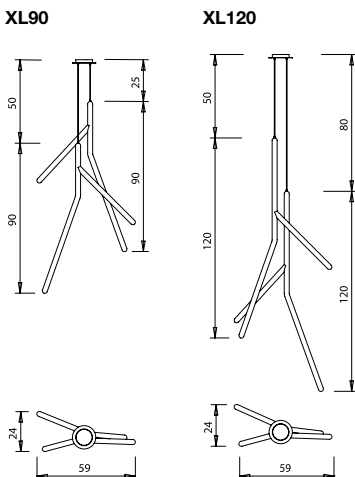

Maggiorazione per impianto dimmerabile
Surcharge for dimmer system
Aufpreis für Dimmer System.
Augmentation pour système gradable.

90

specificare sempre la finitura della struttura in legno SIBERIAN ASH, EUCALIPTO o ROVERE NATURALE
always specify finish of wooden structure SIBERIAN ASH, EUCALIPTO OR NATURAL OAK
immer Ausführung der Holzstruktur angeben SIBERIAN ASH, EUCALIPTO ODER EICHE NATUR
toujours spécifier finition de la structure en bois SIBERIAN ASH, EUCALIPTO OU ROUVRE NATUREL

specificare il paese di destinazione
specify country of destination
immer Zielland angeben
toujours indiquer pays de destination

- Lampada a sospensione a due elementi con rosone unico in legno massello in finitura SIBERIAN ASH, EUCALIPTO o ROVERE NATURALE. Impianto di illuminazione a luce LED COB 26W 2400LM, non dimmerabile. Cavo di sospensione nero in dotazione fino a 1,5mt.
- Hanging lamp with two elements and one ceiling rose in solid wood in finish SIBERIAN ASH, EUCALIPTO OR NATURAL OAK. Lighting system with LED COB 26W 2400LM, not dimmable. Provided with black suspension cable up to 1,5mt.
- Hängelampe mit zwei Elementen und einziger Deckenrosette aus Massivholz in Ausführung SIBERIAN ASH, EUCALIPTO ODER EICHE NATUR. Leuchtsystem mit LED COB 26W 2400LM, nicht dimmbar. Inkl. schwarzer Hängekabel bis zu 1,5mt.
- Lampe à suspension avec deux éléments et une seule rose en bois massif SIBERIAN ASH, EUCALIPTO OU ROUVRE NATUREL. Système d'illumination avec LED COB 26W 2400LM, non gradable. Cable de suspension jusqu'à 1,5mt inclus.

	I E D F	dimensioni dimension abmessungen dimension	spessore thickness stärke épaisseur	volume volume volumen volume	carico ammesso admitted load tragfähigkeit charge admise	peso weight gewicht poids	prezzo price preis prix
		cm	mm	m3	kg	kg	euro
Noom design Massimo Castagna 2022	M90	56 x 7 x h 90		0,06		9	990
	M120	56 x 7 x h 120		0,08		11	1.060

M90

M120

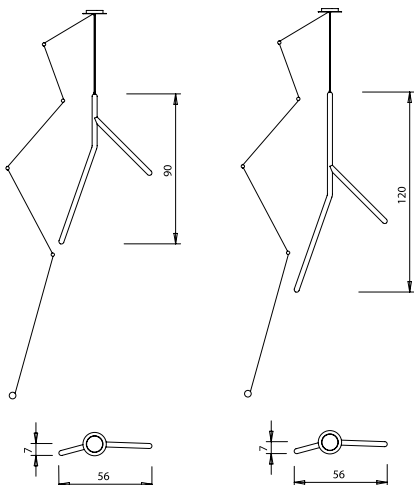

Maggiorazione per impianto dimmerabile
 Surcharge for dimmer system
 Aufpreis für Dimmer System.
 Augmentation pour système gradable.

120

specificare sempre la finitura della struttura in legno SIBERIAN ASH, EUCALIPTO o ROVERE NATURALE
always specify finish of wooden structure SIBERIAN ASH, EUCALIPTO OR NATURAL OAK
immer Ausführung der Holzstruktur angeben SIBERIAN ASH, EUCALIPTO ODER EICHE NATUR
toujours spécifier finition de la structure en bois SIBERIAN ASH, EUCALIPTO OU ROUVRE NATUREL

specificare il paese di destinazione
 specify country of destination
 immer Zielland angeben
 toujours indiquer pays de destination

- Lampada a sospensione in legno massello in finitura SIBERIAN ASH, EUCALIPTO o ROVERE NATURALE.
 Impianto di illuminazione a luce LED COB 13W 1200LM 3000°K, non dimmerabile. In dotazione cavo di sospensione fino a 5mt. predisposto per alimentazione da presa a muro e n. 05 ferma cavo di colore nero per fissaggio alla parete.
- Hanging lamp in solid wood in finish SIBERIAN ASH, EUCALIPTO OR NATURAL OAK.
 Lighting system with LED COB 13W 1200LM 3000°K, not dimmable. Provided with suspension cable up to 5mt, set up for power supply by wall socket and n. 05 cable stoppers in black for wall fixing.
- Hängelampe aus Massivholz in Ausführung SIBERIAN ASH, EUCALPTO ODER EICHE NATUR.
 Leuchtsystem mit LED COB 13W 1200LM 3000°K, nicht dimmbar. Inkl. Hängekabel bis zu 5mt, vorgesehen mit Stromversorgung durch Wand Steckdose und n. 05 schwarzen Kabelbinder für Wandbefestigung.
- Lampe à suspension en bois massif en finition SIBERIAN ASH, EUCALIPTO OU ROUVRE NATUREL.
 Système d'illumination avec LED COB 13W 1200LM 3000°K, non gradable. Inclus cable de suspension jusq'à 5mt préparé pour alimentation avec prise de courant au mur e n. 05 serres-cable de couleur noir pour fixation au mur.

	I E D F	dimensioni dimension abmessungen dimension	spessore thickness stärke épaisseur	volume volume volumen volume	carico ammesso admitted load tragfähigkeit charge admise	peso weight gewicht poids	prezzo price preis prix
		cm	mm	m3	kg	kg	euro

Ozma

design Viola Tonucci 2017

Ø 100 x 5	4	0,15		39	1.980
-----------	---	------	--	----	-------

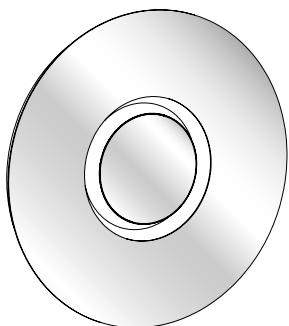

- Specchio tondo da parete. Parte centrale estraibile in finitura dorata, utilizzabile come centrotavola Ø 35 cm.
- Round wall mirror. Extractable central part in gold finish, that can be used as centrepiece Ø 35 cm.
- Runder Wandspiegel. Zentraler Teil in goldener Ausfertigung kann herausgenommen werden und als Tafelaufsatz benutzt werden Ø 35 cm.
- Miroir à mur ronde. Part central extractible en finition doré, utilisable comme pièce maîtresse Ø 35 cm.

Opalina toeletta

design Cristina Celestino 2016

80 x 56 x h 130	12 / 4	0,619	40	68	<input type="checkbox"/> 2.070
					<input checked="" type="checkbox"/> 2.660

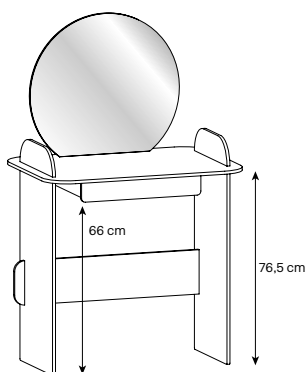

- Top extrachiaro satinato, fianchi extrachiaro e cassetto verniciato bianco / extra clear frosted top + extra clear sides + mat white lacquered wooden drawer / Top extrahell geätzt + Seiten extrahell + Schublade aus Holz matt weiß / top extra clair + cotés extra clair + tiroir en bois laqué blanc opaque
- Top e fianchi fumè, specchio fumè e cassetto pelle beige / smoked top and sides + smoked mirror + beige leather drawer / Top und Seiten Rauchglas + Rauchglas Spiegel + beige Lederschublade / top et cotés en verre fumé + miroir fumé + tiroir cuir beige

- Toeletta con struttura in vetro extra chiaro satinato o fumè, con specchio, cassetto estraibile disponibile in legno bianco o rivestito in pelle beige.
- Dressing table with extra clear frosted or smoked glass structure, with mirror, pull-out drawer in white wood or covered in beige leather.
- Frisiertisch mit Struktur aus extrahell geätztem Glas oder Rauchglas, mit Spiegel, ausziehbarer Schublade aus weißem Holz oder mit beigem Leder bezogen.
- Coiffeuse avec structure en verre extra clair mordancé ou fumé, avec miroir, tiroir extractible disponible en bois blanc ou recouvert en cuir beige.

Opalina sgabello

design Cristina Celestino 2016

Ø 38 x h 45	12	0,138	80	18	<input type="checkbox"/> 560
					<input type="checkbox"/> 620
					<input checked="" type="checkbox"/> 680



Cuscino in pelle beige / **Cushion** in beige leather / **Kissen** aus beigem Leder / **Coussin** en cuir beige **360**

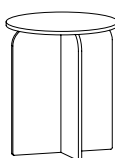

- Top in vetro extrachiaro satinato e base extrachiaro / top in extra clear frosted glass and extra clear base
- Top in extrahell geätztem Glas und Gestell extrahell / Top en verre extra clair mordancé e base extra clair
- Vetro Extrachiaro satinato / Extra clear frosted glass / Extrahell geätztes Glas / Extra clair mordancé
- Vetro fumé / smoked glass / Rauchglas / verre fumé

- Sgabello o fianco divano in vetro extra chiaro, extra chiaro satinato o fumè. Optional cuscino in pelle beige.
- Stool or side table in extra clear, extra clear frosted or smoked glass. Optional cushion in beige leather.
- Hocker oder Beistelltisch in extrahellem, extrahell geätztem Glas oder Rauchglas. Optionaler Kissen aus beigem Leder.
- Tabouret ou table de chevet en verre extra clair, extra clair mordancé ou fumé. Optionnel coussin en cuir beige.

	I E D F	dimensioni dimension abmessungen dimension	spessore thickness stärke épaisseur	volume volume volumen volume	carico ammesso admitted load tragfähigkeit charge admise	peso weight gewicht poids	prezzo price preis prix
		cm	mm	m3	kg	kg	euro

Opalina console

design Cristina Celestino 2016

120 x 45 x h 86 | 12 | 0,751 | 40 | 72 | 1.480

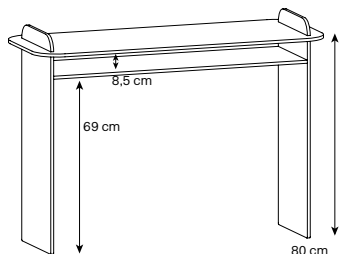

Extrachiaro / extra clear / extrahell / extra clair

- Console/scrivania con struttura in vetro extrachiaro.
- Console/desk with extra clear structure.
- Konsoltisch mit Struktur aus extrahellem Glas.
- Console/bureau avec structure en verre extra clair.

Paradigma

design Debonademeo studio 2019

A 173 x 40 x h 230 | 12 | 2,63 | *30 | 290 | 7.490
 7.720
B 177 x 40 x h 167 | 12 | 2 | *30 | 262 | 7.040
 7.320

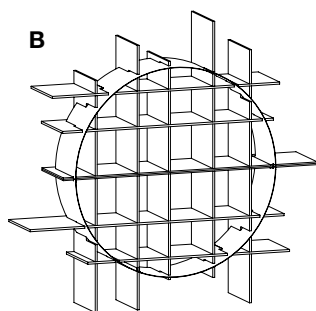
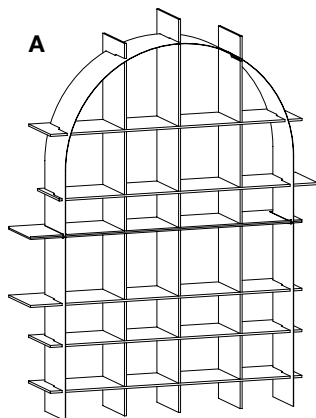

specificare sempre la finitura della struttura ad arco/cerchio
 always specify finish of arc/circle
 immer Ausführung des Bogen/Kreis angeben
 toujours spécifier finition arc/cercle

* ogni ripiano / on each shelf / auf jedem Bord / pour chaque étagère

- Vetro extrachiaro / extra clear glass / extrahelles Glas / verre extra clair
 Vetro fumé / smoked glass / Rauchglas / verre fumé

- Libreria freestanding composta da fianchi e ripiani in vetro extrachiaro o fumé uniti ad una struttura ad arco o a cerchio disponibile in **bronzo spazzolato o nero spazzolato**. La libreria è sempre fornita in due pezzi separati.
- Freestanding bookcase made of extra clear or smoked glass sides and shelves joint to an arch or circular structure in **brushed bronze or brushed black**. Bookcase always supplied in two separate parts
- Freistehendes Bücherregal, Seiten und Regale aus extrahellem Glas oder Rauchglas, die mit einer Bogen- oder Kreisstruktur aus **gebürsteter Bronze oder schwarz gebürstet** verbunden sind. Bücherregal immer in zwei Teilen geliefert.
- Bibliothèque autoportant composé de cotés et étagères en verre extra clair ou fumé joints avec une structure à arc ou cercle en **bronze brossé ou noir brossé**. Bibliothèque toujours fournis en deux parts.

	I E D F	dimensioni dimension abmessungen dimension	spessore thickness stärke épaisseur	volume volume volumen volume	carico ammesso admitted load tragfähigkeit charge admise	peso weight gewicht poids	prezzo price preis prix
		cm	mm	m3	kg	kg	euro

Penrose Consolle

design Isao Hosoe 2013
con Lucia Fontana e Masaya Hashimoto

120 x 48 x h 75

15

0,61

40

42

1.660

□ 1.780

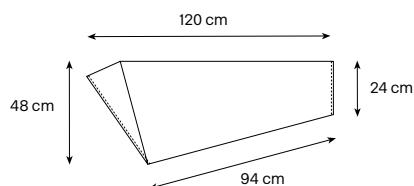
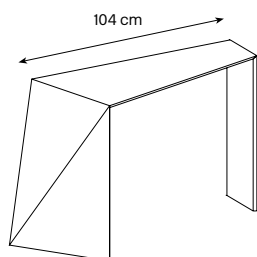

Vetro trasparente / transparent glass / Glas transparent / verre transparent

□ Vetro extrachiaro / extra clear glass / Glas extrahell / verre extra clair

- Consolle o scrittoio di forma irregolare. Disponibile in vetro trasparente o extrachiaro.
- Irregular shaped console or desk. Available in clear or extra clear glass.
- Konsole oder Schreibtisch in irregulärer Form. In Klarglas oder extrahellem Glas erhältlich.
- Console ou bureau de forme irrégulière. Disponible en verre clair ou extra clair.

Penrose Desk

design Isao Hosoe 2013
con Lucia Fontana e Masaya Hashimoto

185 x 78 x h 75

15

1,37

80

77

2.140

□ 2.380

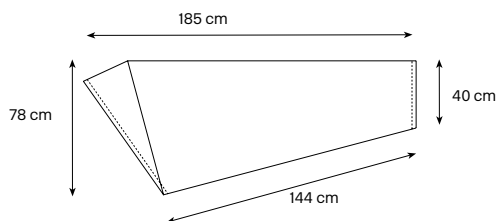
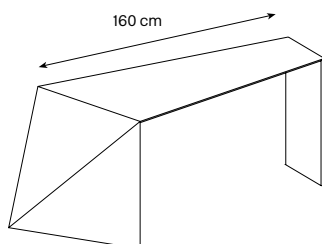

Vetro trasparente / transparent glass / Glas transparent / verre transparent

□ Vetro extrachiaro / extra clear glass / Glas extrahell / verre extra clair

- Scrivania di forma irregolare. Disponibile in vetro trasparente o extrachiaro.
- Irregular shaped desk. Available in clear or extra clear glass.
- Schreibtisch in irregulärer Form. In Klarglas oder extrahellem Glas erhältlich.
- Bureau en forme irrégulière. Disponible en verre clair ou extra clair.

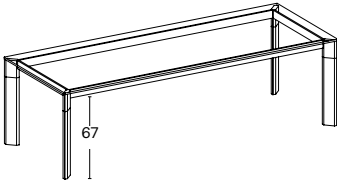
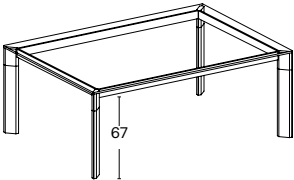
	I E D F	dimensioni dimension abmessungen dimension	spessore thickness stärke épaisseur	volume volume volumen volume	carico ammesso admitted load tragfähigkeit charge admise	peso weight gewicht poids	prezzo price preis prix
		cm	mm	m3	kg	kg	euro
Perseo design Paolo Grasselli 2015 		200 x 100 x h 76	15 / 38	0,57	150	144	● 3.480 ●● 3.340 ●●● 3.430 ●●●● 3.450
		220 x 100 x h 76	15 / 38	0,63	150	156	● 3.620 ●● 3.480 ●●● 3.570 ●●●● 3.590
		240 x 100 x h 76	15 / 38	0,69	150	168	● 3.840 ●● 3.700 ●●● 3.790 ●●●● 3.810
		260 x 100 x h 76	15 / 38	0,75	150	180	● 4.140 ●● 4.000 ●●● 4.090 ●●●● 4.110
		140 x 140 x h 76	15 / 38	0,56	150	142	● 3.450 ●● 3.310 ●●● 3.340 ●●●● 3.420
		160 x 160 x h 76	15 / 38	0,73	150	177	● 3.930 ●● 3.790 ●●● 3.880 ●●●● 3.710

- Gambe legno massello noce canaletto / Solid canaletto walnut legs
Pieds noyer canaletto bois massif / FüÙe in Massifholz Canaletto WalnuÙ
- Gambe bianche opaco / Matt white legs/ Pieds blanc opaque / FüÙe matt weiÙ
- Gambe RAL opaco/mat RAL legs / pieds RAL opaque / FüÙe matt RAL
- Gambe legno massello rovere naturale / Leg in solid natural oak
Bein aus massiver Natur Eiche / Pied en rouvre naturel massif.

- Tavolo rettangolare o quadrato in vetro extrachiaro. Gambe smontabili in legno massello noce canaletto e rovere naturale, bianco opaco o RAL.
- Dining table rectangular or square in extra clear glass. Demountable legs in solid walnut canaletto and natural oak, white matt or RAL.
- Hoher rechteckiger oder quadratischer Tisch aus extrahellem Glas. Demontierbare Beine aus massivem Holz, Walnuss canaletto oder Natur Eiche. Matt weiÙ oder RAL.
- Table haute rectangulaire ou carré en verre extra clair. Pieds amovibles en bois massif noyer canaletto ou rouvre naturel. Blanc mat ou RAL.

	I E D F	dimensioni dimension abmessungen dimension	spessore thickness stärke épaisseur	volume volume volumen volume	carico ammesso admitted load tragfähigkeit charge admise	peso weight gewicht poids	prezzo price preis prix
		cm	mm	m3	kg	kg	euro

Plinsky

design Giulio Mancini 2007/2019

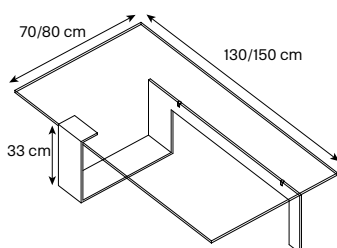

STRUTTURA VERNICIATA NERO / STRUCTURE BLACK LACQUERED / STRUKTUR SCHWARZ LACKIERT / STRUCTURE LAQUE NOIR

130 x 70 x h 33	12	0,42	30	60	1.390
					<input type="checkbox"/> 1.490
					■ 1.530
150 x 80 x h 33	12	0,45	30	69	1.480
					<input type="checkbox"/> 1.590
					■ 1.640

STRUTTURA VERNICIATA BIANCO / STRUCTURE WHITE LACQUERED / STRUKTUR WEISS LACKIERT / STRUCTURE LAQUE BLANC

130 x 70 x h 33	12	0,42	30	60	1.380
					<input type="checkbox"/> 1.480
					■ 1.520
150 x 80 x h 33	12	0,45	30	69	1.470
					<input type="checkbox"/> 1.580
					■ 1.630

STRUTTURA CROMATA / STRUCTURE CHROME / STRUKTUR CHROM / STRUCTURE CHROME

130 x 70 x h 33	12	0,42	30	60	1.440
					<input type="checkbox"/> 1.540
					■ 1.580
150 x 80 x h 33	12	0,45	30	69	1.530
					<input type="checkbox"/> 1.640
					■ 1.690

STRUTTURA CANNA DI FUCILE / GUNMETAL STRUCTURE / GUNMETAL STRUKTUR / STRUCTURE GUNMETAL

130 x 70 x h 33	12	0,42	30	60	1.890
					<input type="checkbox"/> 1.990
					■ 2.030
150 x 80 x h 33	12	0,45	30	69	1.980
					<input type="checkbox"/> 2.090
					■ 2.140

- Vetro extrachiaro / extra clear glass / extrahelles Glas / verre extra clair
 Vetro fumé / smoked glass / Rauchglas / verre fumé

- Tavolo basso in vetro trasparente, extrachiaro o fumé con basamento in metallo in finitura cromata o canna di fucile, verniciato nero o bianco opaco.
- Cocktail table in transparent, extra clear or smoked glass with metal base in chrome finish or gunmetal, matt black or white lacquered.
- Couchtisch in transparentem, extrahellem Glas oder Rauchglas mit Metallgestell aus Chrom oder Gunmetal, schwarz oder weiß matt lackiert.
- Table basse en verre transparent, extra clair ou fumé avec piètement en métal chromé ou gunmetal, laqué blanc ou noir mat.

	I E D F	dimensioni dimension abmessungen dimension	spessore thickness stärke épaisseur	volume volume volumen volume	carico ammesso admitted load tragfähigkeit charge admise	peso weight gewicht poids	prezzo price preis prix
		cm	mm	m3	kg	kg	euro

Psiche A

design G.T. Garattoni 2008/2019

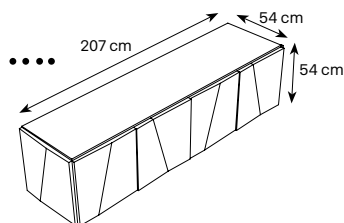
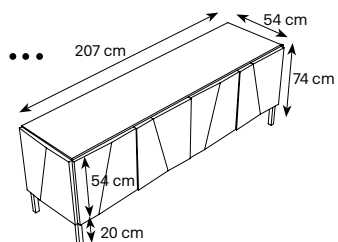
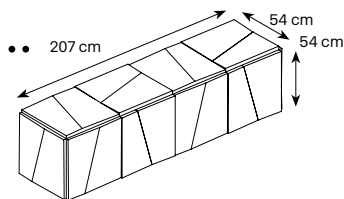
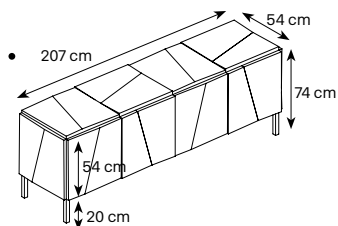

VETRI A SPECCHIO / MIRRORED GLASS / VERSPIEGELTES GLAS / MIROIR

207 x 54 x h 74	4	1,25		127	●	3.840
207 x 54 x h 54	4	1,25		127	●●	3.820
207 x 54 x h 74	4	1,25		127	●●●	3.300
207 x 54 x h 54	4	1,25		127	●●●●	3.280

VETRI A SPECCHIO FUMÉ O BRONZO / SMOKED OR BRONZE GLASS MIRROR RAUCHGLASSSPIEGEL ODER BRONZE SPIEGEL / VERRE EN MIROIR FUME OU BRONZE.

207 x 54 x h 74	4	1,25		127	●	3.970
207 x 54 x h 54	4	1,25		127	●●	3.950
207 x 54 x h 74	4	1,25		127	●●●	3.430
207 x 54 x h 54	4	1,25		127	●●●●	3.410

VETRI LACCATI BIANCHI / WHITE LACQUERED GLAS / WEISS LACKIERTES GLAS / VERRE LAQUÉ BLANC

207 x 54 x h 74	4	1,25		127	●	3.980
207 x 54 x h 54	4	1,25		127	●●	3.960
207 x 54 x h 74	4	1,25		127	●●●	3.440
207 x 54 x h 54	4	1,25		127	●●●●	3.420

**SPECIFICARE SEMPRE COLORE STRUTTURA: BIANCA O NERA / ALWAYS SPECIFY FRAME COLOUR: WHITE OR BLACK
IMMER FARBE DEK STRUKTUR ANGEBEN: WEISS ODER SCHWARZ / SPECIFIER TOUJOURS COULEUR STRUCTURE: BLANC OU NOIR**

- Versione standard con gambe / standard version with legs / standard Version mit Füßen / version standard avec pieds
- Versione sospeso / hanging version / Hängende Version / version suspendu
- Versione top liscio / straight top version / Version glatter top / version top droit
- Versione top liscio sospeso / Uplifted straight top version / Hängende Version und glatter Top version suspendu-top droit

Optional: 2 ripiani interni in vetro / 2 glass shelves / 2 Glas Platten / 2 étagères en verre

240

- Madia con struttura in legno bianca o nera, rivestita con vetri a specchio, specchio fumé o bronzo o vetro extrachiaro verniciato bianco.
- Sideboard with white or black wooden frame, covered by mirrored glass, smoked or bronze mirror or extra clear white lacquered glass.
- Sideboard mit Struktur aus weiß oder schwarz lackiertem Holz, verkleidet mit Glasspiegel, Rauchglasspiegel oder Bronze Spiegel oder mit extrahell weiß lackiertem Glas.
- Buffet avec structure en bois blanc ou noir, revêtit avec verre en miroir, miroir fumé ou bronze ou verre extra clair laqué blanc.

	I E D F	dimensioni dimension abmessungen dimension	spessore thickness stärke épaisseur	volume volume volumen volume	carico ammesso admitted load tragfähigkeit charge admise	peso weight gewicht poids	prezzo price preis prix
		cm	mm	m3	kg	kg	euro

Quiller tavolino

design Uto Balmoral 2016

90 x 90 x h 32	15	0,461	50	69	1.290
100 x 100 x h 32	15	0,558	50	76	1.480
120 x 120 x h 32	15	0,782	50	91	1.860
130 x 70 x h 40	15	0,604	50	75	1.360
150 x 80 x h 40	15	0,778	50	87	1.630

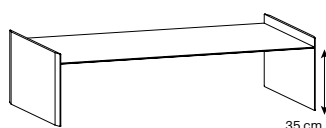
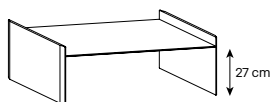

- Tavolo basso in vetro extrachiaro con bisellatura da 5cm. Disponibile in forma quadrata o rettangolare.
- Low table in extra clear glass with 5cm bevelling. Available square or rectangular.
- Niedriger Tisch in extrahellem Glas mit 5cm Schrägkante. Quadratisch oder rechteckig erhältlich.
- Table bas en verre extra clair avec biseautage de 5cm. Disponible carré ou rectangulaire.

Quiller side table

design Uto Balmoral 2016

A 50 x 50 x h 55	15	0,245	30	35	780
B 50 x 50 x h 55	15	0,245	30	44	970

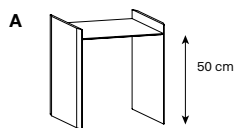

Vassoio in legno bianco opaco / **Tray** in matt white wood / **Holztablett** matt weiß / **Plateau** en blanc opaque

320

Vassoio in legno massello noce canaletto / **Tray** in solid walnut canaletto wood / **Holztablett** massiv Walnuss Canaletto / **Plateau** en noyer canaletto massif

390

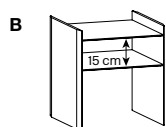

C 36 x 36 x h 43	15	0,127	30	21	590
------------------	----	-------	----	----	-----

"C" disponibile solo senza ripiano e senza vassoio / available only without shelf and without tray / nur ohne Fach und ohne Holztablett erhältlich / disponible seulement sans tablette et sans plateau

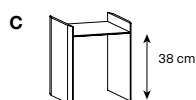

- Tavolino multiuso o comodo in vetro extrachiaro con bisellatura da 5cm. Disponibile con o senza ripiano. Optional vassoio in legno bianco opaco o legno massello noce canaletto.
- Multipurpose small table or bed side table in extra clear glass with 5cm bevelling. Available with or without shelf. Optional tray in matt white wood or solid walnut canaletto wood.
- Kleiner Mehrzwecktisch oder Nachttisch aus extrahellem Glas mit 5cm Schrägkante. Mit oder ohne Fach erhältlich Optionales Holztablett matt weiß oder massiv Walnuss Canaletto
- Petite table ou table de nuit en verre extra clair avec biseautage de 5cm. Disponible avec ou sans tablette. Optionnel plateau en bois blanc opaque ou noyer canaletto massif.

	I E D F	dimensioni dimension abmessungen dimension	spessore thickness stärke épaisseur	volume volume volumen volume	carico ammesso admitted load tragfähigkeit charge admise	peso weight gewicht poids	prezzo price preis prix
		cm	mm	m3	kg	kg	euro

Quiller console

120 x 45 x h 85

15

0,727

40

82

1.590

design Uto Balmoral 2016

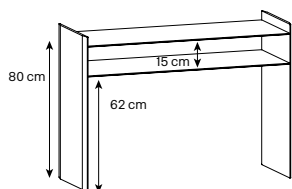

Vassoio in legno bianco opaco / **Tray** in matt white wood / **Holztablett** matt weiß / **Plateau** en blanc opaque

530

Vassoio in legno massello noce canaletto / **Tray** in solid walnut canaletto wood / **Holztablett** massiv Walnuss Canaletto / **Plateau** en noyer canaletto massif

650

- Consolle/scrivania in vetro extrachiario con bisellatura da 5cm. Optional vassoio in legno bianco opaco o legno massello noce canaletto.
- Console/desk in extra clear glass with 5cm bevelling. Optional tray in matt white wood or solid walnut canaletto wood.
- Konsoltisch in extrahellem Glas mit 5cm Schrägkante. Optionales Holztablett matt weiß oder massiv Walnuss canaletto.
- Console/bureau en verre extra clair avec biseautage de 5cm. Optionnel plateau en bois blanc opaque ou en noyer canaletto massif.

Quiller libreria

100 x 36 x h 200

15

1,156

* 25

152

2.960

design Uto Balmoral 2016

*ogni ripiano / on each shelf / auf jedem Bord / pour chaque étagère

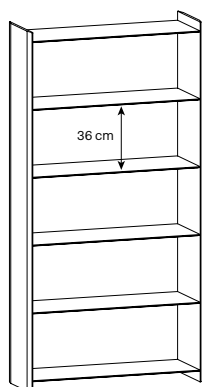

Su richiesta è possibile modificare lo spazio utile tra i ripiani
On demand the space between the shelves can be modified
Auf Anfrage kann das lichte Maß zwischen den Fächern geändert werden
Sur demande l'espace entre les étagères peut être modifié

- Libreria a sei ripiani in vetro extrachiario con bisellatura da 5cm, utilizzabile sia a parete che freestanding.
- Six shelves bookcase in extra clear glass with 5cm bevelling, can be also freestanding.
- Bücherregal mit 6 Fächern in extrahellem Glas und 5cm Schrägkante, kann gegen die Wand gestellt werden oder frei stehend.
- Bibliothèque à six étagères en verre extra clair avec biseautage de 5cm, utilisable au mur ou indépendant.

	I	dimensioni	spessore	volume	carico ammesso	peso	prezzo
	E	dimension	thickness	volume	admitted load	weight	price
	D	abmessungen	stärke	volumen	tragfähigkeit	gewicht	preis
	F	dimension	épaisseur	volume	charge admise	poids	prix
		cm	mm	m3	kg	kg	euro

Rosa del deserto

design D'Urbino - Lomazzi 1994

Ø 80 x h 38	12	0,31	30	48	1.350
					● 1.550
Ø 90 x h 38	12	0,33	30	54	1.380
					● 1.580
Ø 100 x h 38	12	0,35	30	61	1.420
					● 1.620

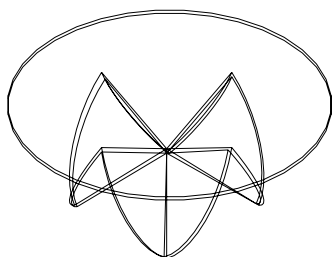

● Base acidata / frosted base / Untergestell aus geätzttem Glas / Base en verre mordancé

- Tavolino con basamento a due elementi accostabili. Disponibile con base acidata.
- Round coffee table with two approachable bases. Available also with base in frosted glass.
- Niedriger Tisch mit Gestell aus zwei anlehenden Elementen. Mit geätzttem Gestell verfügbar.
- Petite table avec piétement à deux éléments approchables. Disponible avec base mordancée.

Scala del cielo

design

De Pas-D'Urbino-Lomazzi 1988

A 120 x 24 x h 118	12	0,206	5*	26	1.270 □ 1.370
B 120 x 24 x h 118	12	0,206	5*	26	1.380 □ 1.480

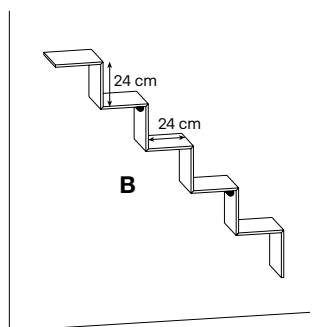
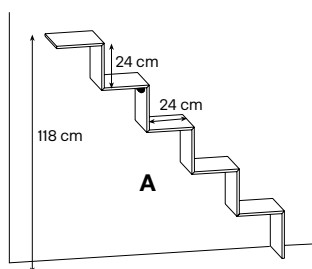

* ogni ripiano / on each shelf / auf jedem Bord / pour chaque étagère
 □ Vetro extrachiaro / extra clear glass / extrahelles Glas / verre extra clair

- A** - Porta oggetti con un sostegno a muro.
 - Object holder with 1 wall support.
 - Wandregal mit 1 Wandhalterung.
 - Etagère avec 1 support au mur.
- B** - Porta oggetti con due sostegni a muro.
 - Object holder with 2 wall support.
 - Wandregal mit 2 Wandhalterungen.
 - Etagère avec 2 supports au mur.

	I E D F	dimensioni dimension abmessungen dimension	spessore thickness stärke épaisseur	volume volume volumen volume	carico ammesso admitted load tragfähigkeit charge admise	peso weight gewicht poids	prezzo price preis prix
		cm	mm	m3	kg	kg	euro

Scenario

design Isao Hosoe 1989

90 x 52 x h 50	15	0,449	60	52	1.420
----------------	----	-------	----	----	-------

- Piano TV ellittico cm. 90 x 42 / Elliptical TV plate cm. 90 x 42
- Elliptische TV Platte cm. 90 x 42 / Plateau TV elliptique cm. 90 x 42

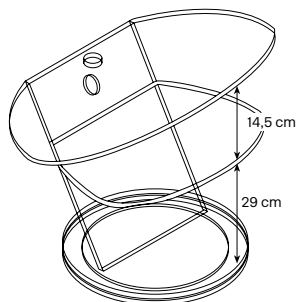

120 x 52 x h 50	15	0,559	70	55	1.480
-----------------	----	-------	----	----	-------

- Piano TV ellittico cm. 120 x 42 / Elliptical TV plate cm. 120 x 42
- Elliptische TV Platte cm. 120 x 42 / Plateau TV elliptique cm. 120 x 42

- Porta televisore su base rotante e ripiano inferiore.
- TV stand with double top on a revolving base.
- Fernsehständer mit doppelter Platte auf drehbarem Fuß.
- Table basse pour télévision avec double plateau sur base pivotante.

Secret

design M. U.

57 x 45 x h 47	12	0,255	40	38	● 1.040 □ 1.140 ■ 1.190
----------------	----	-------	----	----	-------------------------

●● 1.110 □ 1.210 ■ 1.260

●●● 1.120 □ 1.220 ■ 1.270

●●●● 1.130 □ 1.230 ■ 1.280

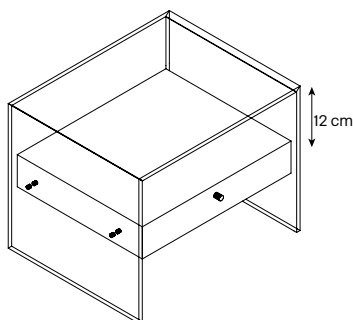

- Laccato nero o bianco opaco / matt lacquered black or white / matt schwarz oder weiß / noir ou blanc mat
- Eucalipto / Eucalipto / Eucalipto / Eucalipto
- Siberian Ash/ Siberian Ash / Siberian Ash / Siberian Ash
- Noce canaletto/ canaletto walnut / Walnuß Canaletto/ noyer canaletto

- Vetro extrachiaro / extra clear glass / extrahelles Glas / verre extra clair
- Vetro fumé / smoked glass / Rauchglas / verre fumé

- Comodino in vetro trasparente, extra chiaro o fumé. Cassetto disponibile in Eucalipto, Siberian Ash, noce canaletto, laccato nero o bianco opaco.
- Bed side table in transparent, extra clear or smoked glass. Drawer available in Eucalipto, Siberian Ash, Canaletto walnut, matt lacquered black or white.
- Nachttisch aus transparentem, extrahellem Glas oder Rauchglas. Schublade in Eucalipto, Siberian Ash, Walnuß Canaletto, matt schwarz oder weiß.
- Table de nuit en verre transparent, extra clair ou fumé. Tiroir en Eucalipto, Siberian Ash, noyer canaletto, noir ou blanc mat.

	I E D F	dimensioni dimension abmessungen dimension	spessore thickness stärke épaisseur	volume volume volumen volume	carico ammesso admitted load tragfähigkeit charge admise	peso weight gewicht poids	prezzo price preis prix
		cm	mm	m3	kg	kg	euro

Sestante

design Emilio Nanni 2019

120 x 40 x h 72	12 10	0,55	40	67	<input type="checkbox"/> 1.040 <input checked="" type="checkbox"/> 1.110 <input type="checkbox"/> 1.220 <input checked="" type="checkbox"/> 1.550
150 x 40 x h 72	12 10	0,68	40	80	<input type="checkbox"/> 1.220 <input checked="" type="checkbox"/> 1.270 <input type="checkbox"/> 1.340 <input checked="" type="checkbox"/> 1.750

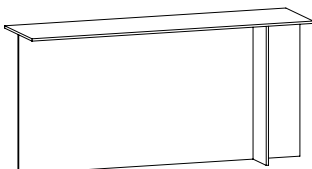

- Vetro extrachiaro / extra clear glass / extrahelles Glas / verre extra clair
- Vetro fumé / smoked glass / Rauchglas / verre fumé
- Vetro bronzo / bronze glass / Bronze Glas / Verre bronze
- vetro extrachiaro decorato / extra clear decorated glass / extrahelles Dekorglas / verre extra clair avec décor

- Consolle in vetro extrachiaro, fumé, bronzo o vetro extrachiaro con decoro in stampa digitale.
 - Console in extra clear, smoked, bronze glass or extra clear glass with digital printing decoration.
 - Konsole aus extrahellem Glas, Rauchglas, Bronze Glas, oder extrahellem Glas mit Digitaldruckdekor.
 - Console en verre extra clair, fumé, bronze ou extra clair avec décor en impression digitale.

Sestante

design Emilio Nanni 2019

150 x 40 x h 42	12 10	0,45	120	62	<input type="checkbox"/> 1.080 <input checked="" type="checkbox"/> 1.130 <input type="checkbox"/> 1.240 <input checked="" type="checkbox"/> 1.520
-----------------	----------	------	-----	----	--

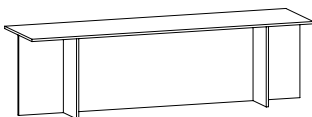

- Vetro extrachiaro / extra clear glass / extrahelles Glas / verre extra clair
- Vetro fumé / smoked glass / Rauchglas / verre fumé
- Vetro bronzo / bronze glass / Bronze Glas / Verre bronze
- vetro extrachiaro decorato / extra clear decorated glass / extrahelles Dekorglas / verre extra clair avec décor

- Panca in vetro extrachiaro, fumé, bronzo o vetro extrachiaro con decoro in stampa digitale.
 - Bench in extra clear, smoked, bronze or extra clear glass with digital printing decoration.
 - Bank aus extrahellem Glas, Rauchglas, Bronze Glas oder extrahellem Glas mit Digitaldruckdekor.
 - Banquette en verre extra clair, fumé, bronze ou verre extra clair avec décor en impression digitale.

Sestante

design Emilio Nanni 2019

100 x 100 x h 36	12 10	0,61	30	70	<input type="checkbox"/> 1.110 <input checked="" type="checkbox"/> 1.160 <input type="checkbox"/> 1.270 <input checked="" type="checkbox"/> 1.620
130 x 70 x h 36	12 10	0,56	30	67	<input type="checkbox"/> 1.070 <input checked="" type="checkbox"/> 1.120 <input type="checkbox"/> 1.230 <input checked="" type="checkbox"/> 1.540
150 x 100 x h 36	12 10	0,89	30	97	<input type="checkbox"/> 1.440 <input checked="" type="checkbox"/> 1.510 <input type="checkbox"/> 1.660 <input checked="" type="checkbox"/> 2.170
150 x 150 x h 36	12 10	1,29	30	127	<input type="checkbox"/> 1.840 <input checked="" type="checkbox"/> 1.920 <input type="checkbox"/> 2.110 <input checked="" type="checkbox"/> 2.910
150 x 40 x h 42	12 10	0,45	30	56	<input type="checkbox"/> 970 <input checked="" type="checkbox"/> 1.010 <input type="checkbox"/> 1.110 <input checked="" type="checkbox"/> 1.370



- Vetro extrachiaro / extra clear glass / extrahelles Glas / verre extra clair
- Vetro fumé / smoked glass / Rauchglas / verre fumé
- Vetro bronzo / bronze glass / Bronze Glas / Verre bronze
- vetro extrachiaro decorato / extra clear decorated glass / extrahelles Dekorglas / verre extra clair avec décor

- Tavolo basso in vetro extrachiaro, fumé, bronzo, o vetro extrachiaro con decoro in stampa digitale. Disponibile in 5 misure.
 - Low table in extra clear, smoked, bronze or extra clear glass with digital printing decoration. Available in 5 sizes.
 - Couchtisch aus extrahellem Glas, Rauchglas, Bronze Glas oder extrahellem Glas mit Digitaldruckdekor.
 In 5 verschiedenen Maßen erhältlich.
 - Table bas en extra clair, verre fumé, bronze ou verre extra clair avec décor en impression digitale. Disponible en 5 mesures.

	I	dimensioni	spessore	volume	carico ammesso	peso	prezzo
	E	dimension	thickness	volume	admitted load	weight	price
	D	abmessungen	stärke	volumen	tragfähigkeit	gewicht	preis
	F	dimension	épaisseur	volume	charge admise	poids	prix
		cm	mm	m3	kg	kg	euro

Sestante_Stone

design Emilio Nanni 2020

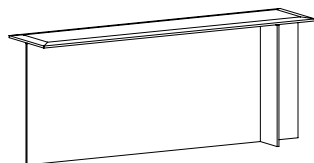

120 x 40 x h 73	12 / 20	0,55	40	80	△ 1.980 △△ 2.590 △△△ 3.060	▲ 2.020 ▲▲ 2.630 ▲▲▲ 3.100
150 x 40 x h 73	12 / 20	0,68	40	96	△ 2.370 △△ 3.080 △△△ 3.630	▲ 2.420 ▲▲ 3.130 ▲▲▲ 3.680
180 x 40 x h 73	12 / 20	0,81	40	112	△ 2.730 △△ 3.550 △△△ 4.220	▲ 2.790 ▲▲ 3.610 ▲▲▲ 4.280
130 x 70 x h 37	12	0,56	30	90	△ 2.540 △△ 3.370 △△△ 4.070	▲ 2.560 ▲▲ 3.390 ▲▲▲ 4.090
100 x 100 x h 37	12 / 20	0,61	30	96	△ 2.630 △△ 3.490 △△△ 4.230	▲ 2.650 ▲▲ 3.510 ▲▲▲ 4.250
150 x 100 x h 37	12 / 20	0,89	30	136	△ 3.460 △△ 4.670 △△△ 5.680	▲ 3.500 ▲▲ 4.710 ▲▲▲ 5.720
150 x 150 x h 37	12 / 20	1,29	30	185	△ 4.580 △△ 6.170 △△△ 7.560	▲ 4.630 ▲▲ 6.220 ▲▲▲ 7.610
150 x 40 x h 43	12 / 20	0,45	30	72	△ 2.180 △△ 2.880 △△△ 3.440	▲ 2.210 ▲▲ 3.910 ▲▲▲ 3.470

△ base vetro extrachiaro, top marmo Arabescato Orobico Gold
extra clear base, top in Arabescato Orobico Gold marble
Gestell aus extrahellem Glas, Top in Marmor Arabescato Orobico Gold
base en verre extra clair, top en marbre Arabescato Orobico Gold

△△ base vetro extrachiaro, top marmo Tropikal Storm
extra clear base, top in Tropikal Storm marble
Gestell aus extrahellem Glas, Top in Marmor Tropikal Storm
base en verre extra clair, top en marbre Tropikal Storm

△△△ base vetro extrachiaro, top marmo Domus White
base en verre extra clair, top in Domus White marble
Gestell aus extrahellem Glas, Top in Marmor Domus White
base en verre extra clair, top en marbre Domus White

▲ base vetro fumè, top marmo Arabescato Orobico Gold
base in smoked glass, top in Arabescato Orobico Gold marble
Gestell aus Rauchglas, Top in Marmor Arabescato Orobico Gold
base en verre fumé, top en marbre Arabescato Orobico Gold

▲▲ base vetro fumè, top marmo Tropikal Storm
base in smoked glass, top in Tropikal Storm marble
Gestell aus Rauchglas, Top in Marmor Tropikal Storm
base en verre fumé, top en marbre Tropikal Storm

▲▲▲ base vetro fumè, top marmo Domus White
base in smoked glass, top in Domus White marble
Gestell aus Rauchglas, Top in Marmor Domus White
base en verre fumé, top en marbre Domus White

- Consolle o tavolo basso. Base in vetro fumè o extrachiaro.
Top in marmo bisellato, disponibile in Arabescato Orobico Gold, Tropikal Storm o Domus white
- Console or low table. Base in smoked or extra clear glass.
Top in bevelled marble, available in Arabescato Orobico Gold, Tropikal Storm or Domus White.
- Konsole oder Couchtisch. Gestell aus Rauchglas oder extrahellem Glas.
Top in Marmor mit Facettenschliff, erhältlich in Arabescato Orobico Gold, Tropikal Storm oder Domus White.
- Consolle ou table bas. Base en verre fumé ou extra clair.
Top en marbre biseauté, disponible en Arabescato Orobico Gold, Tropikal Storm ou Domus White.

	I E D F	dimensioni dimension abmessungen dimension	spessore thickness stärke épaisseur	volume volume volumen volume	carico ammesso admitted load tragfähigkeit charge admise	peso weight gewicht poids	prezzo price preis prix
		cm	mm	m3	kg	kg	euro

Sestante

design Emilio Nanni 2023

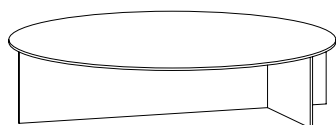

Ø 80 x h 30	10	0,36	30	45	<input type="checkbox"/> 1.000 <input checked="" type="checkbox"/> 1.030 <input type="checkbox"/> 1.130
Ø 80 x h 36	10	0,41	30	48	<input type="checkbox"/> 1.040 <input checked="" type="checkbox"/> 1.080 <input type="checkbox"/> 1.180
Ø 100 x h 30	10	0,54	30	58	<input type="checkbox"/> 1.170 <input checked="" type="checkbox"/> 1.210 <input type="checkbox"/> 1.330
Ø 100 x h 36	10	0,62	30	62	<input type="checkbox"/> 1.210 <input checked="" type="checkbox"/> 1.250 <input type="checkbox"/> 1.380
Ø 130 x h 30	10	0,88	30	79	<input type="checkbox"/> 1.570 <input checked="" type="checkbox"/> 1.630 <input type="checkbox"/> 1.790
Ø 130 x h 36	10	1,00	30	83	<input type="checkbox"/> 1.620 <input checked="" type="checkbox"/> 1.690 <input type="checkbox"/> 1.860
Ø 150 x h 30	10	1,15	30	96	<input type="checkbox"/> 1.860 <input checked="" type="checkbox"/> 1.940 <input type="checkbox"/> 2.130
Ø 150 x h 36	10	1,3	30	100	<input type="checkbox"/> 1.920 <input checked="" type="checkbox"/> 2.010 <input type="checkbox"/> 2.210

- basamento e piano extrachiaro / extra clear base and top
Gestell und Tischplatte extrahell / piètement et top extra clair
- basamento e piano fumè / smoked base and top
Gestell und Tischplatte aus Rauchglas / piètement et top fumé
- basamento e piano bronzo / bronze base and top
Gestell und Tischplatte aus Bronze Glas / piètement et top bronze

- Tavolo basso o fianco divano in vetro extrachiaro, fumè o bronzo.
 - Low table or side table in extra clear, smoked or bronze glass.
 - Couchtisch oder Beistelltisch aus extrahellem Glas, Rauchglas oder Bronze Glas.
 - Table bas ou table de chevet verre en extra clair, fumé ou bronze.

Sestante

design Emilio Nanni 2023

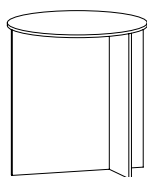

Ø 50 x h 42	10	0,2	20	24	<input type="checkbox"/> 630 <input checked="" type="checkbox"/> 660 <input type="checkbox"/> 730
Ø 50 x h 54	10	0,22	20	29	<input type="checkbox"/> 690 <input checked="" type="checkbox"/> 720 <input type="checkbox"/> 790

- basamento e piano extrachiaro / extra clear base and top
Gestell und Tischplatte extrahell / piètement et top extra clair
- basamento e piano fumè / smoked base and top
Gestell und Tischplatte aus Rauchglas / piètement et top fumé
- basamento e piano bronzo / bronze base and top
Gestell und Tischplatte aus Bronze Glas / piètement et top bronze

- Tavolo basso o fianco divano in vetro extrachiaro, fumè o bronzo.
 - Low table or side table in extra clear, smoked or bronze glass.
 - Couchtisch oder Beistelltisch aus extrahellem Glas, Rauchglas oder Bronze Glas.
 - Table bas ou table de chevet verre en extra clair, fumé ou bronze.

	I E D F	dimensioni dimension abmessungen dimension	spessore thickness stärke épaisseur	volume volume volumen volume	carico ammesso admitted load tragfähigkeit charge admise	peso weight gewicht poids	prezzo price preis prix
		cm	mm	m3	kg	kg	euro

Sestante

design Emilio Nanni 2023



130 x 70 x h 30	10	0,50	30	60	<input type="checkbox"/> 1.150 <input checked="" type="checkbox"/> 1.190 <input type="checkbox"/> 1.310
130 x 70 x h 36	10	0,57	30	64	<input type="checkbox"/> 1.200 <input checked="" type="checkbox"/> 1.250 <input type="checkbox"/> 1.380
150 x 80 x h 30	10	0,65	30	74	<input type="checkbox"/> 1.370 <input checked="" type="checkbox"/> 1.430 <input type="checkbox"/> 1.570
150 x 80 x h 36	10	0,73	30	78	<input type="checkbox"/> 1.420 <input checked="" type="checkbox"/> 1.490 <input type="checkbox"/> 1.640
200 x 70 x h 30	10	0,76	30	85	<input type="checkbox"/> 1.650 <input checked="" type="checkbox"/> 1.730 <input type="checkbox"/> 1.900
200 x 70 x h 36	10	0,86	30	90	<input type="checkbox"/> 1.710 <input checked="" type="checkbox"/> 1.800 <input type="checkbox"/> 1.980

- basamento e piano extrachiaro / extra clear base and top
Gestell und Tischplatte extrahell / piètement et top extra clair
- basamento e piano fumè / smoked base and top
Gestell und Tischplatte aus Rauchglas / piètement et top fumé
- basamento e piano bronzo / bronze base and top
Gestell und Tischplatte aus Bronze Glas / piètement et top bronze

- Tavolo basso o fianco divano in vetro extrachiaro, fumè o bronzo.
- Low table or side table in extra clear, smoked or bronze glass.
- Couchtisch oder Beistelltisch aus extrahellem Glas, Rauchglas oder Bronze Glas.
- Table bas ou table de chevet verre en extra clair, fumé ou bronze.

	I E D F	dimensioni dimension abmessungen dimension	spessore thickness stärke épaisseur	volume volume volumen volume	carico ammesso admitted load tragfähigkeit charge admise	peso weight gewicht poids	prezzo price preis prix
		cm	mm	m3	kg	kg	euro

She

53 x 56 x h 80

0,404

11

design Massimo Castagna 2021

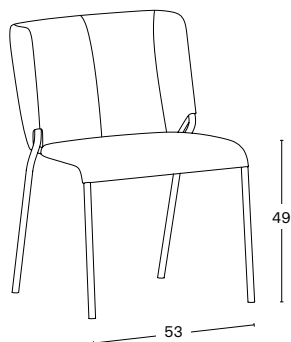

FINITURA STRUTTURA / STRUCTURE FINISH STRUKTURAUSFÜHRUNG / FINITION STRUCTURE	SEDUTA-SCHIENALE / SEAT-BACKREST / SITZ-SITZLEHNE / ASSISE-DOSSIER			
VERNICIATA / LACQUERED LACKIERT / LACQUÉE	TESSUTO P / FABRIC P STOFF P / TISSU P	TESSUTO F / FABRIC F STOFF F / TISSU F	ECOPELLE / FAUX LEATHER ÖKOLEDER / ÉCO-CUIR	PELLE / LEATHER LEDER / CUIR
nero / black / schwarz / noir	690	730	740	890
grigio antracite / anthracite grey Anthrazit grau / gris anthracite	690	730	740	890
bianco / white / weiß / blanc	690	730	740	890
CROMATO / CHROME CHROM / CHROME				
cromo lucido / polished chrome Chrom glänzend / chrome brillant	730	770	780	930
canna di fucile lucido / polished gunmetal Gunmetal glänzend / gunmetal brillant	740	780	790	940

Finiture pelle, ecopelle e tessuti vedi catalogo 2023 pag. 347-348-349
 Leather, faux leather and fabrics finishes see catalogue 2023 pages 347-348-349
 Verfügbare Leder, Ökoleder und Stoffe siehe Katalog 2023 Seiten 347-348-349
 Finitions cuir, éco-cuir et tissus voire catalogues 2023 pages 347-348-349

- Sedia con struttura in tubolare da 20 mm in finiture cromo lucido, canna di fucile lucido o verniciate gofrato opaco. Sedile e schienale imbottito, rivestito in pelle, ecopelle o tessuto F o P. Sedia non sfoderabile.
- chair with 20 mm tubular structure in polished chrome, polished gunmetal or matt embossed lacquered finish. Upholstered seat and backrest in leather, eco-leather or fabric F or P. Covering not removable.
- Stuhl mit 20 mm rohrförmigen Struktur in Ausführung Chrom glänzend, Gunmetal glänzend oder matt eingepprägter Lackierung. Gepolsterter Sitz und Sitzlehne aus Leder, Ökoleder oder Stoffbezug F oder P. Stuhlbekleidung nicht abziehbar.
- chaise avec structure tubulaire en 20 mm en finitions chrome brillant, gunmetal brillant ou laqué mat gaufré. Assise et dossier rembourrés en cuir, éco-cuir ou tissu F ou P. Chaise pas déhoussable.

	I E D F	dimensioni dimension abmessungen dimension	spessore thickness stärke épaisseur	volume volume volumen volume	carico ammesso admitted load tragfähigkeit charge admise	peso weight gewicht poids	prezzo price preis prix
		cm	mm	m3	kg	kg	euro
Shiki 40/60/80 design Isao Hosoe 2010/2011		40 + 29 x h 40	4	0,05		13	780
		60 + 43 x h 60	4	0,12		20	960
		80 + 57 x h 80	4	0,17		42	1.190

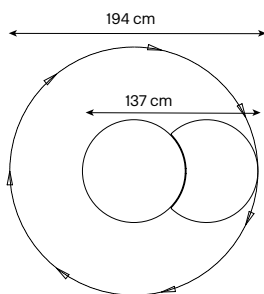
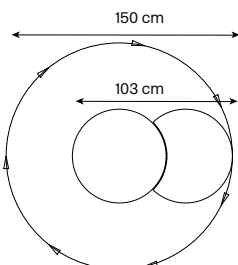
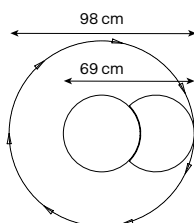
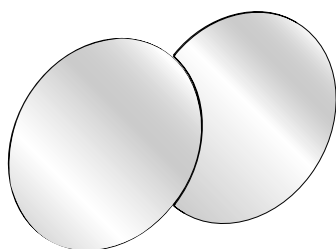

- Specchio da parete con parte fissa e satellite che ruota a 360°. Disponibile in tre dimensioni.
- Wall mirror with fix part and satellite turning at 360°. Available in three dimensions.
- Wandspiegel mit fixem Teil und 360° drehender Satellit. In drei Größen erhältlich.
- Miroir au mur avec partie fixe et satellite tournant à 360°. Disponible en trois dimensions.

	I E D F	dimensioni dimension abmessungen dimension	spessore thickness stärke épaisseur	volume volume volumen volume	carico ammesso admitted load tragfähigkeit charge admise	peso weight gewicht poids	prezzo price preis prix
		cm	mm	m3	kg	kg	euro

Shoji cabinet

design Studio Hosoe e
Lorenzo De Bartolomeis 2019

C1

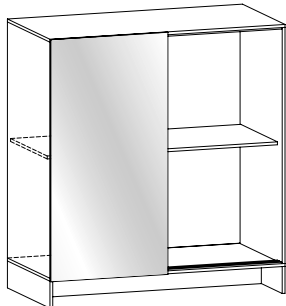

C1 - 100 x 50 x h 110	10/12	1,02	80/*15	185	□ 2.970
					■ 3.130

- Maggiorazione per finitura **top** in ceramica / supplement for ceramic **top**
Aufpreis für **Top** aus Keramik / supplément pour **top** en céramique. 360

- Maggiorazione per finitura **anta** in ceramica/ supplement for **door** in ceramic
Aufpreis für **Tür** aus Keramik / supplément pour **porte** en céramique. 160

- Maggiorazione per finitura **schienale** in ceramica / supplement for **back panel** in ceramic
Aufpreis für **Rückwand** aus Keramik / supplément pour **dos** en céramique. 630

C2

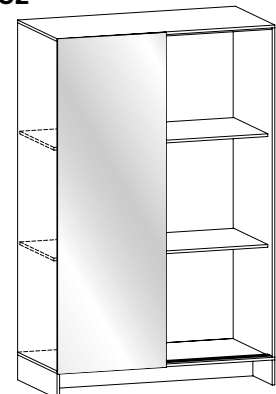

C2 - 100 x 50 x h 160	10/12	1,47	80/*15	245	□ 3.740
					■ 3.940

- Maggiorazione per finitura **top** in ceramica / supplement for ceramic **top**
Aufpreis für **Top** aus Keramik / supplément pour **top** en céramique. 360

- Maggiorazione per finitura **anta** in ceramica/ supplement for **door** in ceramic
Aufpreis für **Tür** aus Keramik / supplément pour **porte** en céramique. 260

- Maggiorazione per finitura **schienale** in ceramica / supplement for **back panel** in ceramic
Aufpreis für **Rückwand** aus Keramik / supplément pour **dos** en céramique. 930

* ogni ripiano / on each shelf / auf jedem Bord / pour chaque étagère

□ **Struttura vetro extrachiaro, anta a specchio** / extra clear glass structure, mirror door
extrahelle Struktur, Spiegeltür / structur verre extra clair, porte en miroir

■ **Struttura vetro fumè, anta a specchio fumè o bronzo** / smoked structure, smoked or bronze mirror door
Struktur aus Rauchglas, Tür aus Bronze- oder Rauchspiegel / structur en verre fumé, porte en miroir fumé ou bronze

- **Specificare sempre la finitura dell'anta a specchio** / always specify door finish
immer Ausführung der Tür angeben / spécifier toujours finition porte.

C



C Optional cassetiera in legno impiallacciato noce canaletto / optional chest of drawers in veneer
wood walnut canaletto / Optional Schubladenelement aus Furnierholz Canaletto Walnuß
option caisson à tiroir en bois plaqué noyer canaletto. 870

C optional cassetiera in legno impiallacciato Siberian Ash o Eucalpto 880
optional drawer unit in veneer Siberian Ash or Eucalpto
optionales Schubladenelement aus furniertem Holz Siberian Ash oder Eucalpto
option caisson à tiroir en bois plaqué Siberian Ash ou Eucalpto

C Optional cassetiera RAL opaco / optional chest of drawers matt RAL 860
optionales Schubladenelement matt RAL/ option caisson à tiroir RAL mat.

- Madia disponibile in due altezze in vetro extrachiaro o fumè. Anta scorrevole in finitura specchio.
Top, schienale e anta scorrevole disponibili in ceramica: **Pietra di Savoia antracite bocciardato, Noir desir lucido o opaco, Emperador lucido o opaco, Calacatta oro venato lucido, Pietra Grey lucido o opaco, Sahara noir lucido o bocciardato.**
Optional fino ad un massimo di 6 cassetiere in noce canaletto, Siberian Ash, Eucalpto o RAL opaco.

- Cabinet available in two heights in extra clear or smoked glass. Sliding door in mirror finish.
Top, back and sliding door available in ceramic: **Pietra di Savoia antracite bocciardato, Noir desir polished or matt, Emperador polished or matt, Calacatta oro venato polished, Pietra Grey polished or matt, Sahara noir polished or bocciardato.**
Optional drawer units, max.6 pcs, in walnut canaletto, Siberian Ash, Eucalpto or RAL matt.

- Anrichte in zwei Höhen aus extrahellem Glas oder Rauchglas. Schiebetür verspiegelt.
Optional Schubladenelemente, bis zu maximal 6 Stück, aus Walnuß canaletto, Siberian Ash, Eucalpto oder matt RAL.

- Armoire disponible en deux hauteurs en verre extra clair ou fumé. Porte coulissante en miroir.
Top, dos et porte coulissante sont disponible en céramique: **Pietra di Savoia anthracite mat, Noir desir brillant ou mat, Emperador brillant ou mat, Calacatta oro venato brillant, Pietra grey brillant ou mat, Sahar noir brillant ou bocciardato.**
Option caisson à tiroir, maximum 6 pièces, en noyer canaletto, Siberian Ash, Eucalpto ou RAL mat.

	I	dimensioni	spessore	volume	carico ammesso	peso	prezzo
	E	dimension	thickness	volume	admitted load	weight	price
	D	abmessungen	stärke	volumen	tragfähigkeit	gewicht	preis
	F	dimension	épaisseur	volume	charge admise	poids	prix
		cm	mm	m3	kg	kg	euro

Shoji cabinet

design Studio Hosoe e
Lorenzo De Bartolomeis 2019

C3 - 100 x 50 x h 160	10/12	1,47	80/*15	231	<input type="checkbox"/> 3.970
					<input checked="" type="checkbox"/> 4.180

C3

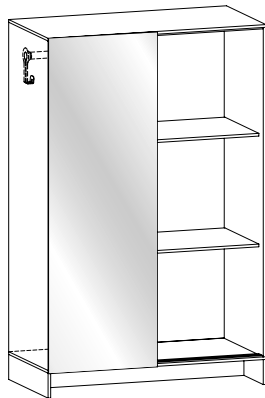

- Maggiorazione per finitura **top** in ceramica / supplement for ceramic **top**
Aufpreis für **Top** aus Keramik / supplément pour **top** en céramique. 360
- Maggiorazione per finitura **anta** in ceramica/ supplement for **door** in ceramic
Aufpreis für **Tür** aus Keramik / supplément pour **porte** en céramique. 260
- Maggiorazione per finitura **schienale** in ceramica / supplement for **back panel** in ceramic
Aufpreis für **Rückwand** aus Keramik / supplément pour **dos** en céramique. 930

* ogni ripiano / on each shelf / auf jedem Bord / pour chaque étagère

- Struttura vetro extrachiaro, anta a specchio** / extra clear glass structure, mirror door
extrahelle Struktur, Spiegeltür / structur verre extra clair, porte en miroir
- Struttura vetro fumè, anta a specchio fumè o bronzo** / smoked structure, smoked or bronze mirror door
Struktur aus Rauchglas, Tür aus Bronze- oder Rauchspiegel / structur en verre fumé, porte en miroir fumé ou bronze
- **Specificare sempre la finitura dell'anta a specchio** / always specify door finish
immer Ausführung der Tür angeben / spécifier toujours finition porte.

C

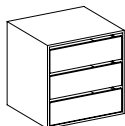

- C** Optional cassettiera in legno impiallacciato noce canaletto / optional chest of drawers in veneer wood walnut canaletto / Optional Schubladenelement aus Furnierholz Canaletto Walnutß option caisson à tiroir en bois plaqué noyer canaletto. 870
- C** optional cassettiera in legno impiallacciato Siberian Ash o Eucapilto
optional drawer unit in veneer Siberian Ash or Eucapilto
optionales Schubladenelement aus furniertem Holz Siberian Ash oder Eucapilto
option caisson à tiroir en bois plaqué Siberian Ash ou Eucapilto 880
- C** Optional cassettiera RAL opaco / optional chest of drawers matt RAL
optionales Schubladenelement matt RAL/ option caisson à tiroir RAL mat. 860

- Madia con asta appendiabiti in vetro extrachiaro o fumè. Anta scorrevole in finitura specchio.
Top, schienale e anta scorrevole disponibili in ceramica: **Pietra di Savoia opaco antracite, Noir Desir lucido o opaco, Emperador lucido o opaco, Calacatta oro venato lucido, Pietra Grey lucido o opaco, Sahara noir lucido o bocciardato.**
Optional fino ad un massimo di 3 cassettiere in noce canaletto, Siberian Ash, Eucapilto o RAL opaco.
- Cabinet in extra clear or smoked glass with coat hanger rod. Sliding door in mirror finish.
Top, back and sliding door available in ceramic: **Pietra di Savoia antracite bocciardato, Noir desir polished or matt, Emperador polished or matt, Calacatta oro venato polished, Pietra Grey polished or matt, Sahara noir polished or bocciardato.**
Optional drawer units, maximum 3 pcs., in walnut canaletto, Siberian Ash, Eucapilto or RAL matt.
- Schrank aus extrahellem Glas oder Rauchglas mit Kleiderstab. Schiebetür verpiegelt.
Top, Rückwand und Schiebetür in Keramik erhältlich: **Pietra di Savoia Anthrazit matt, Noir Desir glänzend oder matt, Emperador glänzend oder matt, guilochierte Calacatta glänzend und grau Orobico glänzend.**
Optionale Schubladenelemente bis zu maximal 3 Stück aus Canaletto Walnutß, Siberian Ash, Eucapilto oder matt RAL.
- Armoire en verre extra clair ou fumé avec bâton porte-manteau. Porte coulissante en miroir.
Top, dos et porte coulissante disponibles en céramique: **Pietra di Savoia anthracite mat, Noir Desir brillant ou mat, Emperador brillant ou mat, Calcatta arabesque brillant et gris Orobico brillant.**
Option caisson à tiroir, maximum 3 pièces, en noyer Canaletto, Siberian Ash, Eucapilto ou RAL mat.

	I E D F	dimensioni dimension abmessungen dimension	spessore thickness stärke épaisseur	volume volume volumen volume	carico ammesso admitted load tragfähigkeit charge admise	peso weight gewicht poids	prezzo price preis prix
		cm	mm	m3	kg	kg	euro

Shoji cabinet Wood design Studio Hosoe e Lorenzo De Bartolomeis 2019/2020	C1 100 x 50 x h 110	10/12	1,02	80/*15	185	<input type="checkbox"/> 3.220
						<input checked="" type="checkbox"/> 3.380

C1

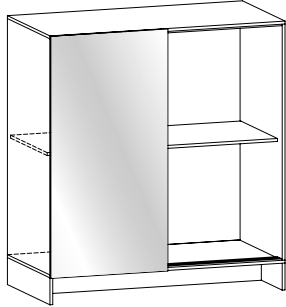

Specificare sempre la finitura dell'anta in legno Siberian Ash o Eucalipto
Always specify finish of wood door Siberian Ash or Eucalipto
Immer Ausführung der Holztür angeben Siberian Ash oder Eucalipto
Indiquer toujours finition de la porte en bois Siberian Ash ou Eucalipto

* ogni ripiano / each shelf / jedes Fach chaque étagère

- struttura vetro extrachiaro / extra clear glass structure / extrahelle Struktur / structure verre extra clair
 struttura vetro fumè / smoked structure / Struktur aus Rauchglas / structure en verre fumé

C2 100 x 50 x h 160	10/12	1,47	80/*15	245	<input type="checkbox"/> 4.080
					<input checked="" type="checkbox"/> 4.280

C2

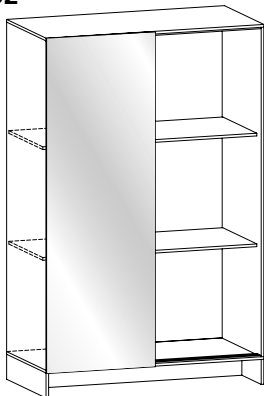

Specificare sempre la finitura dell'anta in legno Siberian Ash o Eucalipto
Always specify finish of wood door Siberian Ash or Eucalipto
Immer Ausführung der Holztür angeben Siberian Ash oder Eucalipto
Indiquer toujours finition de la porte en bois Siberian Ash ou Eucalipto

* ogni ripiano / each shelf / jedes Fach chaque étagère

- struttura vetro extrachiaro / extra clear glass structure / extrahelle Struktur / structure verre extra clair
 struttura vetro fumè / smoked structure / Struktur aus Rauchglas / structure en verre fumé

C



C
optional cassetiera in legno impiallacciato Siberian Ash o Eucalipto 880
optional drawer unit in veneer Siberian Ash or Eucalipto
optionales Schubladenelement aus furniertem Holz Siberian Ash oder Eucalipto
option caisson à tiroir en bois plaqué Siberian Ash ou Eucalipto

C
optional cassetiera in legno laccato RAL opaco 860
optional wooden matt RAL lacquered drawer unit
optionales Schubladenelement aus Holz matt RAL lackiert
option caisson à tiroir en bois laqué RAL mat

Specificare sempre la finitura della cassetiera / always specify finish of drawer unit
immer Ausführung des Schubladenelement angeben / toujours spécifier finition caisson à tiroir

- Cabinet disponibile in due altezze in vetro extrachiaro o fumè. Anta scorrevole in legno (Siberian Ash o Eucalipto).
Optional fino ad un massimo di 4/6 cassetiere in legno (Siberian Ash o Eucalipto) o laccato RAL opaco.
- Cabinet available in two heights in extra clear or smoked glass. Sliding door in wood (Siberian Ash or Eucalipto).
Optional drawer unit, up to maximum 4/6, in wood (Siberian Ash or Eucalipto) or matt RAL lacquered.
- Schrank in zwei Höhen aus extrahellem Glas oder Rauchglas. Schiebetür aus Holz (Siberian Ash oder Eucalipto).
Optionales Schubladenelement bis maximal 4/6 Stück aus Holz (Siberian Ash oder Eucalipto) oder matt RAL lackiert.
- Cabinet en two hauteurs en verre extra clair ou fumé. Porte coulissante en bois (Siberian Ash ou Eucalipto).
Option caisson à tiroir, maximum 4/6 pièces, en bois (Siberian Ash ou Eucalipto) ou laqué RAL mat.

	I E D F	dimensioni dimension abmessungen dimension	spessore thickness stärke épaisseur	volume volume volumen volume	carico ammesso admitted load tragfähigkeit charge admise	peso weight gewicht poids	prezzo price preis prix
		cm	mm	m3	kg	kg	euro

Shoji cabinet Wood design Studio Hosoe e Lorenzo De Bartolomeis 2019/2020	C3	100 x 50 x h 160	10/12	1,47	80/*15	231	<input type="checkbox"/> 4.310
							<input checked="" type="checkbox"/> 4.520

C3

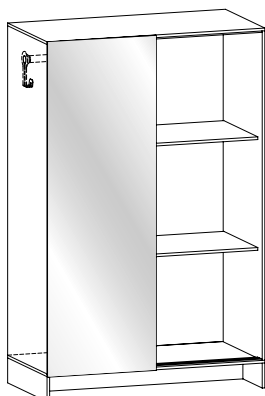

Specificare sempre la finitura dell'anta in legno Siberian Ash o Eucalipto
Always specify finish of wood door Siberian Ash or Eucalipto
Immer Ausführung der Holztür angeben Siberian Ash oder Eucalipto
Indiquer toujours finition de la porte en bois Siberian Ash ou Eucalipto

* ogni ripiano / each shelf / jedes Fach chaque étagère

- struttura vetro extrachiaro / extra clear glass structure / extrahelle Struktur / structure verre extra clair**
 struttura vetro fumè / smoked glass structure / Struktur aus Rauchglas / structure en verre fumé

C

optional cassetiera in legno impiallacciato Siberian Ash o Eucalipto **880**
optional drawer unit in veneer Siberian Ash or Eucalipto
optionales Schubladenelement aus furniertem Holz Siberian Ash oder Eucalipto
option caisson à tiroir en bois plaqué Siberian Ash ou Eucalipto

C



C

optional cassetiera in legno laccato RAL opaco **860**
optional wooden matt RAL lacquered drawer unit
optionales Schubladenelement aus Holz matt RAL lackiert
option caisson à tiroir en bois laqué RAL mat

Specificare sempre la finitura della cassetiera / always specify finish of drawer unit
immer Ausführung des Schubladenelement angeben / toujours spécifier finition caisson à tiroir

- Cabinet con asta appendiabiti in vetro extrachiaro o fumè. Anta scorrevole in legno (Siberian Ash o Eucalipto).
Optional fino ad un massimo di 3 cassettiere in legno (Siberian Ash o Eucalipto) o laccato RAL opaco.
- Cabinet available in extra clear or smoked glass with coat hanger rod. Sliding door in wood (Siberian Ash or Eucalipto).
Optional drawer unit, up to maximum 3, in wood (Siberian Ash or Eucalipto) or matt RAL lacquered.
- Schrank aus extrahellem Glas oder Rauchglas mit Kleiderstab. Schiebetür aus Holz (Siberian Ash oder Eucalipto).
Optionales Schubladenelement bis maximal 3 Stück aus Holz (Siberian Ash oder Eucalipto) oder matt RAL lackiert.
- Cabinet en verre extra clair ou fumé avec bâton porte-manteau. Porte coulissante en bois (Siberian Ash ou Eucalipto).
Option caisson à tiroir, maximum 3 pièces, en bois (Siberian Ash ou Eucalipto) ou laqué RAL mat.

	I E D F	dimensioni dimension abmessungen dimension	spessore thickness stärke épaisseur	volume volume volumen volume	carico ammesso admitted load tragfähigkeit charge admise	peso weight gewicht poids	prezzo price preis prix
		cm	mm	m3	kg	kg	euro

Shoji madia

design Studio Hosoe e
Lorenzo De Bartolomeis 2018

A1 - 150 x 50 x h.62	10 / 12	0,84	80	140	■ 2.460
A2 - 150 x 50 x h.62	10 / 12	0,84	80	149	■ 2.470
A3 - 150 x 50 x h.72	10 / 12	0,94	80	158	■ 2.590

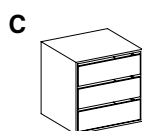
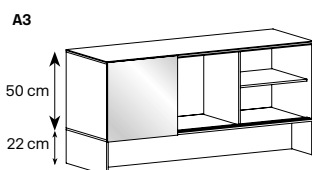
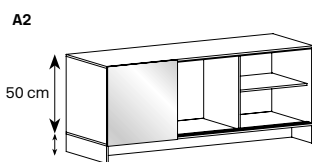
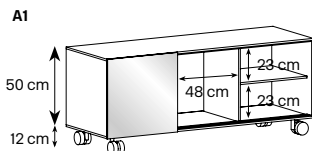

- Maggiorazione per finitura **top** in ceramica / supplement for ceramic **top** / Aufpreis für **Top** aus Keramik / supplément pour **top** en céramique. **500**
- Maggiorazione per finitura **anta** in ceramica / supplement for **door** in ceramic / Aufpreis für **Tür** aus Keramik / supplément pour **porte** en céramique. **85**
- Maggiorazione per finitura **schienale** in ceramica / supplement for **back panel** in ceramic / Aufpreis für **Rückwand** aus Keramik / supplément pour **dos** en céramique. **490**
- C** Optional cassetiera in legno impiallacciato noce canaletto / optional chest of drawers in veneer wood walnut canaletto / Optional Schubladenelement aus Furnierholz Canaletto Walnuß option caisson à tiroir en bois plaqué noyer canaletto. **870**
- C** optional cassetiera in legno impiallacciato Siberian Ash o Eucalipto optional drawer unit in veneer Siberian Ash or Eucalipto optionales Schubladenelement aus furniertem Holz Siberian Ash oder Eucalipto option caisson à tiroir en bois plaqué Siberian Ash ou Eucalipto **880**
- C** Optional cassetiera RAL opaco / optional chest of drawers matt RAL optionales Schubladenelement matt RAL/ option caisson à tiroir RAL mat. **860**

■ struttura vetro fumè, **anta a specchio fumé o bronzo** / structure in smoked glass, **door in smoked or bronze mirror** / Struktur aus Rauchglas, **Tür aus Rauchspiegel oder Bronzespiegel** / structure verre fumé, **porte en miroir fumé ou bronze.**

- **Specificare sempre la finitura dell'anta a specchio / always specify door finish / immer Ausführung der Tür angeben / spécifier toujours finition porte.**

- Madia su ruote o base fissa in 2 altezze a 3 o 4 moduli in vetro fumè, anta/e scorrevole a specchio. Top, anta/e e schienale disponibile in ceramica: **Pietra di Savoia antracite bocciardato, Noir desir lucido o opaco, Emperador lucido o opaco, Calacatta oro venato lucido, Pietra Grey lucido o opaco, Sahara noir lucido o bocciardato.** Optional cassetiera in noce canaletto, Siberian Ash, Eucalipto o RAL opaco.
- Sideboard with castors or fix base in 2 heights with 3 or 4 modules in smoked glass, sliding door/s in mirror. Top, door/s and back available in ceramic: **Pietra di Savoia anthracite bocciardato, Noir desir polished or matt, Emperador polished or matt, Calacatta oro venato polished, Pietra Grey polished or matt, Sahara noir polished or bocciardato.** Optional chest of drawers in walnut, Siberian Ash, Eucalipto or matt RAL.
- Sideboard mit Rädern oder fix in 2 Höhen mit 3 oder 4 Modulen aus Rauchglas, Schiebetür/en aus Spiegel. Top, Tür/e und Rückwand in Keramik verfügbar: **Pietra di Savoia Anthrazit bocciardato, Noir desir glänzend oder matt, Emperador glänzend oder matt, Calacatta oro venato glänzend, Pietra Grey glänzend oder matt, Sahara noir glänzend oder bocciardato.** Optionales Schubladenelement aus Walnuss Canaletto, Siberian Ash, Eucalipto oder matt RAL.
- Buffet avec roulettes ou fix en 2 hauteurs avec 3 ou 4 modules en verre fumé, porte/s coulissant/s en miroir. Top, porte/s et dos disponible en céramique: **Pietra di Savoia anthracite mat, Noir desir brillant ou mat, Emperador brillant ou mat, Calacatta oro venato brillant, Pietra Grey brillant ou mat, Sahar noir brillant ou bocciardato.** Option caisson à tiroir en noyer canaletto, Siberian Ash, Eucalipto ou matt RAL.

	I E D F	dimensioni dimension abmessungen dimension	spessore thickness stärke épaisseur	volume volume volumen volume	carico ammesso admitted load tragfähigkeit charge admise	peso weight gewicht poids	prezzo price preis prix
		cm	mm	m3	kg	kg	euro

Shoji madia

design Studio Hosoe e
Lorenzo De Bartolomeis 2018

B1 - 200 x 50 x h.62	10 / 12	1,07	80	172	■ 3.170
B2 - 200 x 50 x h.62	10 / 12	1,07	80	182	■ 3.190
B3 - 200 x 50 x h.72	10 / 12	1,21	80	192	■ 3.340

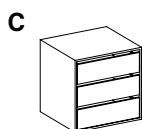
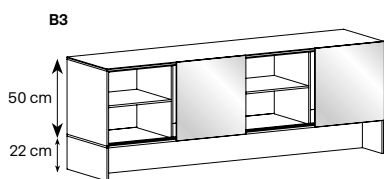
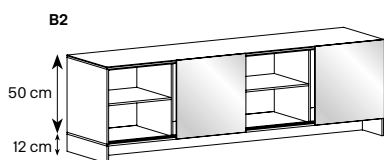
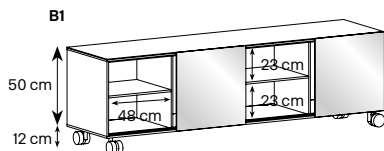

- Maggiorazione per finitura **top** in ceramica / supplement for ceramic **top** / Aufpreis für **Top** aus Keramik / supplément pour **top** en céramique. **670**

- Maggiorazione per finitura **anta** in ceramica / supplement for **door** in ceramic / Aufpreis für **Tür** aus Keramik / supplément pour **porte** en céramique. **170**

- Maggiorazione per finitura **schienale** in ceramica / supplement for **back panel** in ceramic / Aufpreis für **Rückwand** aus Keramik / supplément pour **dos** en céramique. **660**

C Optional cassetiera in legno impiallacciato noce canaletto / optional chest of drawers in veneer wood walnut canaletto / Optional Schubladenelement aus Furnierholz Canaletto Walnuß option caisson à tiroir en bois plaqué noyer canaletto. **870**

C optional cassetiera in legno impiallacciato Siberian Ash o Eucapilto optional drawer unit in veneer Siberian Ash or Eucalipto optionales Schubladenelement aus furniertem Holz Siberian Ash oder Eucalipto option caisson à tiroir en bois plaqué Siberian Ash ou Eucalipto **880**

C Optional cassetiera RAL opaco / optional chest of drawers matt RAL optionales Schubladenelement matt RAL/ option caisson à tiroir RAL mat. **860**

■ struttura vetro fumè, **anta a specchio fumé o bronzo** / structure in smoked glass, **door in smoked or bronze mirror** / Struktur aus Rauchglas, **Tür aus Rauchspiegel oder Bronzespiegel** / structure verre fumé, **porte en miroir fumé ou bronze**.

- **Specificare sempre la finitura dell'anta a specchio / always specify door finish / immer Ausführung der Tür angeben / spécifier toujours finition porte.**

- Madia su ruote o base fissa in 2 altezze a 3 o 4 moduli in vetro fumè, anta/e scorrevole a specchio. Top, anta/e e schienale disponibile in ceramica: **Pietra di Savoia antracite bocciardato, Noir desir lucido o opaco, Emperador lucido o opaco, Calacatta oro venato lucido, Pietra Grey lucido o opaco, Sahara noir lucido o bocciardato.**

Optional cassetiera in noce canaletto, Siberian Ash, Eucalipto o RAL opaco.

- Sideboard with castors or fix base in 2 heights with 3 or 4 modules in smoked glass, sliding door/s in mirror. Top, door/s and back available in ceramic: **Pietra di Savoia antracite bocciardato, Noir desir polished or matt, Emperador polished or matt, Calacatta oro venato polished, Pietra Grey polished or matt, Sahara noir polished or bocciardato.**

Optional chest of drawers in walnut, Siberian Ash, Eucalipto or matt RAL.

- Sideboard mit Rädern oder fix in 2 Höhen mit 3 oder 4 Modulen aus Rauchglas, Schiebetür/en aus Spiegel.

Top, Tür/e und Rückwand in Keramik verfügbar: **Pietra di Savoia Anthrazit bocciardato, Noir desir glänzend oder matt, Emperador glänzend oder matt, Calacatta oro venato glänzend, Pietra Grey glänzend oder matt, Sahara noir glänzend oder bocciardato.**

Optionales Schubladenelement aus Walnuss Canaletto, Siberian Ash, Eucalipto oder matt RAL.

- Buffet avec roulettes ou fix en 2 hauteurs avec 3 ou 4 modules en verre fumé, porte/s coulissant/s en miroir.

Top, porte/s et dos disponible en céramique : **Pietra di Savoia anthracite mat, Noir desir brillant ou mat, Emperador brillant ou mat, Calacatta oro venato brillant, Pietra Grey brillant ou mat, Sahar noir brillant ou bocciardato.**

Option caisson à tiroir en noyer canaletto, , Siberian Ash, Eucalipto ou matt RAL.

Soft glass

design Massimo Castagna 2023

SG001

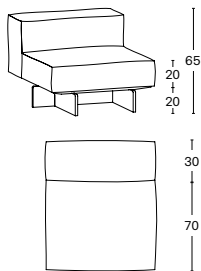

85 x 100 x h 65

dimensioni / dimension / abmessungen / dimension			
85 x 100 x h 65			
TESSUTO C FABRIC C STOFF C TISSU C	TESSUTO P FABRIC P STOFF P TISSU P	TESSUTO F FABRIC F STOFF F TISSU F	TESSUTO B FABRIC B STOFF B TISSU B
2.940	2.970	3.200	3.290

SG010

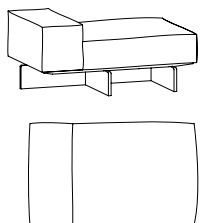

SG011

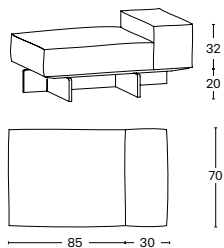

115 x 70 x h 52

dimensioni / dimension / abmessungen / dimension			
115 x 70 x h 52			
TESSUTO C FABRIC C STOFF C TISSU C	TESSUTO P FABRIC P STOFF P TISSU P	TESSUTO F FABRIC F STOFF F TISSU F	TESSUTO B FABRIC B STOFF B TISSU B
2.700	2.730	2.920	3.010

SG020

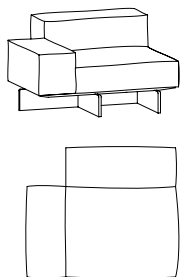

SG021

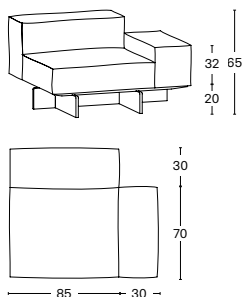

115 x 100 x h 65

dimensioni / dimension / abmessungen / dimension			
115 x 100 x h 65			
TESSUTO C FABRIC C STOFF C TISSU C	TESSUTO P FABRIC P STOFF P TISSU P	TESSUTO F FABRIC F STOFF F TISSU F	TESSUTO B FABRIC B STOFF B TISSU B
3.820	3.860	4.170	4.310

SG030

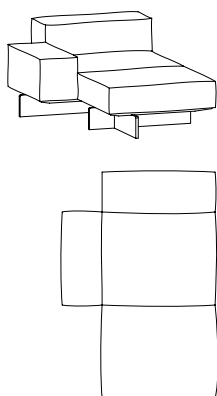

SG031

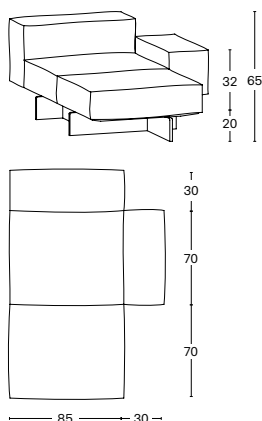

115 x 170 x h 65

dimensioni / dimension / abmessungen / dimension			
115 x 170 x h 65			
TESSUTO C FABRIC C STOFF C TISSU C	TESSUTO P FABRIC P STOFF P TISSU P	TESSUTO F FABRIC F STOFF F TISSU F	TESSUTO B FABRIC B STOFF B TISSU B
5.450	5.510	5.930	6.110

SG040

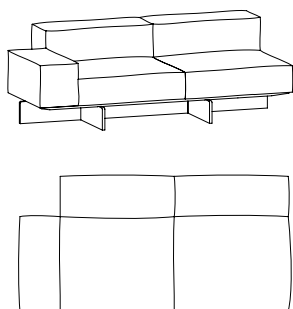

SG041

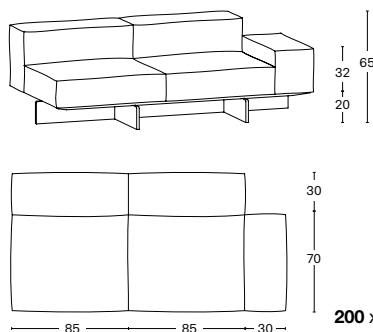

200 x 100 x h 65

dimensioni / dimension / abmessungen / dimension			
200 x 100 x h 65			
TESSUTO C FABRIC C STOFF C TISSU C	TESSUTO P FABRIC P STOFF P TISSU P	TESSUTO F FABRIC F STOFF F TISSU F	TESSUTO B FABRIC B STOFF B TISSU B
6.110	6.180	6.720	6.950

Soft glass

design Massimo Castagna 2023

SG050

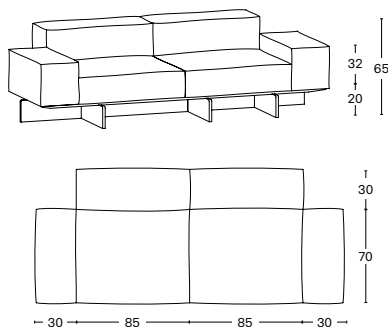

230 x 100 x h 65

dimensioni / dimension / abmessungen / dimension			
230 x 100 x h 65			
TESSUTO C	TESSUTO P	TESSUTO F	TESSUTO B
FABRIC C	FABRIC P	FABRIC F	FABRIC B
STOFF C	STOFF P	STOFF F	STOFF B
TISSU C	TISSU P	TISSU F	TISSU B
6.970	7.050	7.670	7.940

SG060

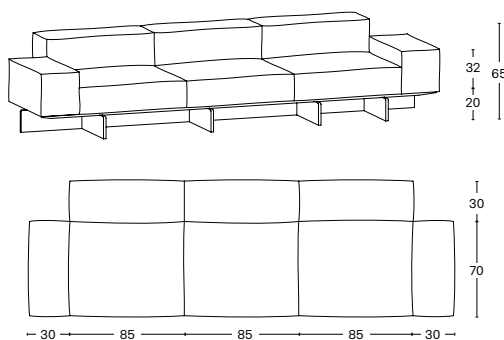

315 x 100 x h 65

dimensioni / dimension / abmessungen / dimension			
315 x 100 x h 65			
TESSUTO C	TESSUTO P	TESSUTO F	TESSUTO B
FABRIC C	FABRIC P	FABRIC F	FABRIC B
STOFF C	STOFF P	STOFF F	STOFF B
TISSU C	TISSU P	TISSU F	TISSU B
9.340	9.450	10.280	10.660

SG070

SG071

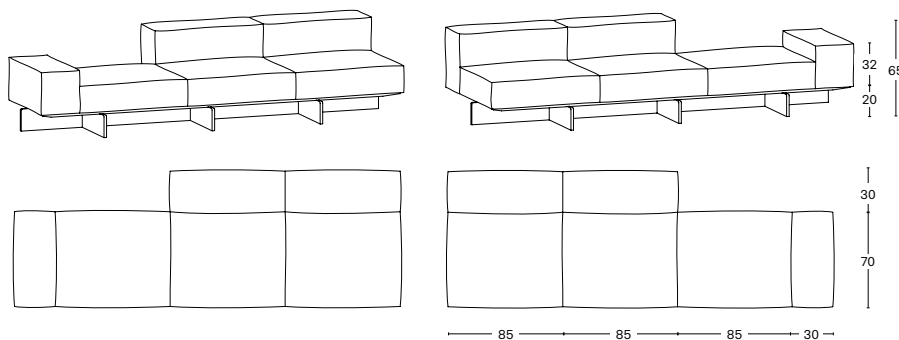

285 x 100 x h 65

dimensioni / dimension / abmessungen / dimension			
285 x 100 x h 65			
TESSUTO C	TESSUTO P	TESSUTO F	TESSUTO B
FABRIC C	FABRIC P	FABRIC F	FABRIC B
STOFF C	STOFF P	STOFF F	STOFF B
TISSU C	TISSU P	TISSU F	TISSU B
8.060	8.140	8.780	9.070

Specificare sempre la finitura del basamento in vetro **EXTRACHIARO, FUMÈ O BRONZO**
 always specify finish of glass base **EXTRA CLEAR, SMOKED OR BRONZE.**
 immer Ausführung des Gestell angeben **EXTRAHELLES GLAS, RAUCHGLAS ODER BRONZE GLAS**
 spécifier toujours finition du piètement en verre **EXTRA CLAIR, FUME' OU BRONZE.**

- Divano con struttura portante in legno listellare su basi in vetro stratificato e saldato spessore 20mm, extrachiaro, fumè e bronzo. Sedute, schienali e braccioli imbottiti in poliuretano espanso a densità variabile con materassina in fiocco di fibre acriliche e rivestiti con tessuto protettivo. Rivestimento esterno in tessuto sfoderabile con cucitura doppia a vista. Per finiture tessuti vedi catalogo pagine 350-351. con materassina rivestita con falde di fibre acriliche.
- Sofa with supporting structure made of blockboard on stratified and glued glass of 20mm thickness, extra clear, smoked and bronze. Seatings, backrests and armrests upholstered with differentiated density polyurethane foam and with a mat of acrylic fibers with protective fabric. External lining in removable fabric with visible double stitching. For available fabric finishes see catalogue pages 350-351.
- Sofa mit Tragwerk aus Mehrschichtholz auf Gestell in Schichtglas Stärke 20mm, extrahelles Glas, Rauchglas oder Bronze Glas. Sitzfläche, Rückenlehne und Armlehnen mit Polyurethanschaum mit unterschiedlicher Dichte gepoltert und mit Schutzstoff bezogen. Außenverkleidung aus abziehbarem Stoff mit doppelter sichtlicher Naht. Für verfügbare Stoffe siehe Katalog Seiten 350-351.
- Canapé avec structure portante en bois multicouche sur bases en verre stratifié et collé épaisseur 20mm, extra clair, fumé ou bronze. Assises, dos et bras capitonné en mousse de polyuréthane à densité variable revêtu avec un tapis de fibres acryliques et tissu de protection. Revêtement extérieur en tissu amovible avec double couture à vue. Pour les finitions tissu voir catalogues pages 350-351.

Soft glass

design Massimo Castagna 2023

- Esempi di configurazione
- Composition examples
- Kompositionsbeispiele
- Exemples de composition

Composizione Z

SG010+SG041

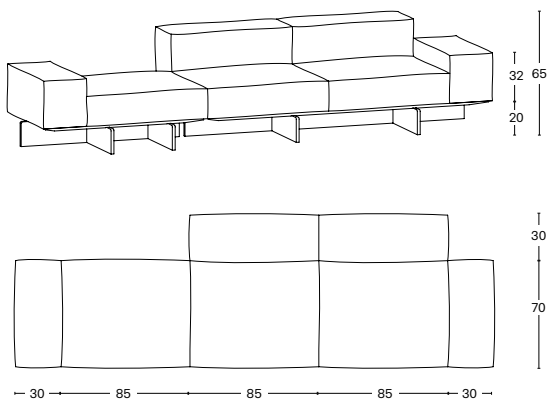

dimensioni / dimension / abmessungen / dimension			
315 x 100 x h 65			
TESSUTO C	TESSUTO P	TESSUTO F	TESSUTO B
FABRIC C	FABRIC P	FABRIC F	FABRIC B
STOFF C	STOFF P	STOFF F	STOFF B
TISSU C	TISSU P	TISSU F	TISSU B
8.810	8.910	9.640	9.960

315 x 100 x h 65

Composizione W

SG040+SG031

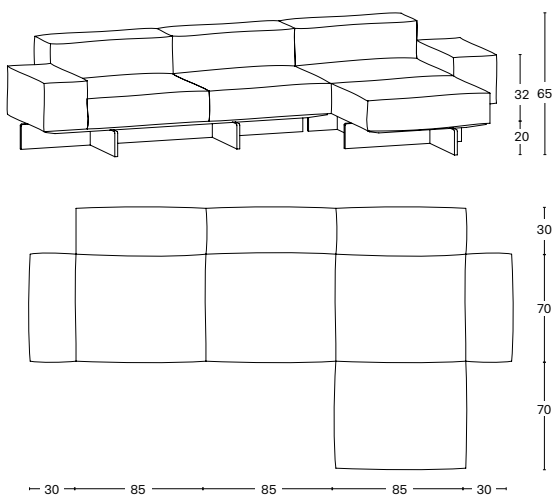

dimensioni / dimension / abmessungen / dimension			
315 x 170 x h 65			
TESSUTO C	TESSUTO P	TESSUTO F	TESSUTO B
FABRIC C	FABRIC P	FABRIC F	FABRIC B
STOFF C	STOFF P	STOFF F	STOFF B
TISSU C	TISSU P	TISSU F	TISSU B
11.560	11.690	12.650	13.060

315 x 170 x h 65

Composizione V

SG040+SG041

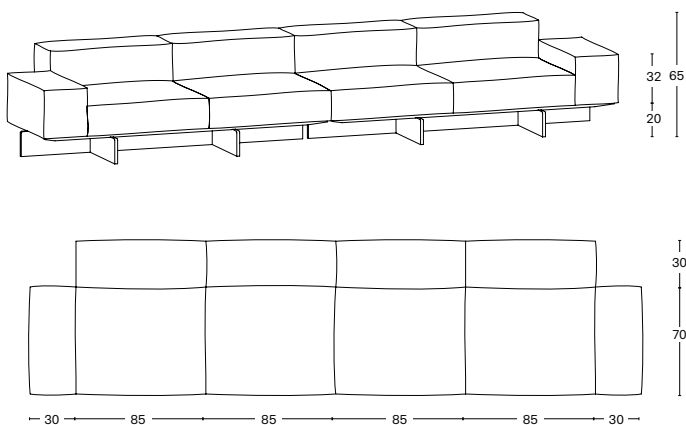

dimensioni / dimension / abmessungen / dimension			
400 x 100 x h 65			
TESSUTO C	TESSUTO P	TESSUTO F	TESSUTO B
FABRIC C	FABRIC P	FABRIC F	FABRIC B
STOFF C	STOFF P	STOFF F	STOFF B
TISSU C	TISSU P	TISSU F	TISSU B
12.220	12.360	13.440	13.900

400 x 100 x h 65

Soft glass

design Massimo Castagna 2023

- Esempi di configurazione
- Composition examples
- Kompositionsbeispiele
- Exemples de composition

Composizione Y

SG040+SG060

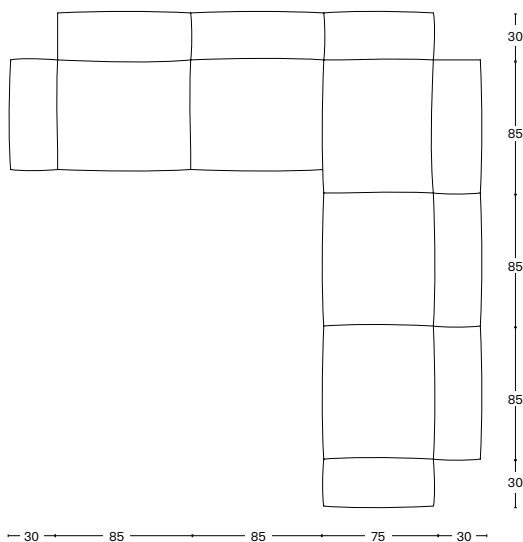
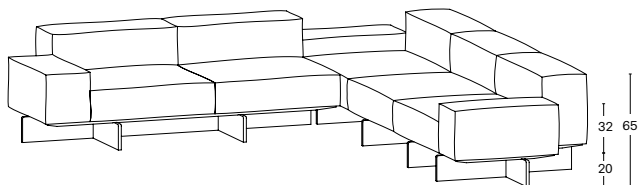

300 x 315 x h 65

dimensioni / dimension / abmessungen / dimension			
300 x 315 x h 65			
TESSUTO C FABRIC C STOFF C TISSU C	TESSUTO P FABRIC P STOFF P TISSU P	TESSUTO F FABRIC F STOFF F TISSU F	TESSUTO B FABRIC B STOFF B TISSU B
15.450	15.630	17.000	17.610

Soft glass cushion

design Massimo Castagna 2023

SGC50



Cuscino 50x50 cm in fibre acriliche anallergiche, rivestito in tessuto, sfoderabile.
Cushion 50x50 cm of hypoallergenic acrylic fibers, covered in fabric, removable cover.
Kissen 50x50 cm aus hypoallergenen Acrylfasern, mit Stoff bezogen, abnehmbar.
Coussin 50x50 cm en flocons de fibres acryliques hypoallergéniques, recouvert de tissu, déhoussable.

dimensioni / dimension / abmessungen / dimension			
50 x 50			
TESSUTO C FABRIC C STOFF C TISSU C	TESSUTO P FABRIC P STOFF P TISSU P	TESSUTO F FABRIC F STOFF F TISSU F	TESSUTO B FABRIC B STOFF B TISSU B
180	185	225	240

SGC70

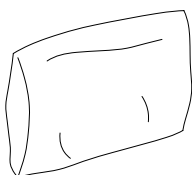

Cuscino 70x35 cm in fibre acriliche anallergiche, rivestito in tessuto, sfoderabile.
Cushion 70x35 cm of hypoallergenic acrylic fibers, covered in fabric, removable cover.
Kissen 70x35 cm aus hypoallergenen Acrylfasern, mit Stoff bezogen, abnehmbar.
Coussin 70x35 cm en flocons de fibres acryliques hypoallergéniques, recouvert de tissu, déhoussable.

dimensioni / dimension / abmessungen / dimension			
70 x 35			
TESSUTO C FABRIC C STOFF C TISSU C	TESSUTO P FABRIC P STOFF P TISSU P	TESSUTO F FABRIC F STOFF F TISSU F	TESSUTO B FABRIC B STOFF B TISSU B
250	255	310	335

	I E D F	dimensioni dimension abmessungen dimension	spessore thickness stärke épaisseur	volume volume volumen volume	carico ammesso admitted load tragfähigkeit charge admise	peso weight gewicht poids	prezzo price preis prix
		cm	mm	m3	kg	kg	euro

Shine

design D'Urbino - Lomazzi 1999

90 x 36 x h 162	12 / 8 / 5	0,89	7,5 *	116	2.940
50 x 36 x h 162	12 / 8 / 5	0,51	5 *	72	2.330

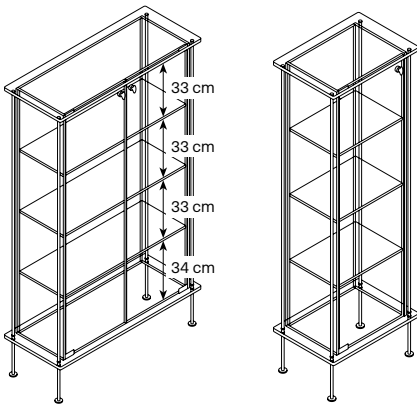

* ogni ripiano / on each shelf / auf jedem Bord / pour chaque étagère

- Vetrine in vetro e supporti in metallo. Disponibili in due misure.
- Glass cabinet with metal supports. Available in two sizes.
- Vitrinen aus Glas und Metallstangen. In zwei Größen verfügbar.
- Vitrines en verre et supports en métal. Disponibles en deux dimensions.

Soglia

design Isao Hosoe 1989

Ø 50 x h 180	12 / 8	0,75		55	1.180
--------------	--------	------	--	----	-------

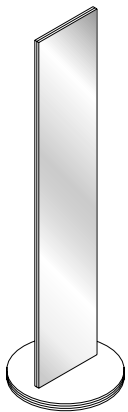

- Specchio bifacciale su base rotante.
- Double sided mirror on revolving base.
- Beidseitiger Spiegel auf drehbarer Basis.
- Miroir sur deux fronts sur base pivotante.

	I E D F	dimensioni dimension abmessungen dimension	spessore thickness stärke épaisseur	volume volume volumen volume	carico ammesso admitted load tragfähigkeit charge admise	peso weight gewicht poids	prezzo price preis prix
		cm	mm	m3	kg	kg	euro

Stati d'animo

design Garattoni - De Angelis 2002

40 x 40	4	0,015		4	●	150
40 x 40	4	0,015		4	●●	160
40 x 40	4	0,015		4	●●●	170

convesso
convex
konvex
convexe

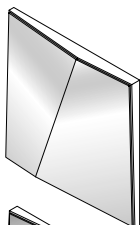

concavo
concave
konkav
concave

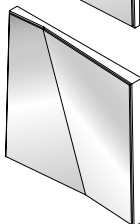

- Barra per fissaggio n° 2 specchi / Bar to fix nr.2 mirrors
- Stange für Montage von 2 Spiegeln / Tige pour le fixage de 2 miroirs

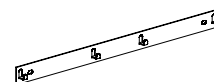

35

- Barra per fissaggio n° 3 specchi / Bar to fix nr.3 mirrors
- Stange für Montage von 3 Spiegeln / Tige pour le fixage de 3 miroirs

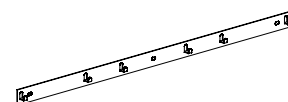

45

- Specchio / Mirror / Spiegel / Miroir
- Specchio fumè / Smoked mirror / Rauchglasspiegel / miroir fumé
- Specchio bronzo / Bronze mirror / Bronze Spiegel / Miroir bronze

- Piccoli specchi quadrati concavi o convessi.
- Small concave or convex square mirrors.
- Kleine viereckige, konkave oder konvexe Spiegel.
- Petits miroirs carrés concaves et convexas.

Strappo

design Luigi Serafini 1989

130 x 72 x h 38	15	0,455	50	61	1.380
-----------------	----	-------	----	----	-------

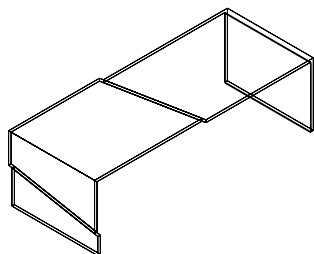

- Tavolino con piano tagliato e saldato a sbalzo.
- Low table with a jointed top.
- Niedriger Tisch mit versetzten und verklebten Platte.
- Petite table avec plateaux coupés et soudés décalés.

	I E D F	dimensioni dimension abmessungen dimension	spessore thickness stärke épaisseur	volume volume volumen volume	carico ammesso admitted load tragfähigkeit charge admise	peso weight gewicht poids		prezzo price preis prix
		cm	mm	m3	kg	kg		euro

T5

design Giulio Mancini 2018

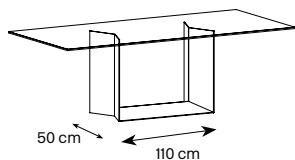

200 x 100 x h.75	12	0,70	150	112	○ 2.360 □ 2.460 ■ 2.580 ○○ 3.140 □ 3.240 ■ 3.360 ○○○ 3.030 □ 3.130 ■ 3.250
------------------	----	------	-----	-----	--

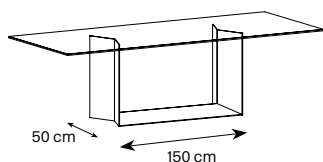

225 x 90 x h.75	12	0,72	150	125	○ 2.470 □ 2.580 ■ 2.700 ○○ 3.290 □ 3.400 ■ 3.520 ○○○ 3.160 □ 3.270 ■ 3.390
-----------------	----	------	-----	-----	--

240 x 100 x h.75	12	0,92	150	130	○ 2.540 □ 2.660 ■ 2.790 ○○ 3.360 □ 3.480 ■ 3.610 ○○○ 3.230 □ 3.350 ■ 3.480
------------------	----	------	-----	-----	--

245 x 120 x h.75	12	0,96	150	157	○ 2.600 □ 2.750 ■ 2.900 ○○ 3.420 □ 3.570 ■ 3.720 ○○○ 3.290 □ 3.440 ■ 3.590
------------------	----	------	-----	-----	--

260 x 100 x h.75	12	0,94	150	154	○ 2.920 □ 3.080 ■ 3.240 ○○ 3.740 □ 3.900 ■ 4.060 ○○○ 3.610 □ 3.770 ■ 3.930
------------------	----	------	-----	-----	--

280 x 100 x h.75	15	0,95	150	171	○ 3.180 □ 3.360 ■ - ○○ 4.000 □ 4.180 ■ - ○○○ 3.870 □ 4.030 ■ -
------------------	----	------	-----	-----	--

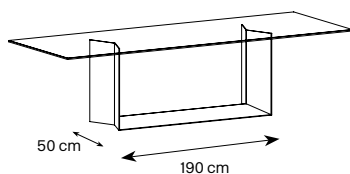

300 x 100 x h.75	15	1,16	150	179	○ 3.440 □ 3.770 ■ - ○○ 4.300 □ 4.630 ■ - ○○○ 4.150 □ 4.480 ■ -
------------------	----	------	-----	-----	--

- Vetro extrachiaro / extra clear glass / extrahelles Glas / verre extra clair
- Vetro fumé / smoked glass / Rauchglas / verre fumé
- basamento **nero grafite o bianco opaco** / base **graphite black or matt white**
Gestell **Grafitsschwarz oder matt weiß** / piètement **noir graphite ou mat blanc**.
- basamento **bronzo o Titanio spazzolato** / base **brushed bronze or Titanio**
Gestell **Bronze oder Titanio gebürstet** / piètement **bronze ou Titanio brossé**
- basamento **champagne metallizzato** / **metallic champagne** base
Gestell **metallisierte Champagnerfarbe** / piètement **champagne métallisé**

**Specificare sempre la finitura del basamento verniciato / always specify finish of laquered base
immer Ausführung des lackierten Gestell angeben / spécifier toujours finition du piètement laqué.**

- Tavolo con basamento centrale nelle finiture: bronzo o Titanio spazzolato, champagne metallizzato, verniciato nero grafite o bianco opaco. Top in appoggio in vetro trasparente, extrachiaro o fumé.
- Dining table with central base in following finishes: brushed bronze or Titanio, metallic champagne, graphite black or matt white lacquered. Top in transparent, extra clear or smoked glass.
- Esstisch mit zentralem Gestell in folgenden Ausführungen: Bronze oder Titanio gebürstet, metallisierte Champagnerfarbe, Grafitsschwarz oder matt weiß lackiert. Top aus transparentem, extrahellem Glas oder Rauchglas.
- Table avec piètement central dans les finitions : bronze ou Titanio brossé, champagne métallisé, laqué noir graphite ou mat blanc. Top en verre transparent, extra clair ou fumé.

	I E D F	dimensioni dimension abmessungen dimension	spessore thickness stärke épaisseur	volume volume volumen volume	carico ammesso admitted load tragfähigkeit charge admise	peso weight gewicht poids	prezzo price preis prix
		cm	mm	m3	kg	kg	euro

T5 fused glass

design Giulio Mancini 2023

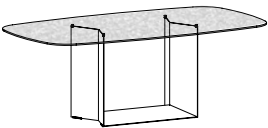
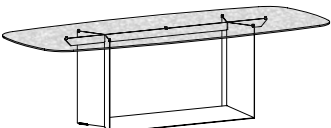
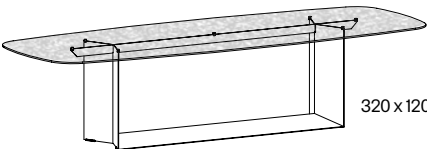
	200 x 110 x h 75	10	0,71	150	110	○ ■ 3.720 ○ ■ 3.700 ○○ ■ 4.500 ○○ ■ 4.480 ○○○ ■ 4.390 ○○○ ■ 4.370
	220 x 110 x h 75	10	0,74	150	121	○ ■ 3.850 ○ ■ 3.830 ○○ ■ 4.630 ○○ ■ 4.590 ○○○ ■ 4.520 ○○○ ■ 4.480
	240 x 110 x h 75	10	0,94	150	129	○ ■ 4.090 ○ ■ 4.070 ○○ ■ 4.870 ○○ ■ 4.850 ○○○ ■ 4.760 ○○○ ■ 4.740
	260 x 110 x h 75	10	0,96	150	152	○ ■ 4.490 ○ ■ 4.470 ○○ ■ 5.310 ○○ ■ 5.340 ○○○ ■ 5.180 ○○○ ■ 5.210
	280 x 110 x h 75	10	0,97	150	167	○ ■ 4.540 ○ ■ 4.520 ○○ ■ 5.360 ○○ ■ 5.340 ○○○ ■ 5.230 ○○○ ■ 5.210
	300 x 110 x h 75	10	1,19	150	175	○ ■ 4.970 ○ ■ 4.950 ○○ ■ 5.830 ○○ ■ 5.810 ○○○ ■ 5.680 ○○○ ■ 5.660
	320 x 120 x h 75	10	1,22	150	205	○ ■ 5.090 ○ ■ 5.070 ○○ ■ 5.950 ○○ ■ 5.930 ○○○ ■ 5.800 ○○○ ■ 5.780

- Vetro fuso fumé / smoked fused glass / geschmolzenes Rauchglas / verre en fusion fumé
- Vetro fuso bronzo / bronze fused glass / geschmolzenes Bronze Glas / verre en fusion bronze
- basamento **nero grafite o bianco opaco** / base **graphite black or matt white**
Gestell **Grafitschwarz oder matt weiß** / piètement **noir graphite ou mat blanc**.
- basamento **bronzo o Titanio spazzolato** / base **brushed bronze or Titanio**
Gestell **Bronze oder Titanio gebürstet** / piètement **bronze ou Titanio brossé**
- basamento **champagne metallizzato** / **metallic champagne** base
Gestell **metallisierte Champagnerfarbe** / piètement **champagne métallisé**

**Specificare sempre la finitura del basamento verniciato / always specify finish of laquered base
immer Ausführung des lackierten Gestell angeben / spécifier toujours finition du piètement laqué.**

- Tavolo con basamento centrale nelle finiture: bronzo o Titanio spazzolato, champagne metallizzato, verniciato nero grafite o bianco opaco. Top in appoggio in vetro fuso fumé o bronzo.
- Dining table with central base in following finishes: brushed bronze or Titanio, metallic champagne, graphite black or matt white lacquered. Top in fused smoked or bronze glass.
- Esstisch mit zentralem Gestell in folgenden Ausführungen: Bronze oder Titanio gebürstet, metallisierte Champagnerfarbe, Grafitschwarz oder matt weiß lackiert. Top aus geschmolzenem Rauchglas oder Bronze Glas.
- Table avec piètement central dans les finitions : bronze ou Titanio brossé, champagne métallisé, laqué noir graphite ou mat blanc. Top en verre en fusion fumé ou bronze.

	I E D F	dimensioni dimension abmessungen dimension	spessore thickness stärke épaisseur	volume volume volumen volume	carico ammesso admitted load tragfähigkeit charge admise	peso weight gewicht poids	prezzo price preis prix
		cm	mm	m3	kg	kg	euro

T5 ceramic

design Giulio Mancini 2018

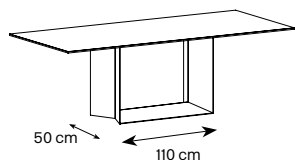

200 x 100 x h.75

8+5

0,70

150

128

○ 3.510

○○ 4.290

○○○ 4.180

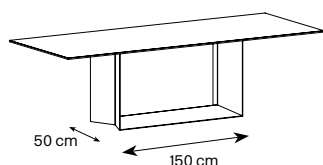

220 x 100 x h.75

8+5

0,71

150

136

○ 3.760

○○ 4.580

○○○ 4.470

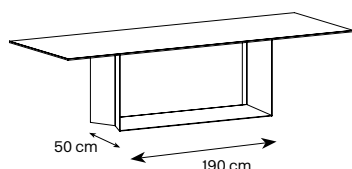

240 x 100 x h.75

8+5

0,85

150

152

○ 4.160

○○ 4.980

○○○ 4.850

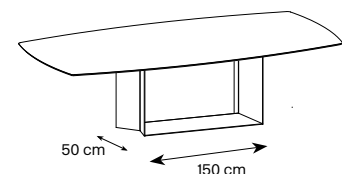

260 x 100 x h.75

8+5

0,94

150

163

○ 4.260

○○ 5.080

○○○ 4.950

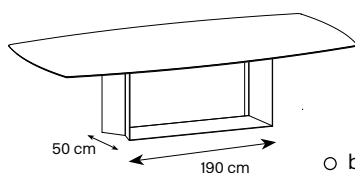

300 x 100 x h.75

10+5

1,16

150

192

○ 4.920

○○ 5.780

○○○ 5.630

320 x 120 x h.75

10+5

1,25

150

242

○ 6.400

○○ 7.260

○○○ 7.110

240 x 115 x h.75

8+5

0,95

150

170

○ 4.390

○○ 5.210

○○○ 5.080

280 x 115 x h.75

8+5

0,38

150

188

○ 4.980

○○ 5.800

○○○ 5.670

320 x 115 x h.75

10+5

1,20

150

218

○ 5.480

○○ 6.340

○○○ 6.190

- basamento **nero grafite o bianco opaco** / base **graphite black or matt white**
Gestell **Grafit schwarz oder matt weiß** / piètement **noir graphite ou mat blanc.**
- basamento **bronzo o Titanio spazzolato** / base **brushed bronze or Titanio**
Gestell **Bronze oder Titanio gebürstet** / piètement **bronze ou Titanio brossé**
- basamento **champagne metallizzato** / **metallic champagne** base
Gestell **metallisierte Champagnerfarbe** / piètement **champagne métallisé**

- **Specificare sempre la finitura del basamento verniciato / always specify finish of laquered base.**
immer Ausführung des lackierten Gestell angeben / spécifier toujours finition du piètement laqué.
- **Specificare sempre la finitura del top ceramica / always specify finish of ceramic top.**
immer Keramikausführung der Platte angeben / spécifier toujours finition top en céramique.

- Tavolo con basamento centrale nelle seguenti finiture: bronzo o Titanio spazzolato, champagne metallizzato, verniciato nero grafite o bianco opaco.
Top in appoggio in ceramica nelle finiture: **Pietra di Savoia antracite bocciardato, Noir desir lucido o opaco, Emperador lucido o opaco, Calacatta oro venato lucido, Pietra Grey lucido o opaco, Sahara noir lucido o bocciardato.**
- Dining table with central base in following finishes: brushed bronze or Titanio, metallic champagne, graphite black or matt white lacquered.
Ceramic top in following finishes: **Pietra di Savoia anthracite bocciardato, Noir desir polished or matt, Emperador polished or matt, Calacatta oro venato polished, Pietra Grey polished or matt, Sahara noir polished or bocciardato.**
- Esstisch mit zentralem Gestell in folgenden Ausführungen: Bronze oder Titanio gebürstet, metallisierte Champagnerfarbe, Grafit schwarz oder matt weiß lackiert. Keramiktop in folgenden Ausführungen: **Pietra di Savoia Anthrazit bocciardato, Noir desir glänzend oder matt, Emperador glänzend oder matt, Calacatta oro venato glänzend, Pietra Grey glänzend oder matt, Sahara noir glänzend oder bocciardato.**
- Table avec piètement central dans les finitions : bronze ou Titanio brossé, champagne métallisé, laqué noir graphite ou mat blanc.
Top en céramique disponible en : **Pietra di Savoia anthracite mat, Noir desir brillant ou mat, Emperador brillant ou mat, Calacatta oro venato brillant, Pietra Grey brillant ou mat, Sahar noir brillant ou bocciardato.**

	I E D F	dimensioni dimension abmessungen dimension	spessore thickness stärke épaisseur	volume volume volumen volume	carico ammesso admitted load tragfähigkeit charge admise	peso weight gewicht poids	prezzo price preis prix
		cm	mm	m3	kg	kg	euro

T5 E

design Giulio Mancini 2019

160/250 x 100 x h.75	10	0,93	*150/**40	172	○ 3.260 ○○ 4.030
180/270 x 100 x h.75	10	1,01	*150/**40	194	○ 3.430 ○○ 4.210

- nero grafite / graphite black / Grafitschwarz / noir graphite
- bronzo spazzolato / brushed bronze / gebürstete Bronze / bronze brossé

- * per piano centrale / central top / zentrale Platte / plateau central
- ** ogni allungo / each extension / jede Verlängerung / chaque allonge

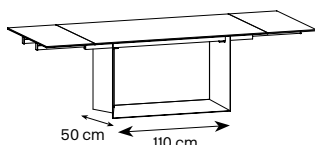

- Tavolo allungabile con basamento centrale nelle finiture: bronzo spazzolato o verniciato nero grafite. **Top e due allunghe in vetro fumè scuro.** Il meccanismo allungabile è sempre verniciato nero opaco.
- Extending table with central base in: brushed bronze or graphite black lacquered. **Top and extensions in dark smoked glass.** Extension mechanism always matt black lacquered.
- Ausziehbarer Tisch mit zentralem Gestell in Ausführung: gebürstete Bronze oder Grafitschwarz lackiert. **Top und ausziehbare Platten aus dunklem Rauchglas.** Ausziehmechanismus immer matt schwarz lackiert.
- Table extensible avec piètement central en bronze brossé ou laqué noir graphite. **Top et allonges en verre fumé foncé.** Mécanisme d'allonge toujours laqué noir mat.

T5 E ceramic

design Giulio Mancini 2019

160/250 x 100 x h.75	6+5	0,93	*150/**40	172	○ 3.990 ○○ 4.770
180/270 x 100 x h.75	6+5	1,01	*150/**40	194	○ 4.400 ○○ 5.180

- nero grafite / graphite black / Grafitschwarz / noir graphite
- bronzo spazzolato / brushed bronze / gebürstete Bronze / bronze brossé

- * per piano centrale / central top / zentrale Platte / plateau central
- ** ogni allungo / each extension / jede Verlängerung / chaque allonge

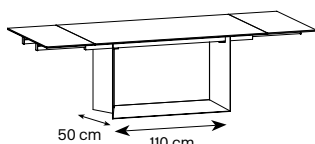

**Specificare sempre la finitura del top ceramica / always specify ceramic top finish
immer Ausführung der Keramikplatte angeben / toujours spécifier finition top céramique**

- Tavolo allungabile con basamento centrale nelle finiture: bronzo spazzolato o verniciato nero grafite. Top e due allunghe in ceramica a vena continua nelle finiture: **Pietra di Savoia antracite bocciardato, Noir desir lucido o opaco, Emperador lucido o opaco, Calacatta oro venato lucido, Pietra Grey lucido o opaco, Sahara noir lucido o bocciardato.** Il meccanismo allungabile è sempre verniciato nero opaco.
- Extending table with central base in: brushed bronze or graphite black lacquered. Top and extensions in ceramic with uninterrupted grain in following finishes: **Pietra di Savoia anthracite bocciardato, Noir desir polished or matt, Emperador polished or matt, Calacatta oro venato polished, Pietra Grey polished or matt, Sahara noir polished or bocciardato.** Extension mechanism always matt black lacquered.
- Ausziehbarer Tisch mit zentralem Gestell in: gebürstete Bronze oder Grafitschwarz lackiert. Top und Verlängerungen aus Kermik mit ununterbrochener Maserung: **Pietra di Savoia Anthrazit bocciardato, Noir desir glänzend oder matt, Emperador glänzend oder matt, Calacatta oro venato glänzend, Pietra Grey glänzend oder matt, Sahara noir glänzend oder bocciardato.** Ausziehmechanismus immer matt schwarz lackiert.
- Table extensible avec piètement central en: bronze brossé ou noir graphite mat. Top et allonges en céramique avec veine continue dans les finitions: **Pietra di Savoia anthracite mat, Noir desir brillant ou mat, Emperador brillant ou mat, Calacatta oro venato brillant, Pietra Grey brillant ou mat, Sahar noir brillant ou bocciardato.** Mécanisme d'allonge toujours laqué noir mat.

	I E D F	dimensioni dimension abmessungen dimension	spessore thickness stärke épaisseur	volume volume volumen volume	carico ammesso admitted load tragfähigkeit charge admise	peso weight gewicht poids	prezzo price preis prix
		cm	mm	m3	kg	kg	euro

T-AB design Giulio Mancini 2019	160/250 x 100 x h.75	10	0,93	*150/**40	172	○ 3.020 ○○ 3.610
	180/270 x 100 x h.75	10	1,01	*150/**40	194	○ 3.200 ○○ 3.790

- nero grafite / graphite black / Grafitsschwarz / noir graphite
 ○○ bronzo spazzolato / brushed bronze / gebürstete Bronze / bronze brossé

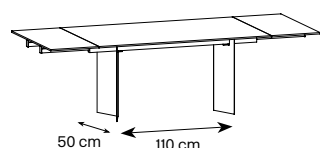

- * per piano centrale / central top / zentrale Platte / plateau central
 ** ogni allungo / each extension / jede Verlängerung / chaque allonge

- Tavolo allungabile con gambe in metallo nelle finiture: bronzo spazzolato o verniciato nero grafite. **Top e due allunghe in vetro fumè scuro.** Il meccanismo allungabile è sempre verniciato nero opaco.
 - Extending table with legs in metal: brushed bronze or graphite black lacquered. **Top and extensions in dark smoked glass.** Extension mechanism always matt black lacquered.
 - Ausziehbarer Tisch mit Metallbeinen: gebürstete Bronze oder Grafitsschwarz lackiert. **Top und Verlängerungen in dunklem Rauchglas.** Ausziehmechanismus immer matt schwarz lackiert.
 - Table extensible avec pieds en métal: bronze brossé ou laqué noir graphite. **Top et allonges en verre fumé foncé.** Mécanisme d'allonge toujours laqué noir mat.

T-AB ceramic design Giulio Mancini 2019	160/250 x 100 x h.75	6+5	0,93	*150/**40	172	○ 3.760 ○○ 4.350
	180/270 x 100 x h.75	6+5	1,01	*150/**40	194	○ 4.170 ○○ 4.760

- nero grafite / graphite black / Grafitsschwarz / noir graphite
 ○○ bronzo spazzolato / brushed bronze / gebürstete Bronze / bronze brossé

- * per piano centrale / central top / zentrale Platte / plateau central
 ** ogni allungo / each extension / jede Verlängerung / chaque allonge

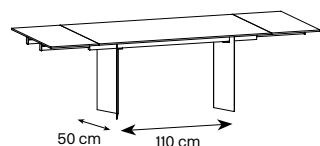

**Specificare sempre la finitura del top ceramica / always specify ceramic top finish
 immer Ausführung der Keramikplatte angeben / toujours spécifier finition top céramique**

- Tavolo allungabile con gambe in metallo nelle finiture: bronzo spazzolato o verniciato nero grafite. **Top e due allunghe in ceramica a vena continua nelle finiture: Pietra di Savoia antracite bocciardato, Noir desir lucido o opaco, Emperador lucido o opaco, Calacatta oro venato lucido, Pietra Grey lucido o opaco, Sahara noir lucido o bocciardato.** Il meccanismo allungabile è sempre verniciato nero opaco.
 - Extending table with metal legs: brushed bronze or graphite black lacquered. **Top and extensions in ceramic with uninterrupted grain in following finishes: Pietra di Savoia anthracite bocciardato, Noir desir polished or matt, Emperador polished or matt, Calacatta oro venato polished, Pietra Grey polished or matt, Sahara noir polished or bocciardato.** Extension mechanism always matt black lacquered.
 - Ausziehbarer Tisch mit Metallbeinen: gebürstete Bronze oder Grafitsschwarz lackiert. **Top und Verlängerungen aus Keramik mit ununterbrochener Maserung: Pietra di Savoia Anthrazit bocciardato, Noir desir glänzend oder matt, Emperador glänzend oder matt, Calacatta oro venato glänzend, Pietra Grey glänzend oder matt, Sahara noir glänzend oder bocciardato.** Ausziehmechanismus immer matt schwarz lackiert.
 - Table extensible avec pieds en métal: bronze brossé ou laqué noir graphite. **Top et allonges en céramique avec veine continue dans les suivantes finitions: Pietra di Savoia anthracite mat, Noir desir brillant ou mat, Emperador brillant ou mat, Calacatta oro venato brillant, Pietra Grey brillant ou mat, Sahar noir brillant ou bocciardato.** Mécanisme d'allonge toujours laqué noir mat.

	I E D F	dimensioni dimension abmessungen dimension	spessore thickness stärke épaisseur	volume volume volumen volume	carico ammesso admitted load tragfähigkeit charge admise	peso weight gewicht poids	prezzo price preis prix
		cm	mm	m3	kg	kg	euro

Tavolante aged oak

design Marco Gaudenzi 2009/2016

200 x 100 x h 75	15/50	0,6	160	110	3.700	□ 3.930
------------------	-------	-----	-----	-----	-------	---------

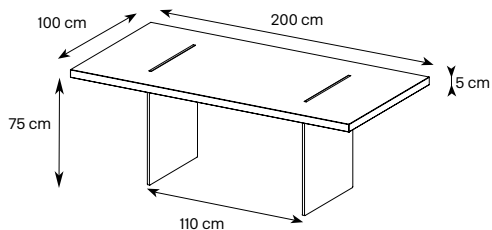

220 x 100 x h 75	15/50	0,66	160	116	3.810	□ 4.040
240 x 100 x h 75	15/50	0,72	160	122	3.920	□ 4.150

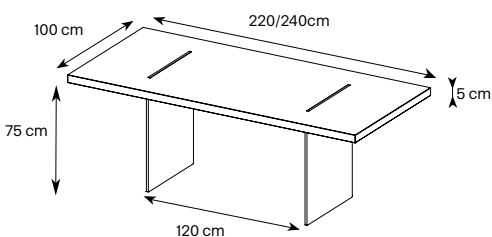

260 x 100 x h 75	15/50	0,78	160	128	4.180	□ 4.410
------------------	-------	------	-----	-----	-------	---------

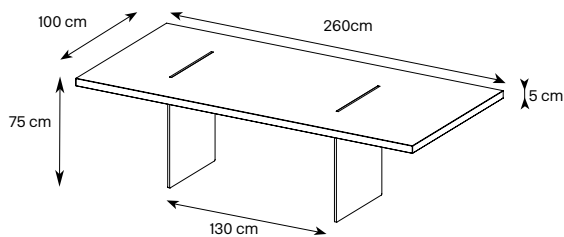

240 x 120 x h 75	15/50	0,86	160	146	4.340	□ 4.570
------------------	-------	------	-----	-----	-------	---------

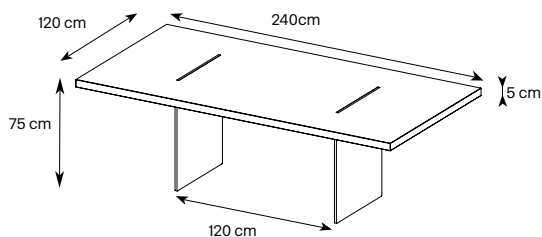

□ basi in vetro extrachiaro/bases in extra clear glass/Beine aus extrahellem Glas/supports en verre extra clair

- Tavolo con base in vetro trasparente o extrachiaro. Top impiallacciato in rovere invecchiato con spessore 50 mm.
- Dining table with transparent or extra clear glass base. Aged oak veneer top 50mm thick.
- Hoher Tisch mit transparentem oder extrahellem glass Gestell. Furnierte Tischplatte aus gealterter Eiche 50mm dick.
- Table haut avec base en verre transparent ou extra clair. Top plaqué chêne vieilli 50mm.

	I E D F	dimensioni dimension abmessungen dimension	spessore thickness stärke épaisseur	volume volume volumen volume	carico ammesso admitted load tragfähigkeit charge admise	peso weight gewicht poids	prezzo price preis prix
		cm	mm	m3	kg	kg	euro

Thrim

design Massimo Castagna 2022

Ø 140 x h 75	10/10	0,62	150	135	□ 3.290 ■ 3.560 ▒ 3.580
Ø 160 x h 75	10/10	0,7	150	169	□ 3.670 ■ 3.970 ▒ 3.990
Ø 180 x h 75	10/10	0,82	150	194	□ 4.170 ■ 4.540 ▒ 4.580
Ø 200 x h 75	10/10	0,94	150	213	□ 4.690 ■ 5.150 ▒ 5.190

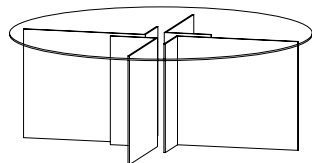

- basamento e piano extrachiaro / extra clear base and top
Gestell und Tischplatte extrahell / piètement et top extra clair
- basamento e piano fumè / smoked base and top
Gestell und Tischplatte aus Rauchglas / piètement et top fumé
- basamento e piano bronzo / bronze base and top
Gestell und Tischplatte aus Bronze Glas / piètement et top bronze

- Tavolo con piano in appoggio in vetro extra chiaro , fumè o bronzo temperato.
Basamento composto da elementi accostabili in vetro extra chiaro , fumè o bronzo.
- Dining table with top in tempered extra clear, smoked or bronze glass.
Base made of combining elements in extra clear, smoked or bronze glass.
- Esstisch mit Top aus Sicherheitsglas extrahell, Rauchglas oder Bronze Glas.
Gestell aus kombinierbaren Elementen aus extrahellem Glas, Rauchglas oder Bronze Glas.
- Table haut avec top en verre trempé en extra clair, fumé ou bronze.
Piètement composé de éléments approchables en verre extra clair, fumé ou bronze.

Thrim fused glass

design Massimo Castagna 2023

Ø 140 x h 75	10/10	0,62	150	135	■ 4.350 ▒ 4.370
Ø 160 x h 75	10/10	0,7	150	169	■ 4.880 ▒ 4.900
Ø 180 x h 75	10/10	0,82	150	194	■ 5.770 ▒ 5.810
Ø 200 x h 75	10/10	0,94	150	213	■ 6.560 ▒ 6.600

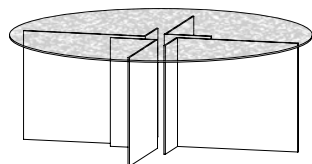

- basamento vetro fumè e piana vetro fuso fumè / base smoked glass and top fused smoked glass
Gestell Rauchglas und Top geschmolzenes Rauchglas / piètement verre fumé et top en verre en fusion fumé
- basamento vetro bronzo e piana vetro fuso bronzo / base bronze glass and top fused bronze glass
Gestell Bronze Glas und Top geschmolzenes Bronze Glas / piètement verre bronze et top verre en fusion bronze

- Tavolo con piano in appoggio in vetro fuso fumè o bronzo.
Basamento composto da elementi accostabili in vetro fumè o bronzo.
- Dining table with propped up top in fused smoked or bronze glass.
Base made of combining elements in smoked or bronze glass.
- Esstisch mit Auflage Top aus geschmolzenem Rauchglas oder Bronze Glas.
Gestell aus kombinierbaren Elementen aus Rauchglas oder Bronze Glas.
- Table haut avec top en appui en verre en fusion fumé ou bronze.
Piètement composé de éléments approchables en verre fumé ou bronze.

	I E D F	dimensioni dimension abmessungen dimension	spessore thickness stärke épaisseur	volume volume volumen volume	carico ammesso admitted load tragfähigkeit charge admise	peso weight gewicht poids	prezzo price preis prix
		cm	mm	m3	kg	kg	euro

Thrim

design Massimo Castagna 2022

140 x 140 x h 75	10/10	0,87	150	186	□ 3.470 ■ 3.750 ▒ 3.770
160 x 160 x h 75	10/10	1,05	150	222	□ 3.860 ■ 4.190 ▒ 4.220
180 x 180 x h 75	10/10	1,22	150	259	□ 4.390 ■ 4.780 ▒ 4.820
200 x 200 x h 75	10/10	1,4	150	291	□ 4.940 ■ 5.420 ▒ 5.460

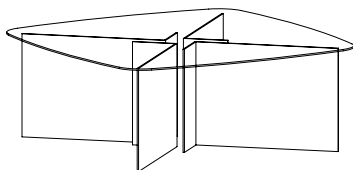

- basamento e piano extrachiaro / extra clear base and top
Gestell und Tischplatte extrahell / piètement et top extra clair
- basamento e piano fumè / smoked base and top
Gestell und Tischplatte aus Rauchglas / piètement et top fumé
- basamento e piano bronzo / bronze base and top
Gestell und Tischplatte aus Bronze Glas / piètement et top bronze

-
- Tavolo con piano in appoggio in vetro extra chiaro , fumè o bronzo temperato.
Basamento composto da elementi accostabili in vetro extra chiaro , fumè o bronzo.
 - Dining table with top in tempered extra clear, smoked or bronze glass.
Base made of combining elements in extra clear, smoked or bronze glass.
 - Esstisch mit Top aus Sicherheitsglas extrahell, Rauchglas oder Bronze Glas.
Gestell aus kombinierbaren Elementen aus extrahellem Glas, Rauchglas oder Bronze Glas.
 - Table haut avec top en verre trempé en extra clair, fumé ou bronze.
Piètement composé de éléments approchables en verre extra clair, fumé ou bronze.

	I E D F	dimensioni dimension abmessungen dimension	spessore thickness stärke épaisseur	volume volume volumen volume	carico ammesso admitted load tragfähigkeit charge admise	peso weight gewicht poids	prezzo price preis prix
		cm	mm	m3	kg	kg	euro

Thrim

design Massimo Castagna 2022

200 x 110 x h 75	10/10	0,93	150	169	□ 2.470 ■ 2.650 ■ 2.680
220 x 110 x h 75	10/10	1,02	150	187	□ 2.660 ■ 2.870 ■ 2.900
240 x 110 x h 75	10/10	1,06	150	195	□ 2.790 ■ 2.990 ■ 3.030
260 x 110 x h 75	10/10	1,11	150	209	□ 2.980 ■ 3.170 ■ 3.220
280 x 110 x h 75	10/10	1,14	150	217	□ 3.350 ■ 3.620 ■ 3.680
300 x 110 x h 75	10/10	1,34	150	236	□ 3.590 ■ 3.880 ■ 3.950
320 x 120 x h 75	10/10	1,50	150	255	□ 3.820 ■ 4.160 ■ 4.240

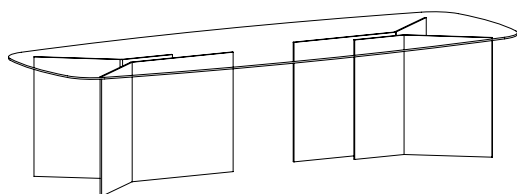

- basamento e piano extrachiaro / extra clear base and top
Gestell und Tischplatte extrahell / piètement et top extra clair
- basamento e piano fumè / smoked base and top
Gestell und Tischplatte aus Rauchglas / piètement et top fumé
- basamento e piano bronzo / bronze base and top
Gestell und Tischplatte aus Bronze Glas / piètement et top bronze

- Tavolo con piano in appoggio in vetro extra chiaro , fumè o bronzo temperato.
Basamento composto da elementi accostabili in vetro extra chiaro , fumè o bronzo.
- Dining table with top in tempered extra clear, smoked or bronze glass.
Base made of combining elements in extra clear, smoked or bronze glass.
- Esstisch mit Top aus Sicherheitsglas extrahell, Rauchglas oder Bronze Glas.
Gestell aus kombinierbaren Elementen aus extrahellem Glas, Rauchglas oder Bronze Glas.
- Table haut avec top en verre trempé en extra clair, fumé ou bronze.
Piètement composé de éléments approchables en verre extra clair, fumé ou bronze.

Thrim fused glass

design Massimo Castagna 2023

200 x 110 x h 75	10/10	0,93	150	169	■ 3.570 ■ 3.600
220 x 110 x h 75	10/10	1,02	150	187	■ 3.860 ■ 3.890
240 x 110 x h 75	10/10	1,06	150	195	■ 3.990 ■ 4.030
260 x 110 x h 75	10/10	1,11	150	209	■ 4.220 ■ 4.270
280 x 110 x h 75	10/10	1,14	150	217	■ 4.710 ■ 4.770
300 x 110 x h 75	10/10	1,34	150	236	■ 4.980 ■ 5.050
320 x 120 x h 75	10/10	1,50	150	255	■ 5.330 ■ 5.410

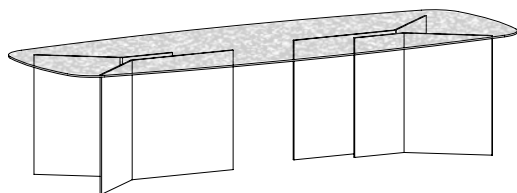

- basamento vetro fumè e piana vetro fuso fumè / base smoked glass and top fused smoked glass
Gestell Rauchglas und Top geschmolzenes Rauchglas / piètement verre fumé et top en verre en fusion fumé
- basamento vetro bronzo e piana vetro fuso bronzo / base bronze glass and top fused bronze glass
Gestell Bronze Glas und Top geschmolzenes Bronze Glas / piètement verre bronze et top verre en fusion bronze

- Tavolo con piano in appoggio in vetro fuso fumè o bronzo.
Basamento composto da elementi accostabili in vetro fumè o bronzo.
- Dining table with propped up top in fused smoked or bronze glass.
Base made of combining elements in smoked or bronze glass.
- Esstisch mit Auflage Top aus geschmolzenem Rauchglas oder Bronze Glas.
Gestell aus kombinierbaren Elementen aus Rauchglas oder Bronze Glas.
- Table haut avec top en appui en verre en fusion fumé ou bronze.
Piètement composé de éléments approchables en verre fumé ou bronze.

	I E D F	dimensioni dimension abmessungen dimension	spessore thickness stärke épaisseur	volume volume volumen volume	carico ammesso admitted load tragfähigkeit charge admise	peso weight gewicht poids	prezzo price preis prix
		cm	mm	m3	kg	kg	euro

Thrim

design Massimo Castagna 2022

200 x 100 x h 75	10/10	0,91	150	170	<input type="checkbox"/> 2.280	<input checked="" type="checkbox"/> 2.460	<input checked="" type="checkbox"/> 2.490
220 x 100 x h 75	10/10	1,01	150	188	<input type="checkbox"/> 2.420	<input checked="" type="checkbox"/> 2.620	<input checked="" type="checkbox"/> 2.660
240 x 100 x h 75	10/10	1,04	150	196	<input type="checkbox"/> 2.540	<input checked="" type="checkbox"/> 2.750	<input checked="" type="checkbox"/> 2.800
260 x 100 x h 75	10/10	1,09	150	210	<input type="checkbox"/> 2.590	<input checked="" type="checkbox"/> 2.810	<input checked="" type="checkbox"/> 2.870
280 x 100 x h 75	10/10	1,11	150	218	<input type="checkbox"/> 2.930	<input checked="" type="checkbox"/> 3.180	<input checked="" type="checkbox"/> 3.250
300 x 100 x h 75	10/10	1,31	150	237	<input type="checkbox"/> 3.130	<input checked="" type="checkbox"/> 3.410	<input checked="" type="checkbox"/> 3.490
320 x 120 x h 75	10/10	1,70	150	271	<input type="checkbox"/> 3.710	<input checked="" type="checkbox"/> 4.060	<input checked="" type="checkbox"/> 4.150

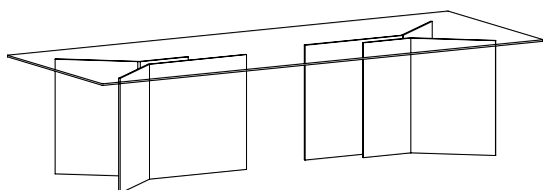

- basamento e piano extrachiaro / extra clear base and top
Gestell und Tischplatte extrahell / piètement et top extra clair
- basamento e piano fumè / smoked base and top
Gestell und Tischplatte aus Rauchglas / piètement et top fumé
- basamento e piano bronzo / bronze base and top
Gestell und Tischplatte aus Bronze Glas / piètement et top bronze

- Tavolo con piano in appoggio in vetro extra chiaro , fumè o bronzo temperato.
Basamento composto da elementi accostabili in vetro extra chiaro , fumè o bronzo.
- Dining table with top in tempered extra clear, smoked or bronze glass.
Base made of combining elements in extra clear, smoked or bronze glass.
- Esstisch mit Top aus Sicherheitsglas extrahell, Rauchglas oder Bronze Glas.
Gestell aus kombinierbaren Elementen aus extrahellem Glas, Rauchglas oder Bronze Glas.
- Table haut avec top en verre trempé en extra clair, fumé ou bronze.
Piètement composé de éléments approchables en verre extra clair, fumé ou bronze.

Ti design Gonzo-Vicari 2012	130 x 65 x h 33	15	0,39	30	64	1.480
						<input type="checkbox"/> 1.560
	150 x 75 x h 33	15	0,55	30	85	1.680
						<input type="checkbox"/> 1.860

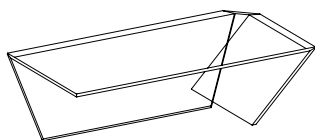

- Vetro extrachiaro / extra clear glass / Glas extrahell / verre extra claire

- Tavolo basso con fianchi inclinati. Disponibile in vetro trasparente o extrachiaro.
- Low table with inclined sides. Available in transparent or extra clear glass.
- Niedriger Tisch mit schrägen Seiten. Erhältlich in transparentem oder extrahellem Glas.
- Table bas avec cotés inclinés. Disponible en verre transparent ou extra clair.

	I E D F	dimensioni dimension abmessungen dimension	spessore thickness stärke épaisseur	volume volume volumen volume	carico ammesso admitted load tragfähigkeit charge admise	peso weight gewicht poids	prezzo price preis prix
		cm	mm	m3	kg	kg	euro

Trasparenza

design D'Urbino - Lomazzi 1998

(6) 88 x 30 x h 183	12	0,12	22*	60	1.860
(5) 88 x 30 x h 151	12	0,12	22*	52	1.590
(6) 120 x 30 x h 183	12	0,13	22*	66	1.980
(5) 120 x 30 x h 151	12	0,13	22*	55	1.710

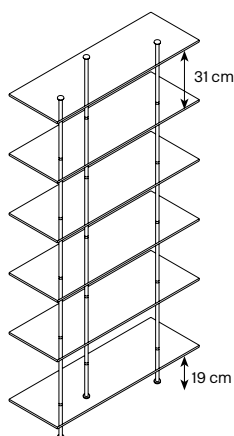

(6) / (5) ripiani / shelves / Platten / plateaux

* ogni ripiano / on each shelf / auf jedem Bord / pour chaque étagère

- Libreria a parete con supporti in metallo Inox lucidato. Disponibile a 6 - 5 ripiani.
- Wall library with supports in metal shiny stainless steel. With 6 - 5 shelves available.
- Wandregal mit Trägern aus Metall Inox glänzend. Mit 6 - 5 Böden verfügbar.
- Expositoire mural avec supports en métal Inox brillant. Disponible à 6 - 5 étagères.

Trio

design M. U.

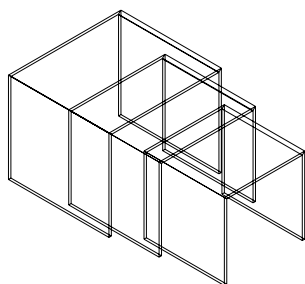

40 x 40 x h 38	12	0,146	40	20	480
					□ 510
					■ 540
					● 590
48 x 45 x h 41	12	0,193	40	24	490
					□ 530
					■ 570
					● 620
56 x 50 x h 45	12	0,257	40	30	530
					□ 580
					■ 630
					● 680

- Tris completo, come da disegno 1.500
- Complete nest of table as drawing □ 1.620
- Kompletter Dreisatz-Tisch wie Abbildung ■ 1.740
- Set de tables cicognes comme dessin ● 1.890

- vetro extrachiaro / extra clear glass / extrahelles Glas / verre extra clair
- Vetro fumé / smoked glass / Rauchglas / verre fumé
- Versione extrachiaro verniciato bianco / extra clear white lacquered version
- Version extrahell weiß lackiert / version extra clair laqué blanc

- Serie di tavolini impilabili. **Disponibili con dimensioni a richiesta.**
- Stacking tables. **Special sizes available.**
- Dreisatztisch. **Sonderanfertigungen sind möglich.**
- Petites tables superposables. **Dimensions spéciales sur demande.**

Transistor

design Barberini & Gunnell 2012

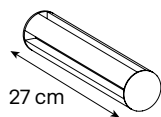

G Giunto alluminio / Aluminium joint / Joint en aluminium / Verbindungsteil in Aluminium
120

P30

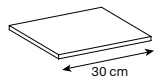

50 euro
 60 euro

P45



60 euro
 80 euro

P60

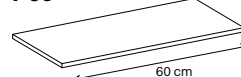

70 euro
 90 euro

P90

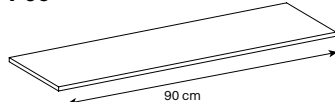

90 euro
 120 euro

P120

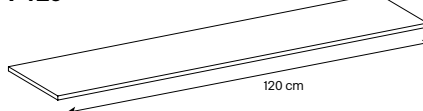

110 euro
 150 euro

L90

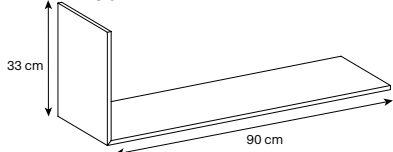

160 euro
 200 euro

S120

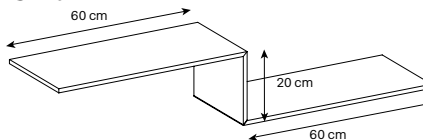

200 euro
 240 euro

T90

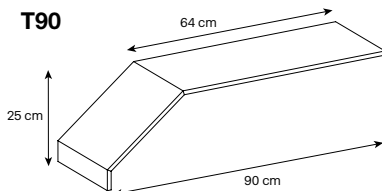

180 euro
 210 euro

T120

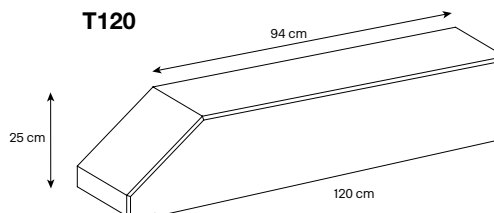

190 euro
 240 euro

vetro extrachiario / extra clear glass / Glas extrahell / verre extra clair

- Mensole modulari. Fissaggio a parete con un giunto cilindrico in alluminio. Le mensole in vetro di diversa misura e forma sono disponibili in vetro trasparente o extrachiario.
- Modular wall shelves. Wall fixing with cylindrical aluminium joints. The glass shelves in different sizes and forms are available in clear or extra clear glass.
- Modulare Wandkonsolen. Wandbefestigung mit zylindrischen Verbindungen aus Aluminium. Die Glaskonsolen in verschiedenen Maßen und Formen sind in transparentem oder extrahellem Glas erhältlich.
- Tablettes au mur modulaires. Fixation mural avec joints cylindrique en aluminium. Les tablettes en verre de différents mesures et formes sont disponible en verre clair ou extra clair.

Transistor

design Barberini & Gunnell 2012

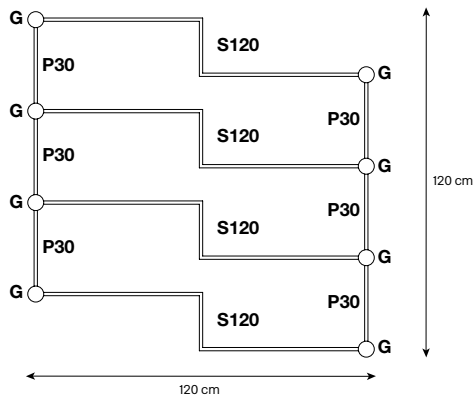

Esempio per calcolare il prezzo / Example of price calculation
Beispiel zur Preisausrechnung / Exemple pour calculer le prix

COMP. 1			
NR. 4 x S120	800	<input type="checkbox"/>	960
NR. 6 x P30	300	<input type="checkbox"/>	360
NR. 8 x G	960	<input type="checkbox"/>	960
euro	TOT. 2.060	<input type="checkbox"/>	2.280

COMP. 1 2.060 2.280 euro

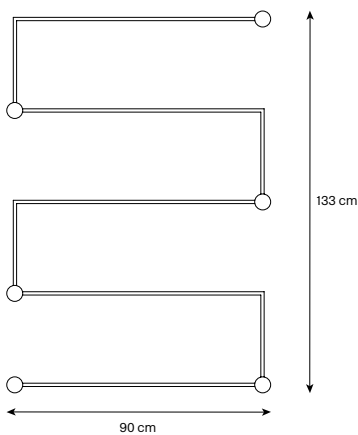

COMP. 2 1.450 1.640 euro

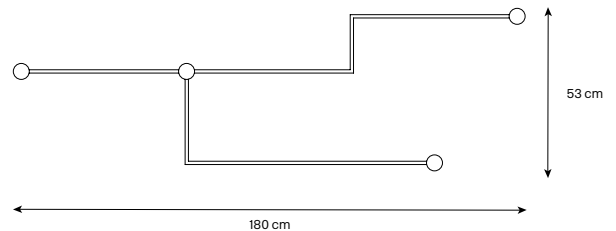

COMP. 3 910 1.010 euro

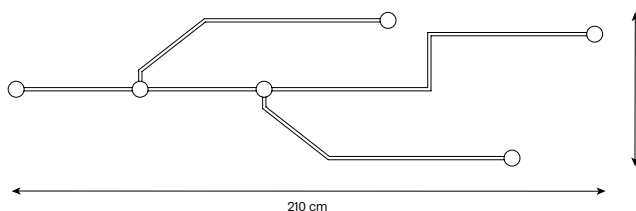

COMP. 4 1.400 1.540 euro

ATTENZIONE i giunti di alluminio „G“ vanno utilizzati ad ognuna delle due estremità delle mensole di vetro.

ATTENTION: aluminium joints „G“ have to be used on each end of the glass shelves

ACHTUNG: die Verbindungen aus Aluminium müssen an jeder der zwei äußersten Konsolenenden benutzt werden.

ATTENTION: les joints en Aluminium „G“ doivent être utilisés sur chaque extrémité des consoles en verre

Carico ammesso: 10 kg. ogni mensola di vetro

Admitted load: 10kg for each glass shelf

Tragfähigkeit: 10kg für jede Glaskonsole

Charge admise: 10kg pour chaque console en verre

vetro extrachiaro / extra clear glass / Glas extrahell / verre extra clair

- Mensole modulari. Fissaggio a parete con un giunto cilindrico in alluminio. Le mensole in vetro di diversa misura e forma sono disponibili in vetro trasparente o extrachiaro.
- Modular wall shelves. Wall fixing with cylindrical aluminium joints. The glass shelves in different sizes and forms are available in clear or extra clear glass.
- Modulare Wandkonsolen. Wandbefestigung mit zylindrischen Verbindungen aus Aluminium. Die Glaskonsolen in verschiedenen Maßen und Formen sind in transparentem oder extrahellem Glas erhältlich.
- Tablettes au mur modulaires. Fixation mural avec joints cylindrique en aluminium. Les tablettes en verre de différents mesures et formes sont disponible en verre clair ou extra clair.

	I E D F	dimensioni dimension abmessungen dimension	spessore thickness stärke épaisseur	volume volume volumen volume	carico ammesso admitted load tragfähigkeit charge admise	peso weight gewicht poids	prezzo price preis prix
		cm	mm	m3	kg	kg	euro

Unity

design Karim Rashid 2010

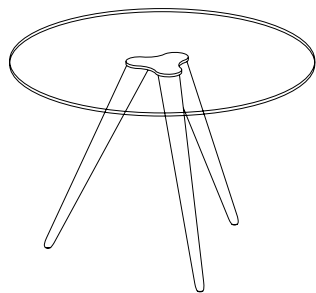

GAMBE VERNICIATE BIANCO/LEGS WHITE LACQUERED/BEINE WEISS LACKIERT/PIEDS LAQUE BLANC

Ø 110 x h 74	12	0,15	150	71	1.790
					■ 1.950
					□ 1.900
Ø 120 x h 74	12	0,17	150	77	1.880
					■ 2.080
					□ 2.010
Ø 130 x h 74	12	0,18	150	83	1.980
					■ 2.210
					□ 2.130

GAMBE CROMATE/LEGS IN CHROMED METAL/BEINE AUS METALL VERCHROMT/PIEDS EN METAL CHROME

Ø 110 x h 74	12	0,15	150	71	2.090
					■ 2.240
					□ 2.180
Ø 120 x h 74	12	0,17	150	77	2.170
					■ 2.350
					□ 2.280
Ø 130 x h 74	12	0,18	150	83	2.290
					■ 2.500
					□ 2.430

- Top vetro trasparente / Transparent glass top / Glasplatte transparent / Plateau en verre transparent
- Top vetro fumè / Smoked glass top / Rauchglasplatte / Plateau en verre fumè
- Top vetro extrachiaro / Extraclear glass top / Glasplatte extrahell / Plateau en verre extra clair

- Tavolo alto in vetro temperato, con gambe in metallo cromato o verniciato bianco. Piedino in PVC per regolazione.
- High table in tempered glass, legs in chrome plated metal or white lacquered. Adjustable little feet of PVC.
- Eßtisch aus Sicherheitsglas, Beine aus verchromtem Metall oder weiß lackiert. PVC regelbare Füße.
- Table haute en verre trempé, pieds en metal chromé ou laqués blanc. Petits pieds en PVC réglables.

	I E D F	dimensioni dimension abmessungen dimension	spessore thickness stärke épaisseur	volume volume volumen volume	carico ammesso admitted load tragfähigkeit charge admise	peso weight gewicht poids		prezzo price preis prix
		cm	mm	m3	kg	kg		euro

Updown

design Martina Castagna 2023

G

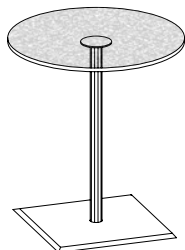

M

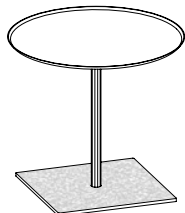

G	Ø 35 x h 35	10	0,06	15	9	○ 1.280 ■ 1.240 ■ 1.260
M	Ø 35 x h 35	10	0,06	15	9	○ 1.300 ■ 1.260 ■ 1.280
G	Ø 35 x h 50	10	0,06	15	9	○ 1.320 ■ 1.280 ■ 1.300
M	Ø 35 x h 50	10	0,06	15	9	○ 1.340 ■ 1.300 ■ 1.320
G	Ø 35 x h 65	10	0,06	15	9	○ 1.360 ■ 1.320 ■ 1.340
M	Ø 35 x h 65	10	0,06	15	9	○ 1.380 ■ 1.340 ■ 1.360
G	Ø 45 x h 35	10	0,07	15	12	○ 1.440 ■ 1.400 ■ 1.420
M	Ø 45 x h 35	10	0,07	15	12	○ 1.460 ■ 1.420 ■ 1.440
G	Ø 45 x h 50	10	0,07	15	12	○ 1.480 ■ 1.440 ■ 1.460
M	Ø 45 x h 50	10	0,07	15	12	○ 1.500 ■ 1.460 ■ 1.480
G	Ø 45 x h 65	10	0,07	15	12	○ 1.520 ■ 1.480 ■ 1.500
M	Ø 45 x h 65	10	0,07	15	12	○ 1.540 ■ 1.500 ■ 1.520
G	Ø 55 x h 35	10	0,08	15	16	○ 1.520 ■ 1.480 ■ 1.500
M	Ø 55 x h 35	10	0,08	15	15	○ 1.540 ■ 1.500 ■ 1.520
G	Ø 55 x h 50	10	0,08	15	16	○ 1.560 ■ 1.520 ■ 1.540
M	Ø 55 x h 50	10	0,08	15	15	○ 1.580 ■ 1.540 ■ 1.520
G	Ø 55 x h 65	10	0,08	15	16	○ 1.600 ■ 1.560 ■ 1.580
M	Ø 55 x h 65	10	0,08	15	15	○ 1.620 ■ 1.580 ■ 1.600

specificare sempre la finitura del top o della base in vetro fuso FUMÈ, BRONZO, VERDE CHIARO, VERDE SALVIA, VERDE OLIVA.

always specify finish of top or base in fused glass SMOKED, BRONZE, VERDE CHIARO, VERDE SALVIA, VERDE OLIVA.

immer Ausführung von Top oder Gestell aus geschmolzenem Glas angeben, RAUCHGLAS, BRONZE, VERDE CHIARO, VERDE SALVIA, VERDE OLIVA.

toujours spécifier finition du top ou base en verre en fusion FUME, BRONZE, VERDE CHIARO, VERDE SALVIA, VERDE OLIVA.

- vetro fuso verde /fused green glass /geschmolzenes Grün Glas /verre en fusion vert
- vetro fuso fumè /fused smoked glass / geschmolzenes Rauchglas /verre en fusion fumé
- vetro fuso bronzo /fused bronze glass /geschmolzenes Bronze Glas /verre en fusion bronze

- Tavolini a stelo centrale in finitura champagne metallizzato. Top in vetro fuso fumè, bronzo e tre tonalità di verde semitrasparente o in metallo con profilo sagomato in finitura champagne. Basi in vetro fuso fumè, bronzo e laccato in tre tonalità di verde o in metallo con profilo sagomato in finitura champagne.
- Small tables with central stem in metallised champagne finish. Top in fused glass smoked, bronze and three shades of semi-transparent green or in metal with shaped profile in champagne finish. Bases in fused glass smoked, bronze and lacquered in three shades of green or in metal with shaped profile in champagne finish.
- Tischchen mit zentralem Stamm in metallisierter Champagnerfarbe. Top aus geschmolzenem Glas in Rauchglas, Bronze und drei halbtransparente Grüntöne oder aus Metall mit Profilsseite Ausführung Champagnerfarbe. Grundplatte aus geschmolzenem Glas in Rauchglas, Bronze und drei lackierten Grüntöne oder aus Metall mit Profilsseite Ausführung Champagnerfarbe.
- Petites tables avec tige central en finition champagne métallisé. Top en verre en fusion fumé, bronze et trois nuances semi-transparent de vert ou en métal avec profil modelé en finition champagne. Base en verre en fusion fumé, bronze et laqué en trois nuances de vert ou en métal avec profil modelé en finition champagne.

	I E D F	dimensioni dimension abmessungen dimension	spessore thickness stärke épaisseur	volume volume volumen volume	carico ammesso admitted load tragfähigkeit charge admise	peso weight gewicht poids	prezzo price preis prix
		cm	mm	m3	kg	kg	euro

Updown

design Martina Castagna 2023

G

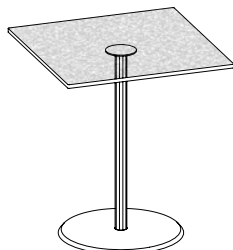

M

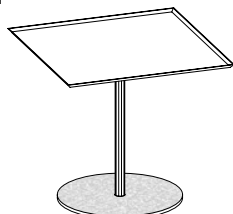

G	35 x 35 x h 35	10	0,06	15	9	○ 1.340 ■ 1.300 ■ 1.320
M	35 x 35 x h 35	10	0,06	15	9	○ 1.360 ■ 1.320 ■ 1.340
G	35 x 35 x h 50	10	0,06	15	9	○ 1.380 ■ 1.340 ■ 1.360
M	35 x 35 x h 50	10	0,06	15	9	○ 1.400 ■ 1.360 ■ 1.380
G	35 x 35 x h 65	10	0,06	15	9	○ 1.420 ■ 1.380 ■ 1.400
M	35 x 35 x h 65	10	0,06	15	9	○ 1.440 ■ 1.400 ■ 1.420
G	45 x 45 x h 35	10	0,07	15	12	○ 1.500 ■ 1.460 ■ 1.480
M	45 x 45 x h 35	10	0,07	15	10	○ 1.520 ■ 1.480 ■ 1.500
G	45 x 45 x h 50	10	0,07	15	12	○ 1.540 ■ 1.500 ■ 1.520
M	45 x 45 x h 50	10	0,07	15	10	○ 1.560 ■ 1.520 ■ 1.540
G	45 x 45 x h 65	10	0,07	15	12	○ 1.560 ■ 1.520 ■ 1.540
M	45 x 45 x h 65	10	0,07	15	10	○ 1.580 ■ 1.540 ■ 1.560
G	55 x 55 x h 35	10	0,08	15	17	○ 1.580 ■ 1.540 ■ 1.560
M	55 x 55 x h 35	10	0,08	15	15	○ 1.600 ■ 1.560 ■ 1.580
G	55 x 55 x h 50	10	0,08	15	17	○ 1.620 ■ 1.580 ■ 1.600
M	55 x 55 x h 50	10	0,08	15	15	○ 1.640 ■ 1.600 ■ 1.620
G	55 x 55 x h 65	10	0,08	15	17	○ 1.660 ■ 1.620 ■ 1.640
M	55 x 55 x h 65	10	0,08	15	15	○ 1.680 ■ 1.640 ■ 1.660

specificare sempre la finitura del top o della base in vetro fuso FUMÈ, BRONZO, VERDE CHIARO, VERDE SALVIA, VERDE OLIVA.

always specify finish of top or base in fused glass SMOKED, BRONZE, VERDE CHIARO, VERDE SALVIA, VERDE OLIVA.

immer Ausführung von Top oder Gestell aus geschmolzenem Glas angeben, RAUCHGLAS, BRONZE, VERDE CHIARO, VERDE SALVIA, VERDE OLIVA.

toujours spécifier finition du top ou base en verre en fusion FUME, BRONZE, VERDE CHIARO, VERDE SALVIA, VERDE OLIVA.

- vetro fuso verde /fused green glass /geschmolzenes Grün Glas /verre en fusion vert
- vetro fuso fumè /fused smoked glass / geschmolzenes Rauchglas /verre en fusion fumé
- vetro fuso bronzo /fused bronze glass /geschmolzenes Bronze Glas /verre en fusion bronze

- Tavolini a stelo centrale in finitura champagne metallizzato. Top in vetro fuso fumè, bronzo e tre tonalità di verde semitrasparente o in metallo con profilo sagomato in finitura champagne. Basi in vetro fuso fumè, bronzo e laccato in tre tonalità di verde o in metallo con profilo sagomato in finitura champagne.
- Small tables with central stem in metallised champagne finish. Top in fused glass smoked, bronze and three shades of semi-transparent green or in metal with shaped profile in champagne finish. Bases in fused glass smoked, bronze and lacquered in three shades of green or in metal with shaped profile in champagne finish.
- Tischchen mit zentralem Stamm in metallisierter Champagnerfarbe. Top aus geschmolzenem Glas in Rauchglas, Bronze und drei halbtransparente Grüntöne oder aus Metall mit Profilsseite Ausführung Champagnerfarbe. Grundplatte aus geschmolzenem Glas in Rauchglas, Bronze und drei lackierten Grüntöne oder aus Metall mit Profilsseite Ausführung Champagnerfarbe.
- Petites tables avec tige central en finition champagne métallisé. Top en verre en fusion fumé, bronze et trois nuances semi-transparent de vert ou en métal avec profil modelé en finition champagne. Base en verre en fusion fumé, bronze et laqué en trois nuances de vert ou en métal avec profil modelé en finition champagne.

	I E D F	dimensioni dimension abmessungen dimension	spessore thickness stärke épaisseur	volume volume volumen volume	carico ammesso admitted load tragfähigkeit charge admise	peso weight gewicht poids	prezzo price preis prix
		cm	mm	m3	kg	kg	euro

Welcome

design Uto Balmoral 2017

90 x h 195 x 12	4 / 5	0,41		70	● 1.690
					●● 1.810

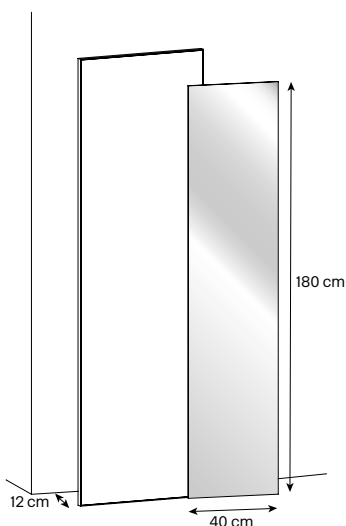

- Versione con specchio standard / standard mirror version/ Standardspiegel/ version miror standard
- Versione con specchio fumè o bronzo/smoked or bronze mirror version version Bronze-oder Rauchglasspiegel/version miroir bronze ou fumè

Optional kit 3 appendiabiti in metallo: oro spazzolato, bronzo spazzolato e rame spazzolato. 480

Specificare sempre la finitura del kit appendiabiti

Optional kit 3 metal coat hangers: brushed gold, brushed bronze and brushed copper.

Always specify coat hanger finish

Optional kit 3 Metallkleiderbügel: gebürstetes Gold, gebürstete Bronze und gebürsteter Kupfer.

Immer Ausfertigung der Kleiderbügel angeben

Kit optionnel 3 portemanteau en métal: or brossé, bronze brossé e cuivre brossé.

Spécifier toujours finition du kit portemanteau.

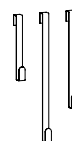

- Specchio da parete nelle seguenti finiture: standard, bronzo o fumè. Abbinato alle seguenti ceramiche: **Pietra di Savoia antracite bocciardato, Noir desir lucido o opaco, Emperador lucido o opaco, Calacatta oro venato lucido, Pietra Grey lucido o opaco, Sahara noir lucido o bocciardato.** Optional appendiabiti in metallo spazzolato in diverse finiture: bronzo, rame o oro.
- Wall mirror in following finishes: standard, bronze or smoked. Combined with following ceramics: **Pietra di Savoia anthracite bocciardato, Noir desir polished or matt, Emperador polished or matt, Calacatta oro venato polished, Pietra Grey polished or matt, Sahara noir polished or bocciardato.** Optional brushed metal coat hangers in several finishes: bronze, copper and gold.
- Wandspiegel in folgenden Ausführungen: Standard, Bronze oder Rauchglasspiegel. Mit folgenden Keramikausführungen kombiniert: **Pietra di Savoia Anthrazit bocciardato, Noir desir glänzend oder matt, Emperador glänzend oder matt, Calacatta oro venato glänzend, Pietra Grey glänzend oder matt, Sahara noir glänzend oder bocciardato.** Optional Kleiderbügel aus gebürstetem Metall: Bronze, Kupfer und Gold.
- Miroir au mur dans les suivants finitions: standard, bronze ou fumé. Associé aux suivants céramiques: **Pietra di Savoia anthracite mat, Noir desir brillant ou mat, Emperador brillant ou mat, Calacatta oro venato brillant, Pietra Grey brillant ou mat, Sahar noir brillant ou bocciardato.** Optionnel portemanteau en métal brossé: bronze, cuivre ou or.

VU 90

design G.T. Garattoni 2013

30 x 9 x h 90	10/12/15/20	0,04		32	1.880
30 x 3 x h 90	5	0,03		4	● 280

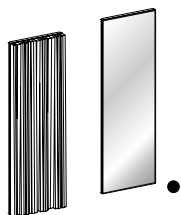

- solo specchio / only mirror / nur Spiegel / seulement miroir

- Specchio Modulare, realizzato con fasce di vetro extrachiaro incollate tra di loro. Disponibile in due misure.
- Modular mirror, made with extra clear glass strips glued together. Available in two sizes
- Modularer Spiegel, aus extrahellen zusammengeklebten Glasstreifen. In zwei Maßen erhältlich.
- Miroir modulaire, réalisé avec bandes de verre extra clair collés. Disponible en deux mesures.

VU 200

design G.T. Garattoni 2013

30 x 9 x h 200	10/12/15/20	0,09		69	3.400
30 x 3 x h 200	5	0,06		10	● 520

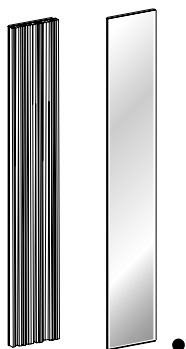

- solo specchio / only mirror / nur Spiegel / seulement miroir

- Specchio Modulare, realizzato con fasce di vetro extrachiaro incollate tra di loro. Disponibile in due misure.
- Modular mirror, made with extra clear glass strips glued together. Available in two sizes.
- Modularer Spiegel, aus extrahellen zusammengeklebten Glasstreifen. In zwei Maßen erhältlich.
- Miroir modulaire, réalisé avec bandes de verre extra clair collés. Disponible en deux mesures.

	I E D F	dimensioni dimension abmessungen dimension	spessore thickness stärke épaisseur	volume volume volumen volume	carico ammesso admitted load tragfähigkeit charge admise	peso weight gewicht poids	prezzo price preis prix
		cm	mm	m3	kg	kg	euro

WG System

design Massimo Castagna 2023



B1 120 x 46 x h 16	10	0,21		38	<input type="checkbox"/>	690
					<input checked="" type="checkbox"/>	710
					<input checked="" type="checkbox"/>	720



B2 120 x 60 x h 16	10	0,25		48	<input type="checkbox"/>	790
					<input checked="" type="checkbox"/>	820
					<input checked="" type="checkbox"/>	830



B3 120 x 46 x h 30	10	0,40		41	<input type="checkbox"/>	750
					<input checked="" type="checkbox"/>	780
					<input checked="" type="checkbox"/>	790



B4 120 x 60 x h 30	10	0,51		52	<input type="checkbox"/>	870
					<input checked="" type="checkbox"/>	900
					<input checked="" type="checkbox"/>	910



B5 179 x 46 x h 16	10	0,30		60	<input type="checkbox"/>	920
					<input checked="" type="checkbox"/>	960
					<input checked="" type="checkbox"/>	970



B6 179 x 60 x h 16	10	0,39		76	<input type="checkbox"/>	1.020
					<input checked="" type="checkbox"/>	1.060
					<input checked="" type="checkbox"/>	1.070



B7 179 x 46 x h 30	10	0,56		66	<input type="checkbox"/>	950
					<input checked="" type="checkbox"/>	990
					<input checked="" type="checkbox"/>	1.000



B8 179 x 60 x h 30	10	0,73		82	<input type="checkbox"/>	1.110
					<input checked="" type="checkbox"/>	1.150
					<input checked="" type="checkbox"/>	1.160

Sovrapprezzo per n. 01 foro per passaggio cavi / surcharge for n. 01 cable ducting hole
 Aufpreis für Nr. 01 Kabeldurchführung / supplément pour n. 01 trou passe-câble

80

- Vetro extrachiaro / extra clear glass / extrahelles Glas / verre extra clair
- Vetro fumé / smoked glass / Rauchglas / verre fumé
- Vetro bronzo / bronze glass / Bronze Glas / Verre bronze

- Elementi a ponte, ad uso base o piano di appoggio, in vetro saldato extrachiaro, fumé o bronzo. Fori passacavo a richiesta, indicare sempre la posizione.
- Bridge-like elements used as base or countertop, in glued extra clear, smoked or bronze glass. On request cable ducting hole, always indicate position.
- Brückenformige Elemente zur Verwendung als Grundelement oder Ablage, aus verklebtem extrahellem Glas, Rauchglas oder Bronze Glas. Auf Anfrage Kabeldurchführung, immer Position angeben.
- Eléments à pont à usage base ou plan d'appui, en verre collé extra clair, fumé ou bronze. Sur demande trou passe-câble, indiquer toujours la position.

	I E D F	dimensioni dimension abmessungen dimension	spessore thickness stärke épaisseur	volume volume volumen volume	carico ammesso admitted load tragfähigkeit charge admise	peso weight gewicht poids	prezzo price preis prix
		cm	mm	m3	kg	kg	euro

WG System

design Massimo Castagna 2023

WG-61



P1 61 x 46 x h 37	10	0,19	40	41	□ 750 ■ 780 ■ 790
-------------------	----	------	----	----	-------------------------

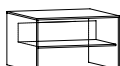

P2 61 x 60 x h 37	10	0,24	40	47	□ 850 ■ 880 ■ 890
-------------------	----	------	----	----	-------------------------

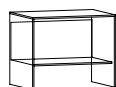

P3 61 x 46 x h 50	10	0,25	40	49	□ 820 ■ 850 ■ 860
-------------------	----	------	----	----	-------------------------



P4 64 x 60 x h 50	10	0,32	40	59	□ 930 ■ 960 ■ 970
-------------------	----	------	----	----	-------------------------

WG-120



P5 120 x 46 x h 37	10	0,36	45	64	□ 1.080 ■ 1.120 ■ 1.130
--------------------	----	------	----	----	-------------------------------



P6 120 x 60 x h 37	10	0,46	45	72	□ 1.220 ■ 1.260 ■ 1.270
--------------------	----	------	----	----	-------------------------------



P7 120 x 46 x h 50	10	0,48	45	74	□ 1.190 ■ 1.230 ■ 1.240
--------------------	----	------	----	----	-------------------------------



P8 120 x 60 x h 50	10	0,62	45	84	□ 1.320 ■ 1.370 ■ 1.380
--------------------	----	------	----	----	-------------------------------

WG-179



P9 179 x 46 x h 37	10	0,51	50	86	□ 1.440 ■ 1.490 ■ 1.500
--------------------	----	------	----	----	-------------------------------



P10 179 x 60 x h 37	10	0,69	50	98	□ 1.600 ■ 1.650 ■ 1.660
---------------------	----	------	----	----	-------------------------------



P11 179 x 46 x h 50	10	0,70	50	100	□ 1.540 ■ 1.590 ■ 1.600
---------------------	----	------	----	-----	-------------------------------



P12 179 x 60 x h 50	10	0,91	50	114	□ 1.730 ■ 1.780 ■ 1.790
---------------------	----	------	----	-----	-------------------------------

Sovrapprezzo per n. 01 foro per passaggio cavi / surcharge for no. 01 cable ducting hole
Aupreis für Nr. 01 Kabeldurchführung / supplément pour n. 01 trou passe-câble

80

- Vetro extrachiaro / extra clear glass / extrahelles Glas / verre extra clair
- Vetro fumé / smoked glass / Rauchglas / verre fumé
- Vetro bronzo / bronze glass / Bronze Glas / Verre bronze





- Sistema modulare di elementi in vetro saldato extrachiaro, fumé o bronzo con ripiano e schienale per alloggiare contenitori e optional in legno di pagina 155. Fori passacavo a richiesta, indicare sempre la posizione.
- Modular system of elements in glued glass extra clear, smoked or bronze with shelf and back panel to accommodate wooden storage units and optional elements of page 155. On request cable ducting hole, always indicate position.
- Modulares System aus verklebten Glaselementen in extrahell, Rauchglas oder Bronze mit Fach und Rückwand für Integrierung von Behältern und optionalen Elementen aus Holz siehe Seite 155. Auf Anfrage Kabeldurchführung, immer Position angeben.
- Système modulaire de éléments en verre collé extra clair, fumé ou bronze avec étagère et dos pour accueillir conteneurs et optionnels en bois de la page 155. Sur demande trou passe-câble, indiquer toujours la position.

	I E D F	dimensioni dimension abmessungen dimension	spessore thickness stärke épaisseur	volume volume volumen volume	carico ammesso admitted load tragfähigkeit charge admise	peso weight gewicht poids	prezzo price preis prix
		cm	mm	m3	kg	kg	euro

WG System

design Massimo Castagna 2023

OPTIONAL PER SISTEMA MODULARE DI PAG. 154
 OPTIONALS FOR MODULAR SYSTEM OF PAGE 154
 OPTIONALE ELEMENTE FÜR MODULARES SYSTEM AUF SEITE 154
 OPTIONS POUR SYSTEM MODULAIRE DE LA PAGE 154

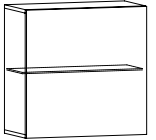
EG1		59 x 45 x h 13		0,06	10	7	320
Elemento a giorno / open element / offenes Element / élément ouvert							
CB1		59 x 45 x h 13		0,06	10	16	680
Cassetto / drawer / Schublade / tiroir							
CA2		59 x 45 x h 26		0,11	15	20	980
Cassettone /jumbo drawer /große Schublade / tiroir grande							
ER1		59 x 45 x h 26		0,11	15	13	890
Contenitore a ribalta / storage unit with flap door / Schließfach mit Klapptür / récipient avec porte à abattant							
EB1		60 x 30 x h 60		0,21	20	38	1.280
Contenitore battente in appoggio con ripiano interno in vetro countertop storage unit with hinge door and internal glass shelf auflegendes Schließfach mit Flügeltür und inneres Glasfach récipient en appui avec porte à battant et étagère en verre							

Sovrapprezzo per n. 01 foro per passaggio cavi, completo di passacavo **120**
 surcharge for no. 01 cable ducting hole, including cable duct
 Aufpreis für Nr. 01 Kabeldurchführung inkl. Lochdeckel
 supplément pour n. 01 trou passe-câble inclu couverture trou.

Specificare la finitura in legno dei contenitori e degli optional SIBERIAN ASH, EUCALIPTO o ROVERE NATURALE
 Specify wood finish of storage unit and optional elements SIBERIAN ASH, EUCALIPTO or NATURAL OAK
 Holzausführung der Behälter und optionalen Teile angeben SIBERIAN ASH, EUCALIPTO oder EICHE NATUR
 Indiquer finition bois des récipients et des éléments optionnels SIBERIAN ASH, EUCALIPTO ou ROUVRE NATUREL

- Optional in legno Siberian Ash, Eucalipto o Rovere Naturale per elementi di pag. 154.
Fori passacavo a richiesta, indicare sempre la posizione.
- Optional in wood Siberian Ash, Eucalipto or Natural Oak for elements of page 154.
On request cable ducting hole, always indicate position.
- Optionale Elemente in Holz Siberian Ash, Eucalipto oder Natureiche für Element auf Seite 154.
Auf Anfrage Kabeldurchführung, immer Position angeben.
- Optionnels en bois Siberian Ash, Eucalipto ou Rouvre Naturel pour les éléments de page 154.
Sur demande trou passe-câble, toujours indiquer position.

	M1 120 x 30 x h 5	4	0,06	40	30	● 590 ●● 660 ●●● 670
	M2 180 x 30 x h 5	4	0,09	45	44	● 830 ●● 910 ●●● 920
	M3 240 x 30 x h 5	4	0,12	50	60	● 980 ●● 1.080 ●●● 1.090

- Specchio / Mirror / Spiegel / Miroir
- Specchio fumè / Smoked mirror / Rauchglasspiegel / miroir fumé
- Specchio bronzo / Bronze mirror / Bronze Spiegel / Miroir bronze

- Mensole a parete rivestite in specchio, specchio fumè e specchio bronzo.
- Wall shelves covered in mirror, smoked mirror and bronze mirror.
- Wandkonsolen beschichte mit Spiegel, Rauchglasspiegel und Bronze Spiegel.
- Etagère au mur revêtu en miroir, miroir fumé et miroir bronze.

WG System

design Massimo Castagna 2023

- Esempi di configurazione
- Composition examples
- Kompositionsbeispiele
- Exemples de composition

WG-61

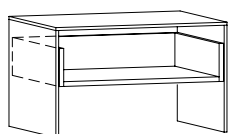

S1

61 x 46 x h 37
P1+EG1

- 1.070
- 1.100
- 1.110

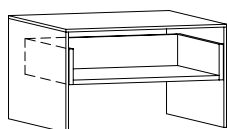

S2

61 x 60 x h 37
P2+EG1

- 1.170
- 1.200
- 1.210

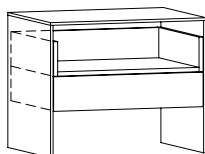

S3

61 x 46 x h 50
P3+EG1+CB1

- 1.820
- 1.850
- 1.860

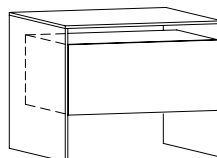

S4

61 x 60 x h 50
P4+CA2

- 1.910
- 1.940
- 1.950

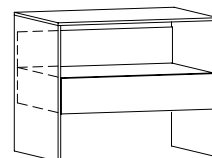

S5

61 x 46 x h 50
P3+CB1

- 1.500
- 1.530
- 1.540

WG-120

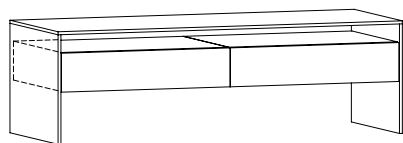

S10

120 x 46 x h 37
P5+2 CB1

- 2.440
- 2.480
- 2.490

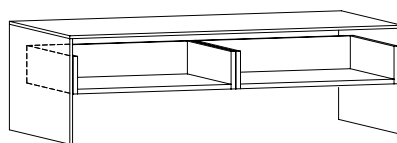

S11

120 x 60 x h 37
P6+2 EG1

- 1.860
- 1.900
- 1.910

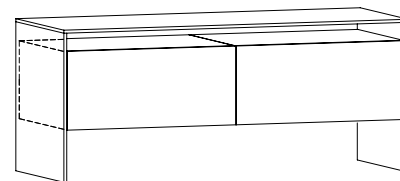

S12

120 x 46 x h 50
P5+2 ER1

- 2.860
- 2.900
- 2.910

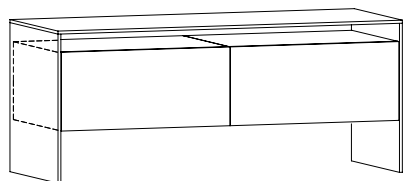

S13

120 x 46 x h 50
P7+2 CA2

- 3.150
- 3.190
- 3.200

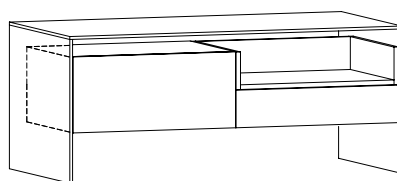

S14

120 x 60 x h 50
P8+ER1+CB1+EG1

- 3.210
- 3.260
- 3.270

- Vetro extrachiaro / extra clear glass / extrahelles Glas / verre extra clair
- Vetro fumé / smoked glass / Rauchglas / verre fumé
- Vetro bronzo / bronze glass / Bronze Glas / Verre bronze

WG System

design Massimo Castagna 2023

- Esempi di configurazione
- Composition examples
- Kompositionsbeispiele
- Exemples de composition

WG-179

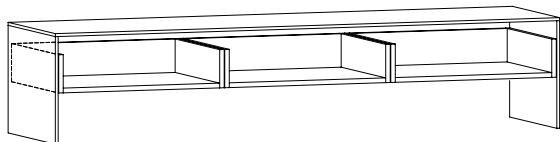

S20
179 x 46 x h 37
P9+3 EG1
□ 2.400
■ 2.450
■ 2.460

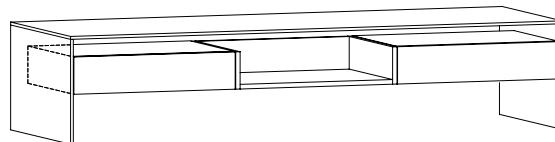

S21
179 x 60 x h 37
P10+EG1+2 CB1
□ 3.280
■ 3.330
■ 3.340

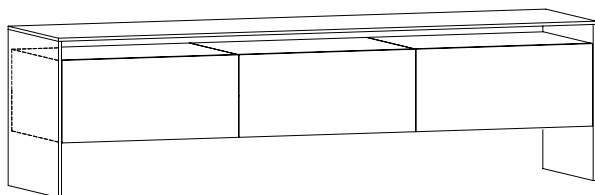

S22
179 x 46 x h 50
P11+3 CA2
□ 4.480
■ 4.530
■ 4.540

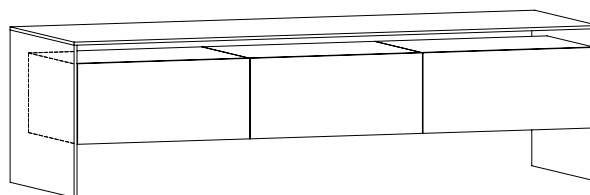

S23
179 x 60 x h 50
P12+3 ER1
□ 4.400
■ 4.450
■ 4.460

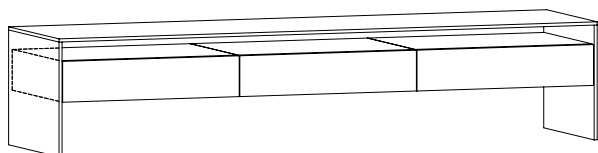

S24
179 x 46 x h 37
P9+3 CB1
□ 3.480
■ 3.530
■ 3.540

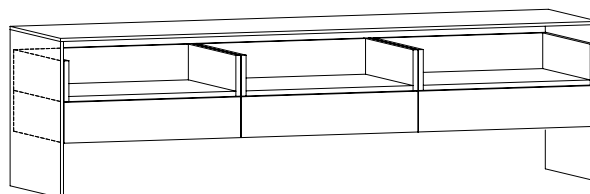

S25
179 x 46 x h 50
P11+3 CB1+3 EG1
□ 4.540
■ 4.590
■ 4.600

- Vetro extrachiaro / extra clear glass / extrahelles Glas / verre extra clair
- Vetro fumé / smoked glass / Rauchglas / verre fumé
- Vetro bronzo / bronze glass / Bronze Glas / Verre bronze

WG System

design Massimo Castagna 2023

Composizioni / compositions / Kompositionen / compositions

COMP 1

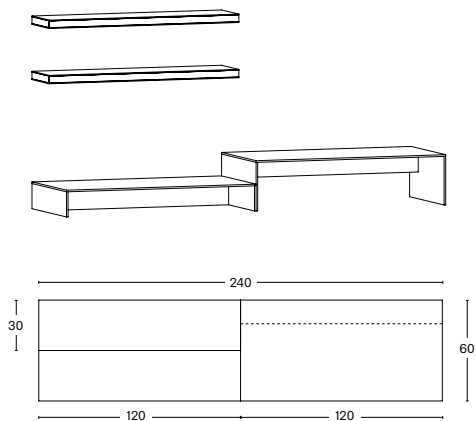

			□	■	■
2	M1	120x30xH5	590	660	670
1	B2	120x60xH16	790	820	830
1	B4	120x60xH30	870	900	910
TOTALE COMPOSIZIONE / TOTAL LAYOUT			2.840	3.040	3.080

- Vetro extrachiaro / extra clear glass / extrahelles Glas / verre extra clair
- Vetro fumé / smoked glass / Rauchglas / verre fumé
- Vetro bronzo / bronze glass / Bronze Glas / Verre bronze

COMP 2

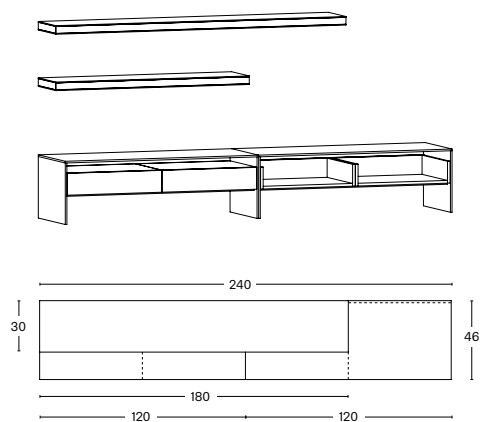

			□	■	■
1	M2	180x30xH5	830	910	920
1	M1	120x30xH5	590	660	670
1	P7	120x46xH50	1.190	1.230	1.240
2	CB1	59x45xH13	680		
1	P7	120x46xH50	1.190	1.230	1.240
2	EG1	59x45xH13	320		
TOTALE COMPOSIZIONE / TOTAL LAYOUT			5.800	6.030	6.070

- Vetro extrachiaro / extra clear glass / extrahelles Glas / verre extra clair
- Vetro fumé / smoked glass / Rauchglas / verre fumé
- Vetro bronzo / bronze glass / Bronze Glas / Verre bronze

COMP 3

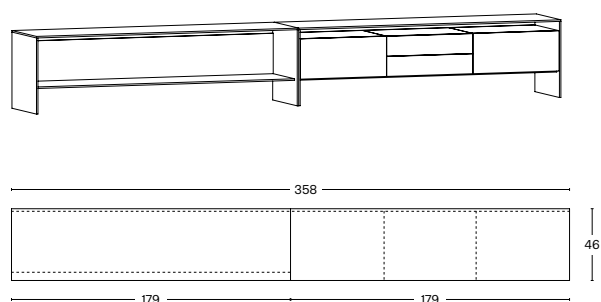

			□	■	■
1	P11	179x46xH50	1.540	1.590	1.600
1	P11	179x46xH50	1.540	1.590	1.600
2	ER1	59x45xH26	890		
2	CB1	59x45xH13	680		
TOTALE COMPOSIZIONE / TOTAL LAYOUT			6.220	6.320	6.340

- Vetro extrachiaro / extra clear glass / extrahelles Glas / verre extra clair
- Vetro fumé / smoked glass / Rauchglas / verre fumé
- Vetro bronzo / bronze glass / Bronze Glas / Verre bronze

WG System

design Massimo Castagna 2023

Composizioni / compositions / Kompositionen / compositions

COMP 4

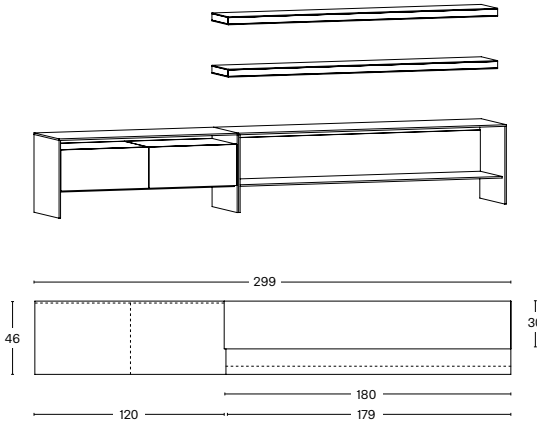

			□	■	■
2	M2	180x30xH5	830	910	920
1	P7	120x46xH50	1.190	1.230	1.240
2	ER1	59x45xH26	890		
1	P11	179x46xH50	1.540	1.590	1.600
TOTALE COMPOSIZIONE / TOTAL LAYOUT			6.170	6.420	6.460

- Vetro extrachiaro / extra clear glass / extrahelles Glas / verre extra clair
- Vetro fumé / smoked glass / Rauchglas / verre fumé
- Vetro bronzo / bronze glass / Bronze Glas / Verre bronze

COMP 5

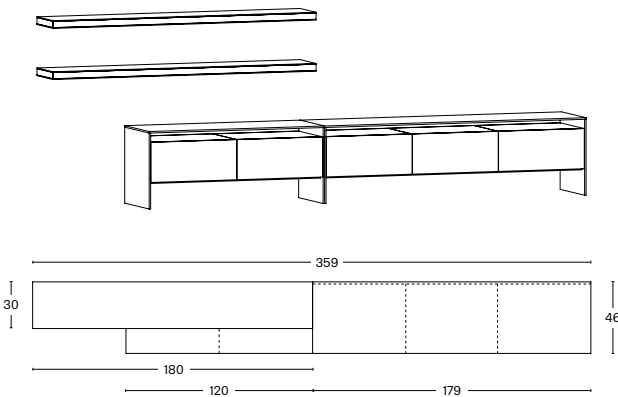

			□	■	■
2	M2	180x30xH5	830	910	920
1	P7	120x46xH50	1.190	1.230	1.240
2	CA2	59x45xH26	980		
1	P11	179x46xH50	1.540	1.590	1.600
3	ER1	59x45xH26	890		
TOTALE COMPOSIZIONE / TOTAL LAYOUT			9.020	9.270	9.300

- Vetro extrachiaro / extra clear glass / extrahelles Glas / verre extra clair
- Vetro fumé / smoked glass / Rauchglas / verre fumé
- Vetro bronzo / bronze glass / Bronze Glas / Verre bronze

COMP 6

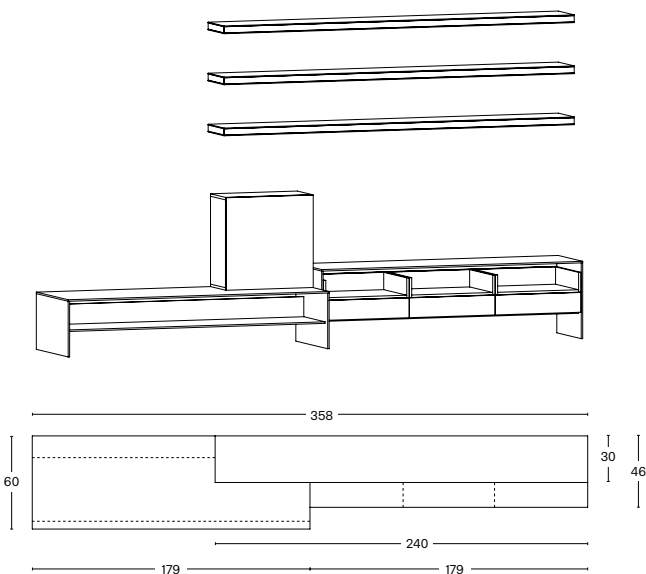

			□	■	■
3	M3	240x30xH5	980	1.080	1.090
1	P10	179x60xH37	1.600	1.650	1.660
1	P11	179x46xH50	1.540	1.590	1.600
3	CB1	59x45xH13	680		
3	EG1	59x45xH13	320		
1	EB1	60x30xH60	1.280		
TOTALE COMPOSIZIONE / TOTAL LAYOUT			10.360	10.760	10.810

- Vetro extrachiaro / extra clear glass / extrahelles Glas / verre extra clair
- Vetro fumé / smoked glass / Rauchglas / verre fumé
- Vetro bronzo / bronze glass / Bronze Glas / Verre bronze

	I E D F	dimensioni dimension abmessungen dimension	spessore thickness stärke épaisseur	volume volume volumen volume	carico ammesso admitted load tragfähigkeit charge admise	peso weight gewicht poids	prezzo price preis prix
		cm	mm	m3	kg	kg	euro

Whirl design Francesco Forcellini 2021	Ø 200 x 6	4	0,661			101	● 4.950
							●● 5.380
							●●● 5.440

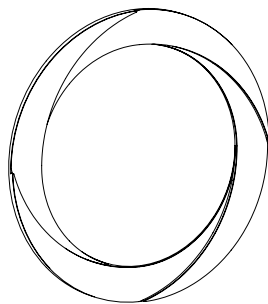

- Specchio / Mirror / Spiegel / Miroir
- Specchio fumè / Smoked mirror / Rauchglasspiegel / miroir fumé
- Specchio bronzo / Bronze mirror / Bronze Spiegel / Miroir bronze

- Specchio da parete con parte centrale rotonda e cornice esterna inclinata lavorata in rilievo. Disponibile in specchio, specchio fumè o bronzo. La struttura è sempre nera.
- Wall mirror with round central part and external inclined frame with embossed finish. Available in mirror, smoked mirror or bronze mirror. Structure is always black.
- Wandspiegel mit rundem Zentralteil und geneigtem Außenrahmen mit hervorgehobener Verarbeitung. Verfügbar in Spiegel, Rauchglasspiegel oder Bronze Spiegel. Struktur immer schwarz.
- Miroir au mur avec partie central ronde et corniche extérieur inclinée bossée en relief. Disponible en miroir, miroir fumé ou bronze. Structure toujours noir.

Zen design Gonzo - Vicari 1995	55 x 50 x h 50	15	0,28	35	45		1.130
--	----------------	----	------	----	----	--	-------

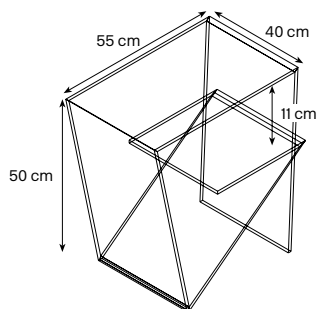

- Mobile multiuso o porta TV.
- Glass stand for TV or various uses.
- Glas-Kommode oder TV Ständer.
- Meuble à multiples emplois ou porte TV.

Tonellidesign

Tonelli Design

T.D. Srl

via Casali 40/42

61122 – Pesaro (PU) Italy

tel. +39 0721 481172

www.tonellidesign.it

info@tonellidesign.it

export@tonellidesign.it

-  [Tonelli design](#)
-  [Tonelli_Design](#)
-  [tonelli-design](#)
-  [Tonelli Design - Official](#)