

**Tonelli**design

**The New Modernism**

**Tonelli**design

---

# The New Modernism. Collection 2023

---

La nuova collezione Tonelli design esprime la connessione fra passato e presente interpretando un valore che consideriamo prezioso, da tutelare e proteggere. Il vetro ne è l'elemento conduttore, il fil rouge che mette tutto in collegamento con i suoi riflessi, con la sua trasparenza, con la sua luce.

Ambienti dove nuovi prodotti riescono a mettere in risalto la bellezza di tavoli, librerie e specchi già facenti parte della collezione, sempre attuali e moderni che superano il passare del tempo, lontani dagli stili formali e dai luoghi comuni.

La collezione 2023 esprime coerenza con quel progetto intrapreso da tempo, che porta Tonelli design ad interpretare a suo modo l'ambiente living, attraverso perfette combinazioni e relazioni con lo spazio domestico.

Un living che vogliamo rifletta il senso della realtà con elementi pratici ed eleganti, interpreti dei mutamenti degli stili di vita e di un nuovo vivere la casa, libero e personale.

The New Modernism è la nostra interpretazione del vivere e dell'arredare la casa, sempre in evoluzione, legato a quella cultura del design che caratterizza la storia del nostro marchio.

---

The Tonelli design new collection expresses the connection between past and present by interpreting a value that we consider precious, to be safeguarded and protected. Glass is the conductor element, the fil rouge that connects everything with its reflections, with its transparency, with its light.

Environments where new products are able to highlight the beauty of tables, bookcases and mirrors already included in our collection, always up-to-date and modern that stand the test of time, far from formal styles and clichés.

The 2023 collection expresses coherence with that project begun years ago, which leads Tonelli design to interpret the living environment in its own way, through perfect combinations and relationships with the domestic space.

A living ambience that we want to reflect the sense of reality with practical and elegant elements, interpreters of the changes in lifestyles and of a new way of living the home, free and personal.

The New Modernism is our interpretation of living and furnishing the home, increasingly defined and original, linked to the design culture that distinguishes the history of our brand.

---

# Scenery index Indice composizioni

---

## SC001

- 12 Scenery
- 14 WG system
- 22 Updown

---

## SC002

- 30 Scenery
- 32 T5
- 40 Vu
- 46 AW\_Chair

---

## SC003

- 56 Scenery
- 58 Soft Glass
- 64 Bakkarat basso
- 68 After9

---

## SC004

- 86 Scenery
- 88 Bakkarat alto
- 94 Beryl
- 100 Liber

---

## SC005

- 116 Scenery
- 118 Sestante
- 132 Gerundio

---

## SC006

- 142 Scenery
- 144 Livingstone
- 158 Maybe

---

## SC007

- 164 Scenery
- 166 Metropolis
- 172 Sestante\_stone

---

## SC008

- 184 Scenery
- 186 Hybrid
- 194 She

---

## SC009

- 212 Scenery
- 214 Thrim
- 226 Shoji cabinet

---

## SC010

- 234 Scenery
- 236 Metropolis XXL
- 244 Noum
- 252 Central

---

## SC011

- 260 Scenery
- 262 Perseo
- 270 Hyperion

---

## SC012

- 290 Scenery
- 292 Marcell

---

## SC013

- 302 Scenery
- 304 Crossover
- 314 Major

---

## SC014

- 324 Scenery
- 326 Hemingway
- 336 Whirl

---

# Type index Indice tipologico

---

## Tavoli alti Dining tables

- 32 T5 fused glass
- 36 T5
- 88 Bakkarat Alto
- 144 Livingstone
- 150 Livingstone Dark
- 168 Metropolis
- 166 Metropolis fused glass
- 186 Hybrid
- 218 Thrim
- 214 Thrim fused glass
- 236 Metropolis XXL
- 262 Perseo
- 304 Crossover

---

## Sedie Chairs

- 46 AW\_chair
- 194 She

---

## Divano Sofa

- 58 Soft Glass

---

## Tavoli bassi, fianchi divano Coffee tables, side tables

- 22 Updown
- 64 Bakkarat Basso
- 68 After9
- 78 After9 fused glass
- 100 Liber
- 128 Sestante
- 118 Sestante
- 172 Sestante\_stone

---

## Consolle, home office Console, home office

- 128 Sestante
- 172 Sestante\_stone
- 292 Marcell

---

## Madie Sideboards

- 226 Shoji Cabinet
- 314 Major

---

## Lampade Lamps

- 244 Noum
- 270 Hyperion

---

## Librerie Bookcases

- 100 Liber
- 326 Hemingway

---

## Sistemi living Living units

- 14 WG system

---

## Specchi Mirrors

- 40 Vu
- 94 Beryl
- 132 Gerundio
- 158 Maybe
- 252 Central
- 336 Whirl

---

# Alphabetical index

## Indice alfabetico

---

### A

- 68 After9
- 78 After9 fused glass
- 46 AW\_chair

---

### B

- 88 Bakkarat alto
- 64 Bakkarat basso
- 94 Beryl

---

### C

- 252 Central
- 304 Crossover

---

### G

- 132 Gerundio

---

### H

- 326 Hemingway
- 186 Hybrid
- 270 Hyperion

---

### L

- 100 Liber
- 144 Livingstone
- 150 Livingstone Dark

---

### M

- 314 Major
- 158 Maybe
- 292 Marcell
- 168 Metropolis
- 166 Metropolis fused glass
- 236 Metropolis XXL

---

### N

- 244 Noum

---

### P

- 262 Perseo

---

### S

- 128 Sestante
- 118 Sestante
- 172 Sestante\_stone
- 194 She
- 226 Shoji Cabinet
- 58 Soft Glass

---

### T

- 36 T5
- 32 T5 fused glass
- 218 Thrim
- 214 Thrim fused glass

---

### U

- 22 Updown

---

### V

- 40 Vu

---

### W

- 14 WG system
- 336 Whirl



---

# SC001

**Soft glass** Divano / Sofa  
Vetro extrachiaro, tessuto F 400  
Extra clear glass, fabric F 400

**WG system** Mensole / shelves  
Specchio / mirror

**Sestante** Tavolini / Coffee Tables  
Vetro extrachiaro, Extra clear glass

**Updown** Fianco divano / Side Table  
Vetro fuso verde, metallo champagne  
Fused glass green, metal champagne





---

**WG system**  
living units

design  
**Massimo Castagna**



Una nuova interpretazione del sistema giorno che fa della leggerezza del vetro la propria qualità principale. WG system può essere progettato nella massima libertà, con composizioni di moduli orizzontali disponibili in due altezze e due profondità. L'ampia scelta di contenitori prevede soluzioni ad anta battente, ante a ribalta, cassetti e vani a giorno.

A new interpretation of the living room system where the lightness of glass is the principal quality. WG system can be designed with maximum liberty, with compositions of horizontal elements available in two heights and two depths. The vast range of storage units includes solutions with hinge door, flap door, drawers and shelves.

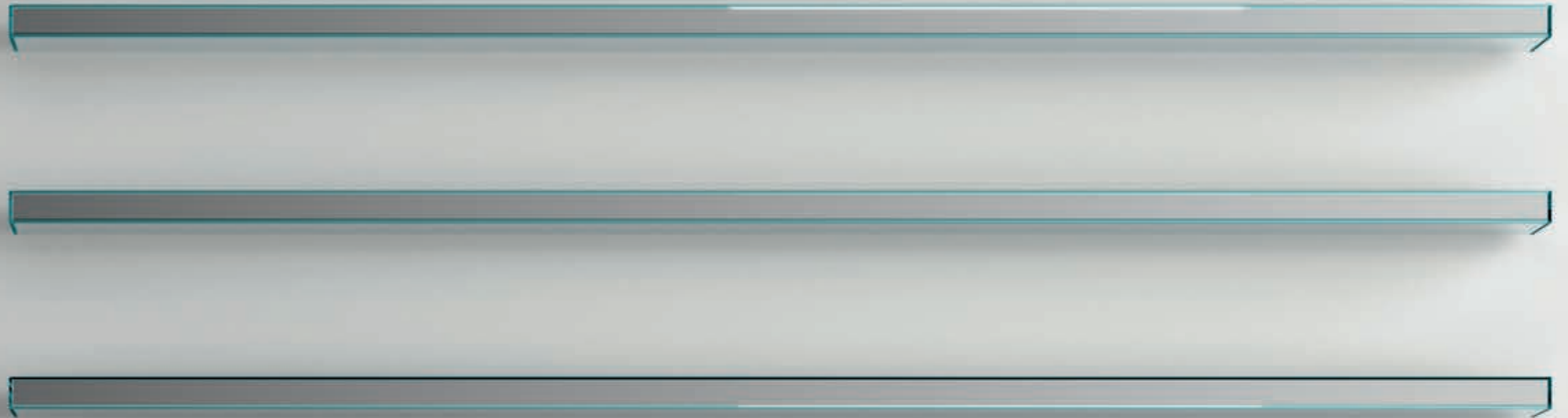

Mensole a parete con fissaggio a scomparsa, completamente rivestite in specchio. Le diverse larghezze disponibili permettono di aggiungere creatività alle composizioni.

Wall shelves with concealed fixing, completely covered with mirrors. The different lengths available allow to add creativity to the compositions.



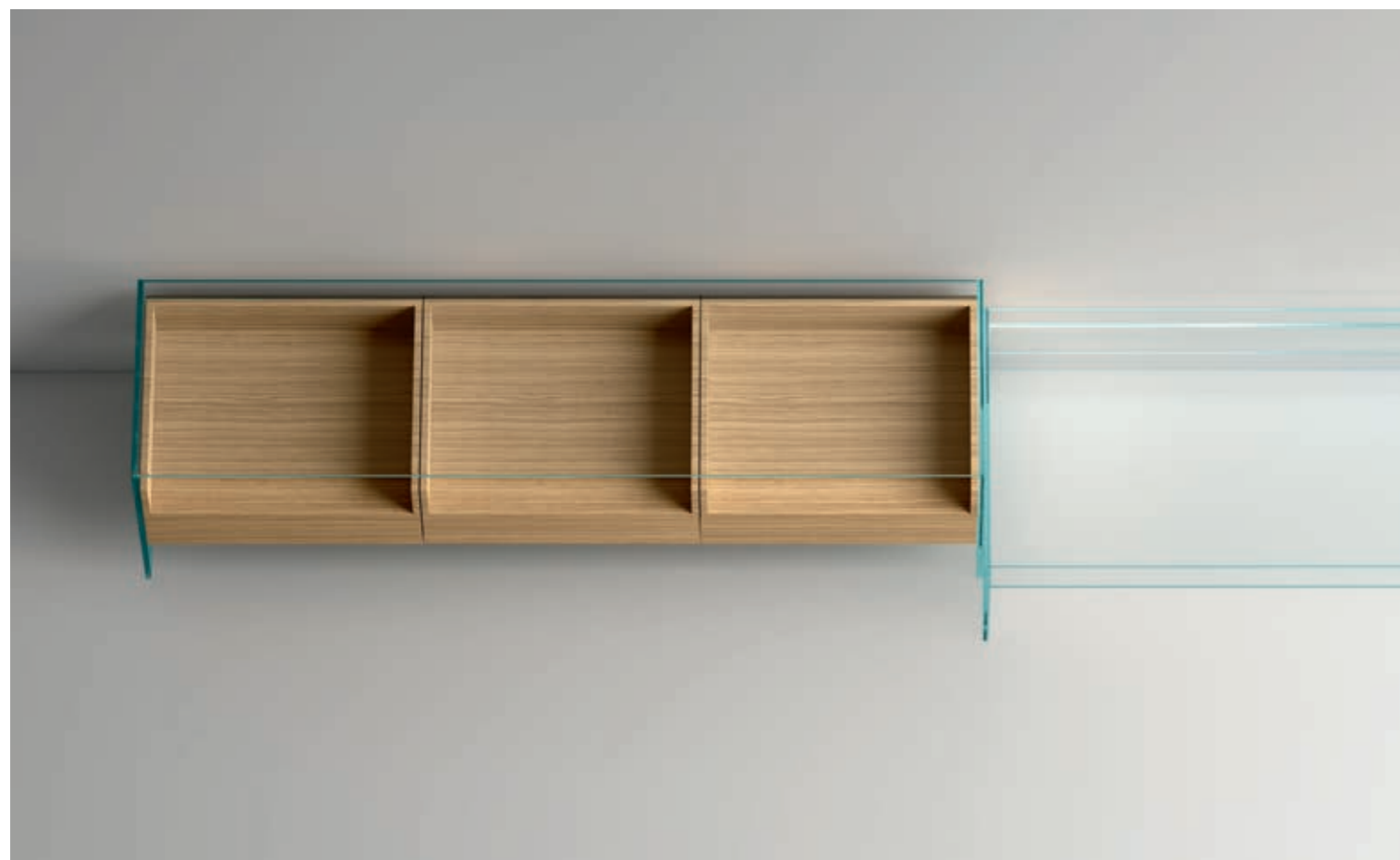

## WG system living units

design  
**Massimo Castagna**

### Info Tecniche / Technical Info

Sistema modulare di elementi in vetro saldato, con ripiano e schienale per alloggiare contenitori e optional in legno. Larghezze 61, 120 o 179cm, altezze 37 o 50cm, profondità 46 o 60cm, vetro extrachiaro, fumè o bronzo. Cassetti, contenitori a ribalta e vassoi a giorno accostabili da 60cm in legno Siberian Ash, Eucalipto o Rovere Naturale. Elemento in legno da appoggio con anta battente e ripiano interno in vetro. Completano la gamma elementi a ponte, ad uso base o piano di appoggio, in vetro saldato finiture extrachiaro, fumè o bronzo. Mensole a parete rivestite in specchio, specchio fumè e specchio bronzo nelle larghezze 120, 179 e 240cm.

Modular system of welded glass elements with shelf and back panel to fit in storage units and wooden optional elements. Widths 61, 120 or 179cm, heights 37 or 50cm, depths 46 or 60cm, extra clear, smoked or bronze glass. Drawers, flap door storage units and open trays size 60cm in Siberian Ash, Eucalipto or Natural Oak. Sit-on wooden element with hinge door and internal glass shelf. Completing the range, the bridge-like elements, to be used as base or countertop, in glued extra clear, smoked or bronze glass. Wall shelves with mirror covering in clear mirror, smoked or bronze mirror in 120, 179 or 240cm width.

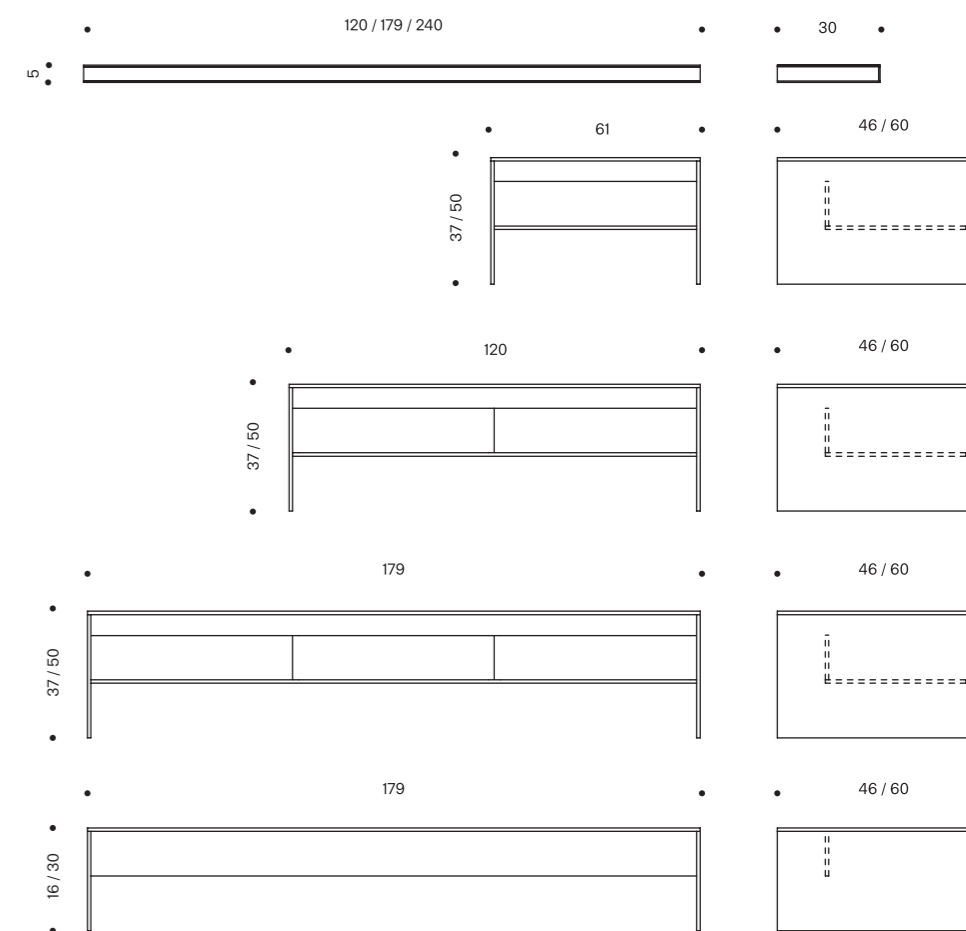

---

## Updown side tables

design  
**Martina Castagna**

Collezione di fianchi divano dalla elegante ed originale struttura in metallo. Sono disponibili diverse dimensioni e altezze, con piani e basi di forma rotonda o quadrata realizzabili in vetro fuso o metallo. La loro varietà estetica li colloca, da soli o raggruppati, in diversi ambienti della casa.

Collection of side tables with elegant and original metal frame. Several dimensions and heights are available with tops and bases in round or square shape that can be made of fused glass or metal. The aesthetic variety allows to place them, on their own or in groups, in several environments of the house.



Le forme primitive di base e top esaltano il dettaglio dello stelo centrale in metallo, accuratamente tornito nello spessore e rifinito in superficie.

The primitive shapes of base and top enhance the central stem's metal detail, meticulously turned in its thickness and refined on the surface.





## Updown side tables

design  
**Martina Castagna**

### Info Tecniche / Technical Info

Tavolini a stelo centrale con base e top quadrati o rotondi. Top in vetro fuso fumè, bronzo e tre tonalità di verde semitrasparente o in metallo con profilo sagomato in finitura champagne. Basi in vetro fuso fumè, bronzo e laccato in tre tonalità di verde o in metallo con profilo sagomato in finitura champagne. Lo stelo centrale è disponibile in tre diverse altezze e in finitura champagne.

Small table with central stem and square or round base and top. Top in fused glass smoked, bronze and three shades of semi-transparent green or in metal with shaped profile in champagne finish. Glass bases in fused glass smoked, bronze and three shades of green or in metal with shaped profile in champagne finish. The central stem is available in three different heights and in champagne finish.

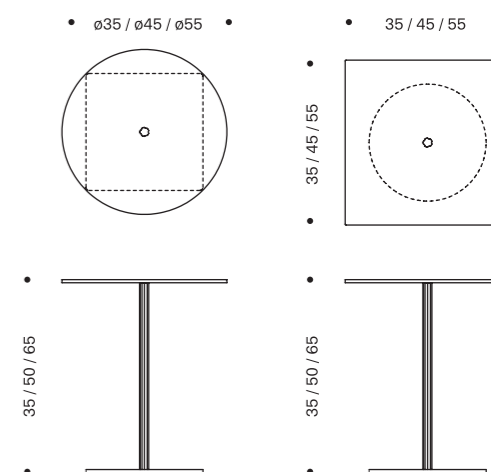

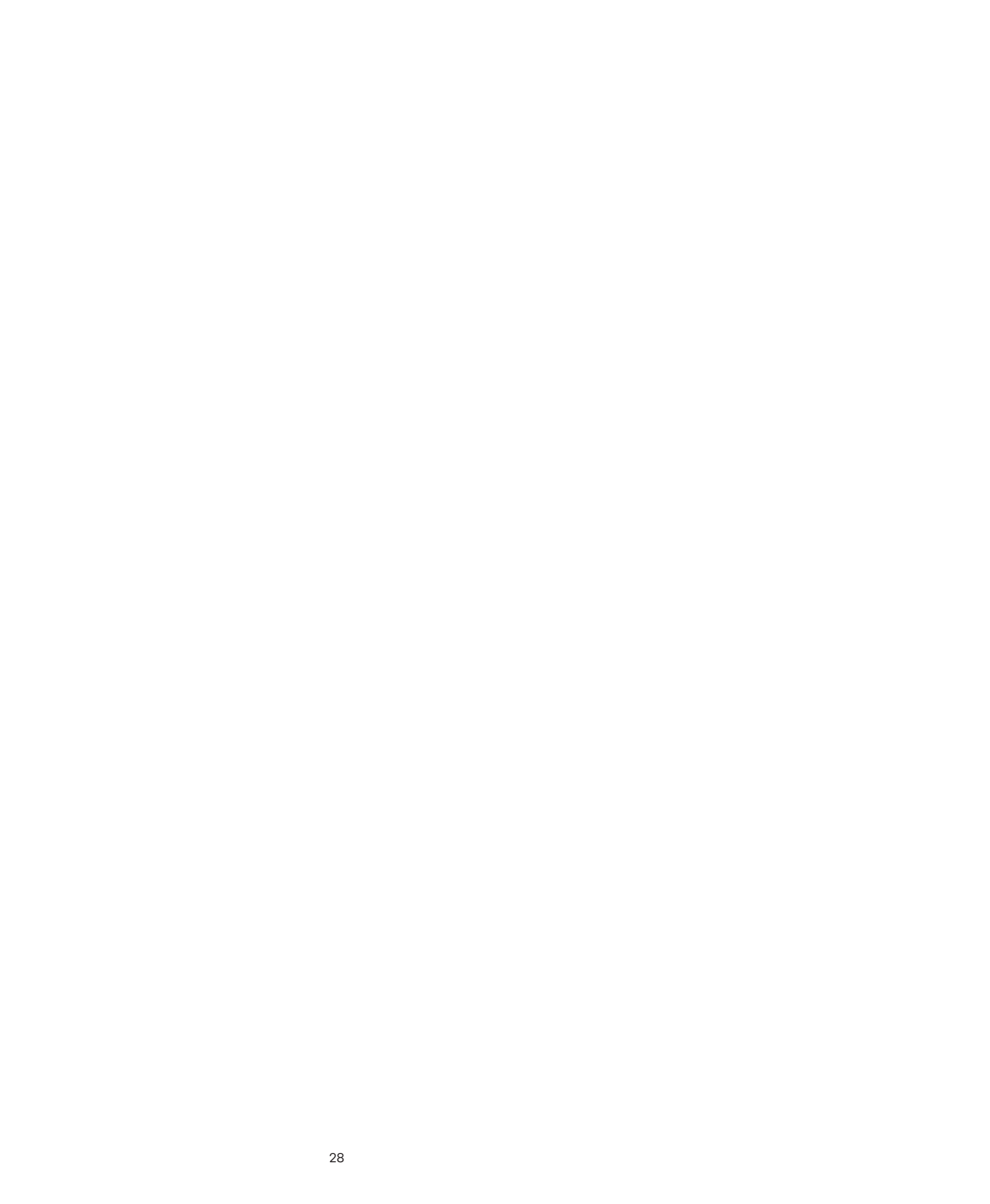



---

## SC002

**T5 fused glass** Tavolo / Table  
Vetro bronzo fuso, metallo champagne  
Fused bronze glass, metal champagne

**AW\_chair** Sedia / Chair  
Siberian ash, tessuto P 304  
Siberian ash, fabric P 304

**Hyperion** Lampada / lamp  
Cromo lucido, vetro pyrex soffiato trasparente  
Polished chrome, transparent blown pyrex glass

**VU** Specchio / Mirror

**Major** madia / sideboard  
Eucalipto, vetro bronzo  
Eucalipto, bronze glass



---

**T5 fused glass**  
dining tables

design  
**Giulio Mancini**



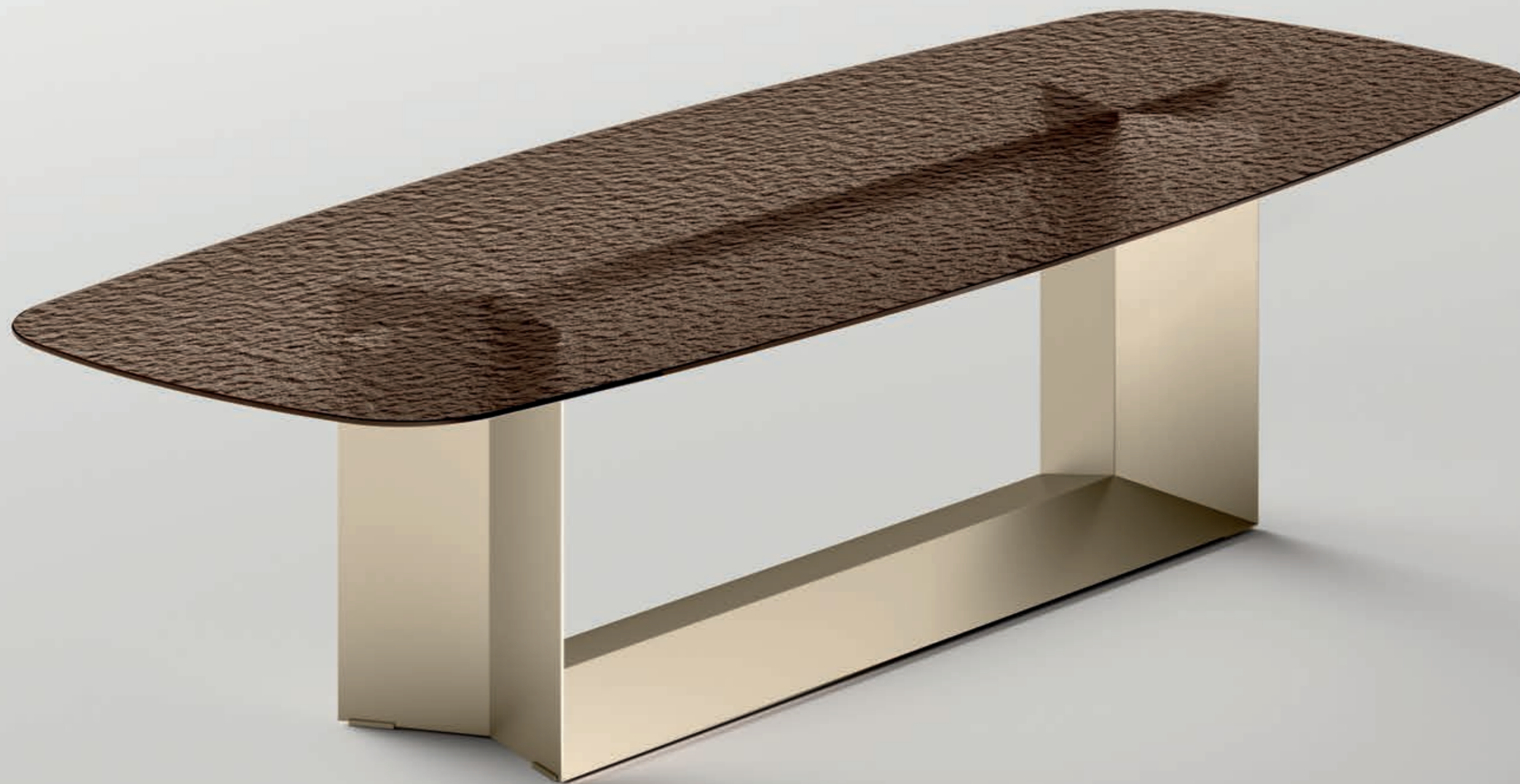

Essenziale e ricercato, T5 fused glass è il tavolo da pranzo disponibile con il top in vetro fuso. Attraverso una innovativa lavorazione artigianale la lastra di vetro viene portata ad alta temperatura donando al vetro un effetto di irregolare morbidezza.

Essential and refined, T5 fused glass is the dining table available with fused glass top. Through an innovative craftsmanship the glass sheet is treated with high temperature conferring the glass an effect of irregular softness.

---

## T5 dining tables

design  
**Giulio Mancini**

Il tavolo T5, assoluto protagonista della zona dining, ha il basamento centrale rifinito con verniciature opache o spazzolate. L'esclusiva varietà delle finiture previste consente una naturale combinazione con le proposte della collezione Tonelli design.

The T5 table, absolute star of the dining area, has a central base refined with matt or brushed lacquering. The exclusive variety of finishings provides a natural combination with the proposals of the Tonelli design collection.

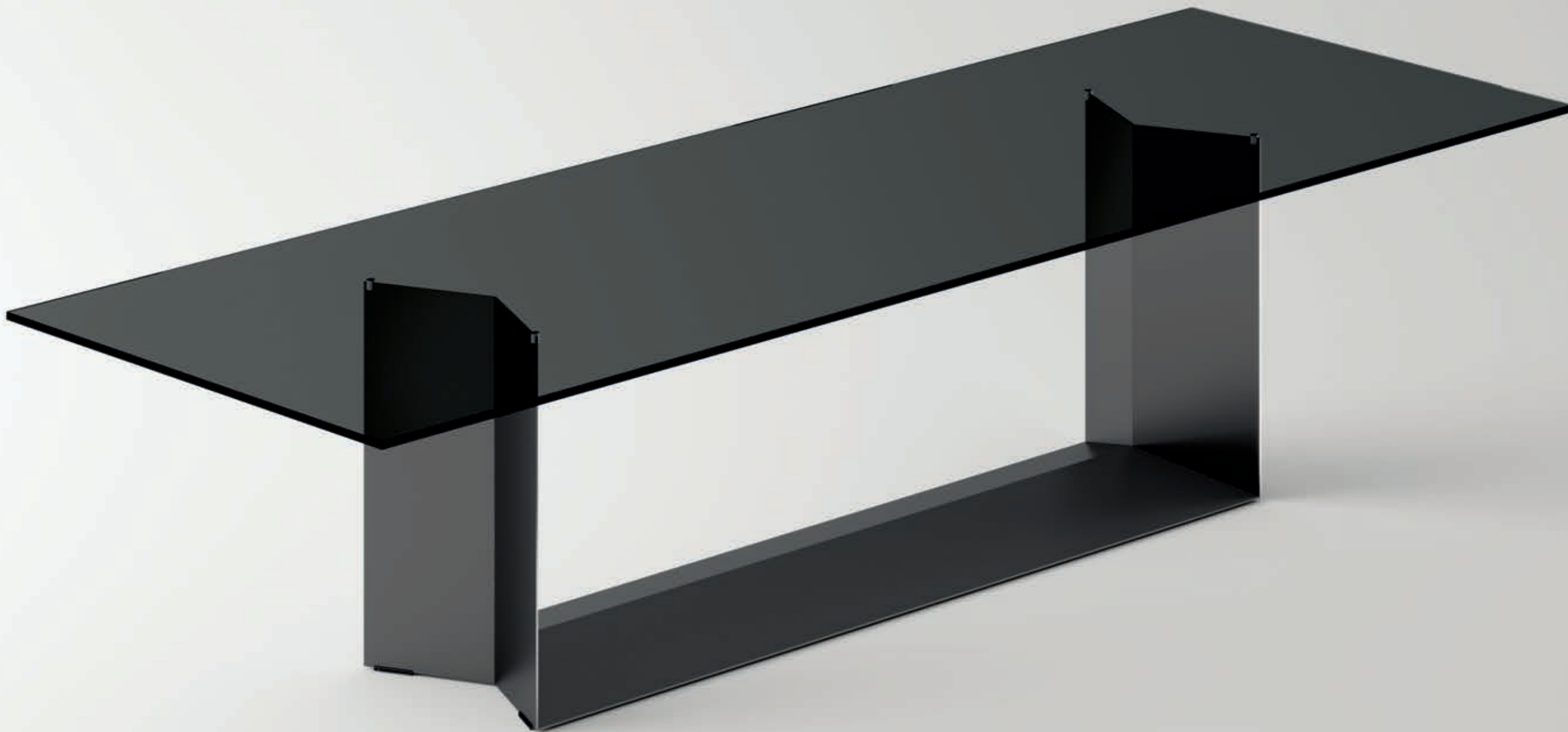



## T5 fused glass / T5 dining tables

design  
**Giulio Mancini**

### Info Tecniche / Technical Info

Tavolo con basamento centrale. Struttura in metallo nelle finiture nero grafite, bianco opaco, bronzo o Titanio spazzolato o champagne. Top in vetro fuso fumè o bronzo e in vetro extrachiaro o fumè temperato in appoggio su basamento. I tops sono disponibili nelle forme rettangolari e rettangolari sagomate.

Table with central base. Metal structure in black graphite, matt white, brushed bronze and Titanio or champagne finish. Glass top in smoked or bronze fused glass and extra clear or smoked tempered glass, resting on the base. The table top is available in rectangular or shaped rectangular version.

**Piano vetro fuso**  
**Fused glass Top**  
200x110  
220x110  
240x110  
260x110  
280x110  
300x110  
320x120

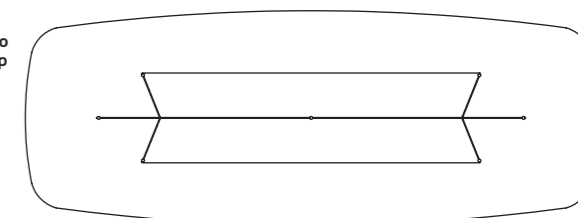

**Piano / Top**  
200x100  
225x90  
240x100  
245x120  
260x100  
280x100  
300x100

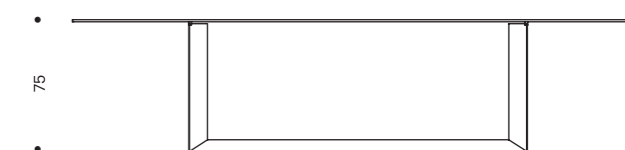

---

**VU**  
mirror

design  
**Giovanni Tommaso Garattoni**

Più che uno specchio, è un oggetto di grande valore artistico, un elemento decorativo di notevole impatto e presenza. Una texture tridimensionale ottenuta per affiancamento di diversi spessori di lastre di vetro.

More than a mirror it is an object of great artistic value, a decorative element of remarkable impact and presence. A three-dimensional texture obtained by placing side by side different glass thicknesses.





Ogni elemento è utilizzabile singolarmente o accostato per creare composizioni custom adattabili ad ogni esigenza di progetto.

Each element can be used individually or combined to create custom compositions adaptable to any project.



## VU mirror

design  
**Giovanni Tommaso Garattoni**

### INFO TECNICHE / TECHNICAL INFO

Specchio modulare a parete, realizzato con lastre di vetro extrachiaro di diverso spessore accostate e saldate tra loro su un fondo a specchio. Su richiesta si possono realizzare altezze e larghezze a misura.

Modular wall mirror made of glass panels in extra clear glass of different thicknesses, put side by side and glued together on a back panel in mirror. Custom height and width available.

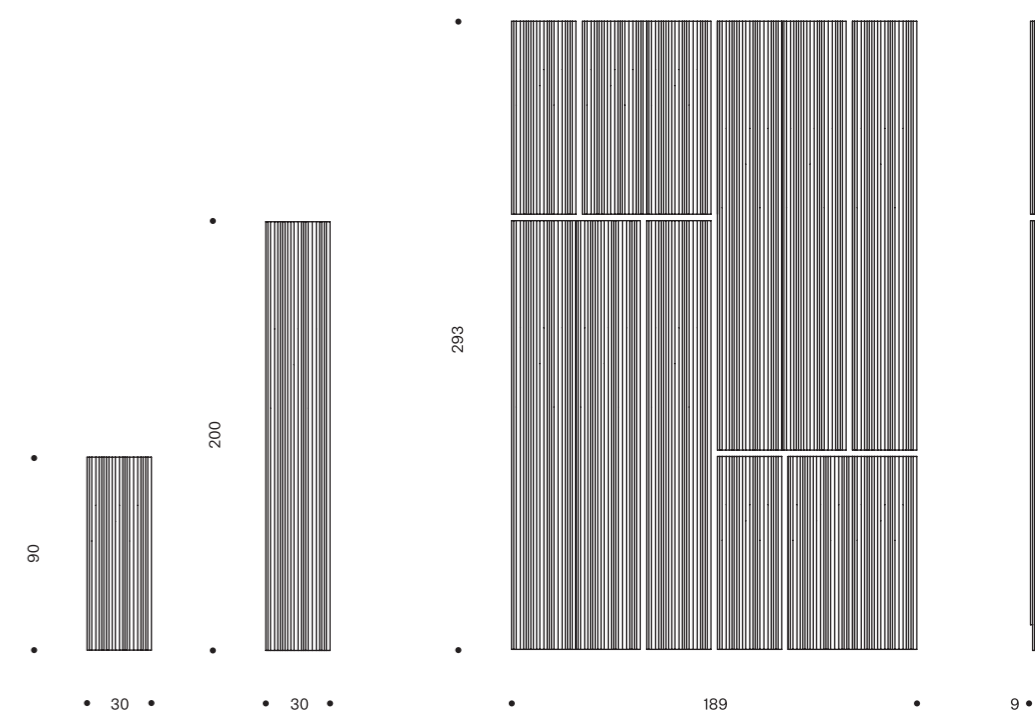



---

**AW\_Chair**  
chair

design  
**Massimo Castagna**





Pratica e versatile la sedia AW\_chair, in legno massello, è la combinazione di minuziose lavorazioni manuali e l'uso di macchine di ultima generazione. La cura dei dettagli, dal particolare in metallo sullo schienale alla speciale forma delle gambe, fino alle combinazioni con esclusivi tessuti, la rende una sedia raffinata e di carattere.

Practical and versatile the AW\_chair in solid wood, is the combination of meticulous handwork and the utilization of next-generation machinery. The attention to detail, from the metal element on the backrest to the special form of the legs and the combination with exclusive fabrics, make it a refined and characterful chair.





## AW\_Chair chair

design  
**Massimo Castagna**

### Info Tecniche / Technical Info

Sedia in legno massello di frassino con gambe tor-nite e struttura a traversi incrociati. Disponibile nelle finiture Siberian Ash, Eucalipto, Rovere Naturale e laccato nero a poro aperto. Seduta sagomata e imbottita, rivestita in tessuto. Schienale in legno curvato imbottito e rivestito in tessuto frontalmen-te, chiuso da una cucitura a cordone sul bordo per lasciare il legno a vista sul retro. Giunto di unione fra schienale e struttura in metallo lucidato.

Chair in solid ashwood with turned legs and struc-ture with crossbars. Available in Siberian Ash, Euca-lipto, Natural Oak and open grain black lacquered. Shaped and upholstered seat, covered with fabric. Backrest in curved wood upholstered and cove-red frontally with fabric, finished with a cordon stitching on the edge to leave the wood in the back visible. Junction between backrest and structure in polished metal.

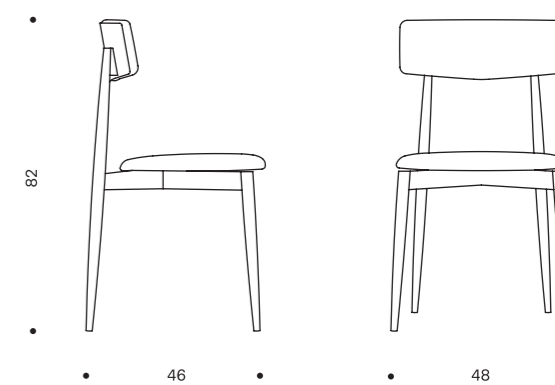



# SC003

**Soft Glass** Divano / Sofa  
Vetro extrachiaro, tessuto P 802 - F 400  
Extra clear glass, fabric P 802 - F 400

**Gerundio** Specchio / Mirror

**After9** Tavolini / Coffee Tables  
Marmo Bianco Carrara, canna di fucile lucido, inox lucido. Vetro extra chiaro, canna di fucile lucido, inox lucido. Vetro fumè, canna di fucile lucido, inox lucido. Bianco Carrara marble, polished gunmetal, polished stainless steel. Extra clear glass, polished gunmetal, polished stainless steel. Smoked glass, polished gunmetal, polished stainless steel.

**Bakkarat** Tavolino / Side Table  
Vetro extrachiaro, cromo lucido  
Extra clear glass, polished chrome

**Hemingway** Libreria / Bookcase  
Siberian Ash, inserti cromo lucido, vetro fumè  
Siberian Ash, polished chrome inserts, smoked glass



---

**Soft Glass**  
sofa

design  
**Massimo Castagna**





Composto da volumi morbidi e generosamente imbottiti, il sistema di sedute Soft Glass introduce un nuovo modo di progettare lo spazio living, con moduli che consentono composizioni originali, più dinamiche e informali. Sia nelle configurazioni più importanti che in quelle contenute, il divano conserva una sua leggerezza visiva grazie alla base che è sempre costituita da piedi in vetro stratificato a supporto di un pianale in legno sul quale poggiano gli elementi imbottiti. Tessuti ricercati di alta qualità e raffinati dettagli nella confezione costituiscono i tratti distintivi di un progetto dal carattere non convenzionale.

Made of soft volumes and generously upholstered, the seating system Soft Glass introduces a new way to design the living area, with modules that give life to original compositions, more dynamic and informal. Both in the more relevant or more restrained configurations the sofa retains a visual lightness because of the base that is always made of stratified glass supporting a wooden platform on which rest the upholstered elements. Sophisticated fabrics of high quality and refined manufacturing details are the main traits of this project of unconventional character.





## Soft Glass sofa

design  
**Massimo Castagna**

### Info Tecniche / Technical Info

Divano con struttura portante in legno listellare su basi in vetro stratificato e saldato spessore 20mm, finitura extrachiaro, fumè e bronzo. Sedute, schienali e braccioli imbottiti in poliuretano espanso a densità variabile rivestito con tessuto protettivo. Rivestimento esterno in tessuto sfoderabile con cucitura doppia a vista. La varietà di elementi preconfigurati accostati consente di elaborare un elevato numero di composizioni.

Sofa with supporting structure made of blockboard on stratified glass of 20mm, finish extra clear, smoked or bronze. Seatings, backrests and armrests in polyurethane foam with varying density covered with protective fabric. External lining in removable fabric with visible double stitching. The variety of juxtaposed preconfigured elements allows to develop a large number of compositions.

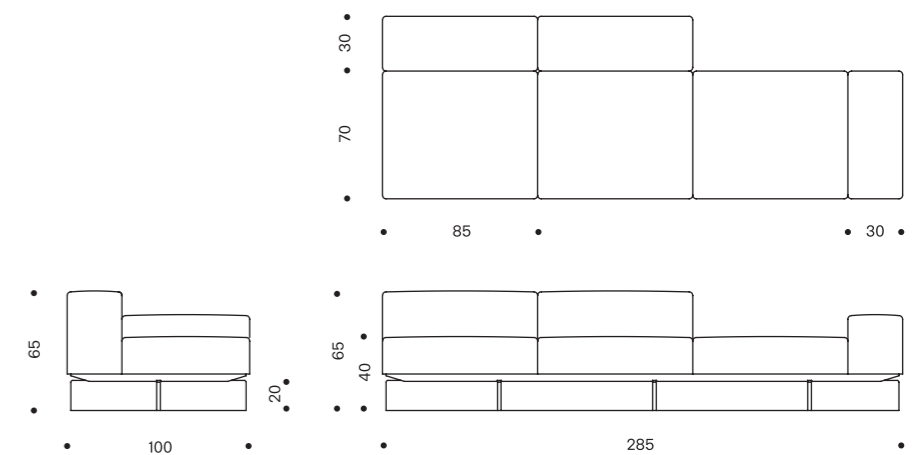

---

## Bakkarat basso side tables

design  
D'Urbino Lomazzi

I tavolini e i fianchi divano Bakkarat sono caratterizzati da una gamba in vetro di forte spessore con molature a diamante e da una base in specchio che ne amplifica la luminosità. Con il loro design essenziale, si adattano con estrema versatilità alle esigenze domestiche, dall'area living alla zona notte.

The side tables Bakkarat are made of a thick glass leg with diamond shaping and a mirrored base that amplifies its brightness. With their essential design they adapt with extreme versatility to any domestic need, from the living to the sleeping area.





## Bakkarat basso side tables

design  
D'Urbino Lomazzi

### Info Tecniche / Technical Info

Tavolino o fianco divano in vetro extra chiaro. Top saldato su gamba in vetro di forte spessore, base in metallo rivestita specchio. Disponibile in due altezze e due diametri per il top.

Small table or side table in extra clear glass. Top welded to the glass leg of high thickness, base in metal covered by mirror. Available in two heights and two diameters for the top.

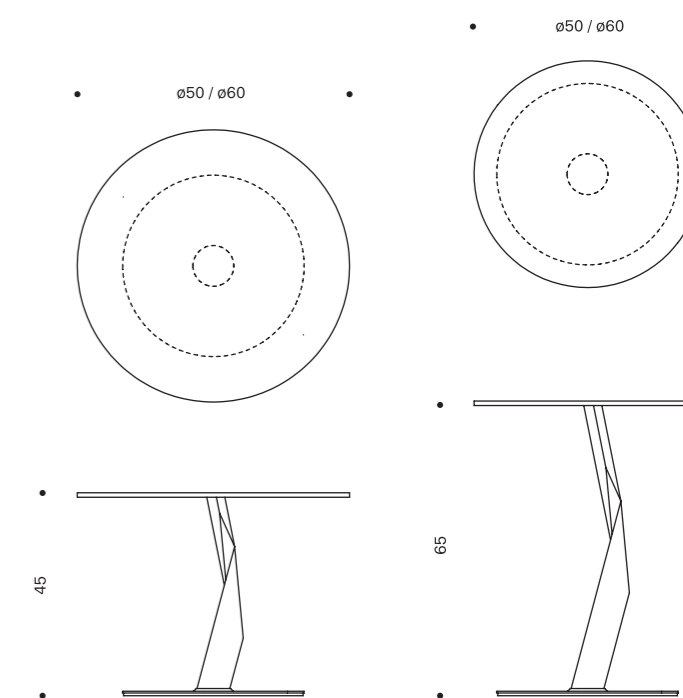

---

**After9**  
side / low tables

design  
**Massimo Castagna**



Collezione di tavoli bassi e fianchi divano, dalla minimale struttura in metallo con finiture in contrasto. Sono disponibili diverse dimensioni e altezze, con piani di forma organica realizzabili in vetro, vetro fuso, legno e marmo. L'ampia gamma di finiture e forme consente accostamenti ed aggregazioni dinamiche e originali.

Collection of low tables and side tables, with minimalistic metal structure and contrasting finishes. Available in several dimensions and heights, with organic shaped tops made of glass, fused glass, wood and marble. The vast range of finishes and shapes allows for dynamic and original combinations.



Il supporto superiore in metallo, sempre in acciaio inox lucido, dialoga con le diverse finiture del telaio inferiore, dando vita a insolite composizioni.

The upper metal support, always in stainless steel, communicates with the different finishes of the lower frame, creating unusual compositions.



I piani in marmo e legno sono alleggeriti ed impreziositi da una esclusiva lavorazione di bisellatura del bordo, che crea armonia tra i materiali e le forme.

The marble and wood tops are embellished by an exclusive bevelling of the edges, creating harmony between the materials and forms.







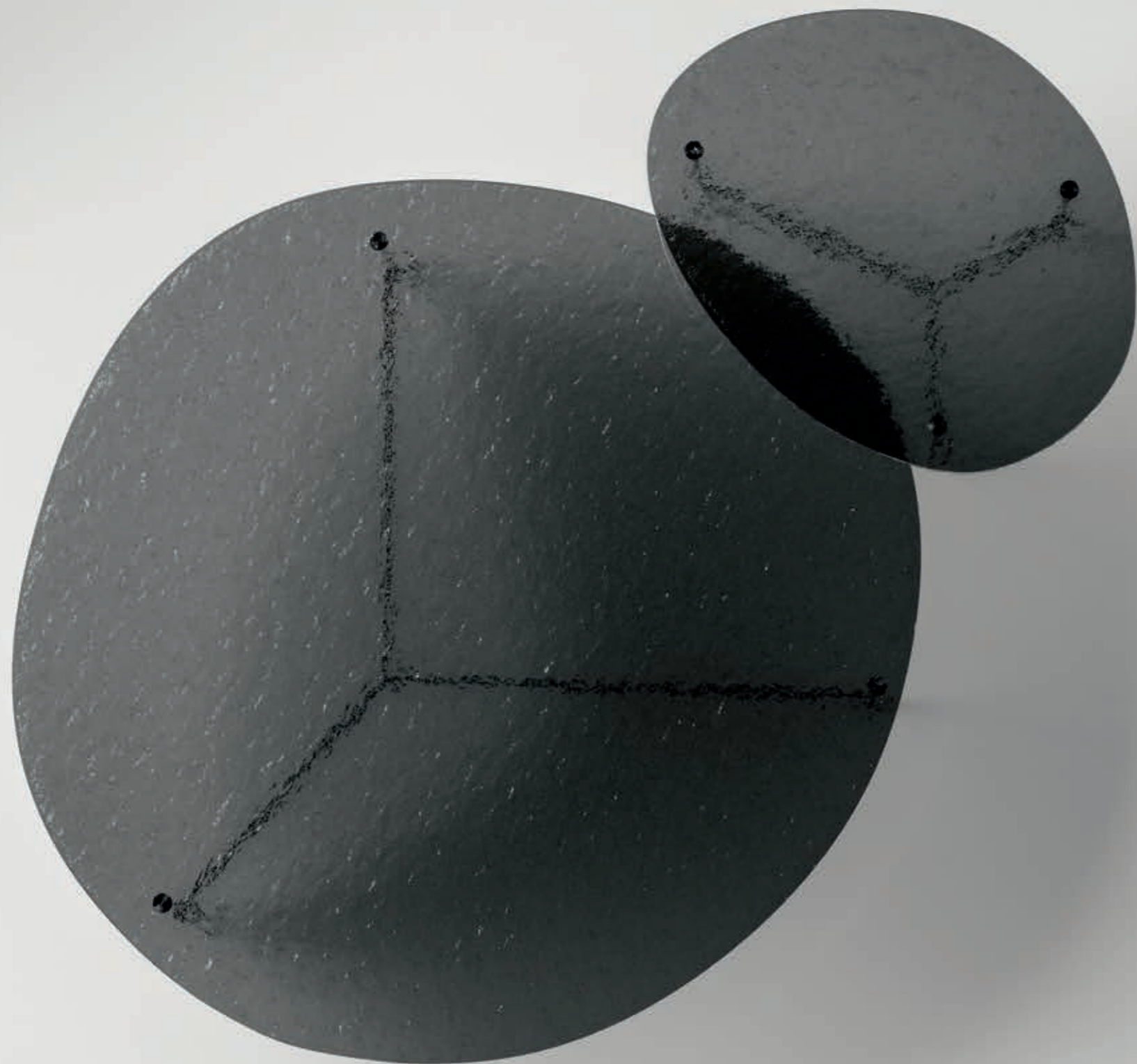

---

**After9**  
**fused glass**  
side / low tables

design  
**Massimo Castagna**

Oltre alle finiture top già disponibili si aggiungono quelle nuove in vetro fuso che, con il loro aspetto materico di irregolare morbidezza, rendono la collezione ancora più dinamica e in linea con le necessità d'uso della modernità.

To the already available top finishes are now being added those in the new fused glass, whose material aspect of irregular softness make the collection even more dynamic and aligned to modern needs.





**After9**  
**After9 fused glass**  
 side / low table  
 design  
**Massimo Castagna**

**INFO TECNICHE / TECHNICAL INFO**

Collezione di tavoli bassi e fianchi divano con struttura in metallo. Supporto superiore in acciaio inox lucidato, telaio e supporto inferiore, disponibili nelle finiture cromo, oro, rame, canna di fucile, lucide o spazzolate. Top in vetro extra chiaro, fumé o bronzo, vetro fuso fumé o bronzo, legno Siberian Ash o Eucalipto, marmo spazzolato Arabescato Orobico Gold, Tropikal Storm o Domus White, marmo spazzolato e Lucido Nero Marquinia, Bianco Carrara o Sahara Noir.

Collection of low tables and side tables with metal structure. Upper support in stainless steel, frame and lower support available in chrome, gold, copper, gunmetal, polished or brushed. Top in glass extra clear, smoked or bronze, fused glass smoked or bronze, in wood Siberian Ash or Eucalipto, brushed marble Arabescato Orobico Gold, Tropikal Storm or Domus White, brushed and polished marble Nero Marquinia, Bianco Carrara or Sahara Noir.

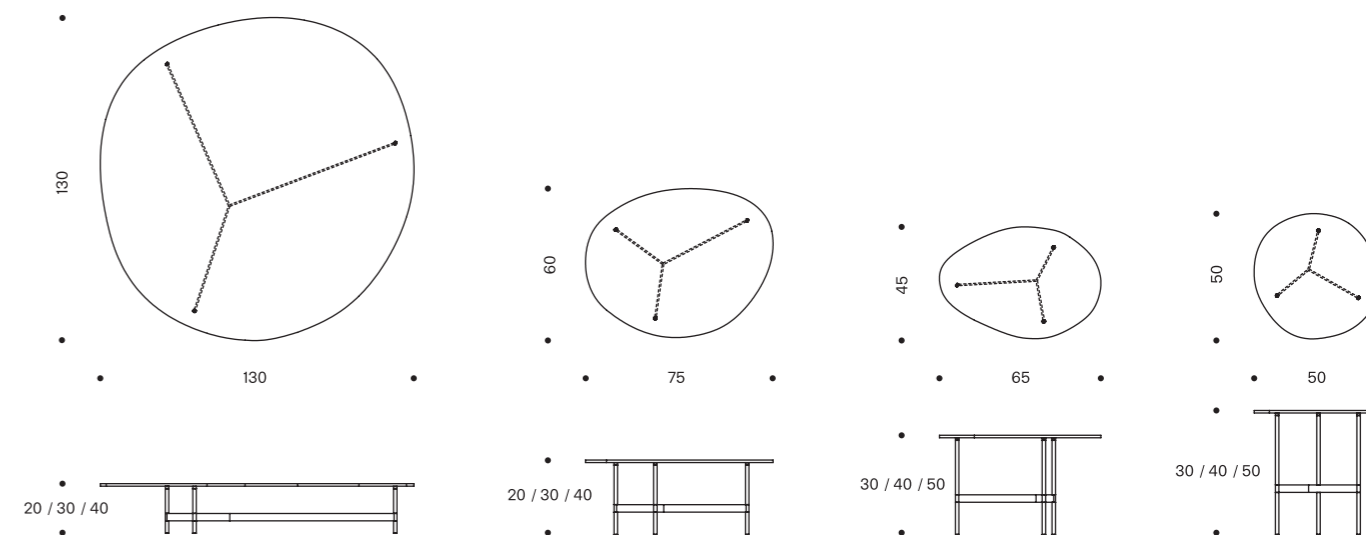



---

## SC004

**Bakkarat alto** Tavolo / Table  
Vetro extrachiaro, cromo lucido  
Extra clear glass, polished chrome

**She** Sedia / Chair  
Canna di fucile lucido, ecopelle 1005  
Polished gunmetal, faux leather 1005

**Noum** Lampada / Lamp  
Rovere naturale, natural oak

**Liber** Libreria / Bookcase  
Vetro extrachiaro / extra clear glass

**Beryl** Specchio / Mirror



---

## Bakkarat alto dining tables

design  
D'Urbino Lomazzi

La gamba in vetro di forte spessore con molature a diamante costituisce la parte essenziale di questo iconico tavolo con top in vetro, dove l'eleganza raffinata della base diventa protagonista attraverso la trasparenza del piano.

The thick glass leg with diamond shaping makes up the essential part of this iconic table with glass top, where the refined elegance of the base becomes the starring element through the transparency of the top.







## Bakkarat alto dining tables

design  
**D'Urbino Lomazzi**

### Info Tecniche / Technical Info

Tavolo rotondo in vetro extra chiaro. Gamba centrale in vetro di forte spessore saldato su piastre in acciaio inox. Base con piedini regolabili e smontabile, in metallo cromo lucido.

Round table in extra clear glass. Central leg made of extra thick glass glued to a stainless-steel plate. Base in polished chrome metal with small adjustable and removable feet.

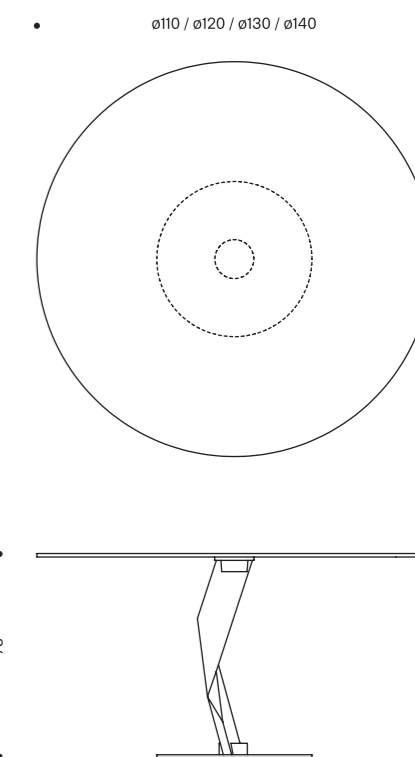



---

**Beryl**  
mirror

design  
Francesco Forcellini





Beryl è una pietra preziosa fuori scala, uno specchio scultura. Le sfaccettature laterali creano una sensazione di solidità alleggerita dalle curvature del profilo e parlano un linguaggio visivo proprio. Giustappponendo piani inclinati con linee curve, crea un oggetto pulito ma sofisticato che colpisce al primo sguardo.

Beryl is an out-of-scale gemstone, a mirror sculpture. The side facets create a sense of solidity, alleviated by the profile's curving, and have their own visual language. The alternation of inclined surfaces with curved lines gives life to a clean but sophisticated object that immediately catches the eye.



## Beryl mirror

design  
**Francesco Forcellini**

### Info Tecniche / Technical Info

Specchio da parete con struttura in legno verniciata nero. E' disponibile in specchio, specchio fumè e bronzo, nelle forme verticali e orizzontali.

Wall mirror with black lacquered wooden structure. Available in mirror, smoked and bronze mirror, vertical or horizontal.

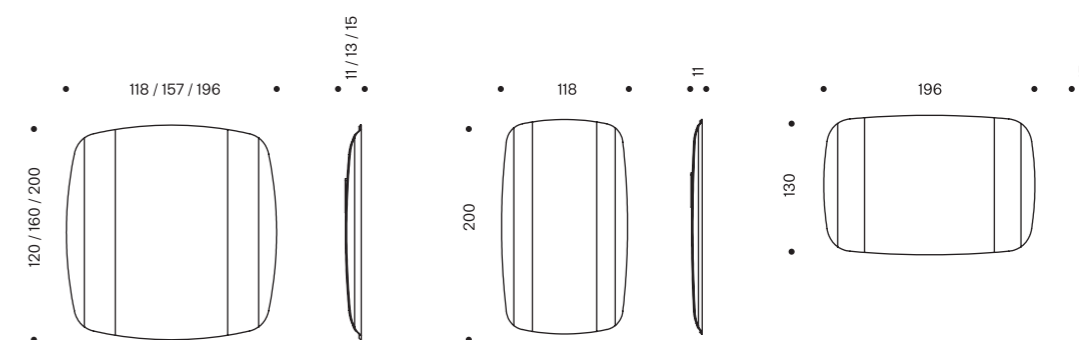

---

**Liber**  
bookcase  
side tables

design  
Luca Papini

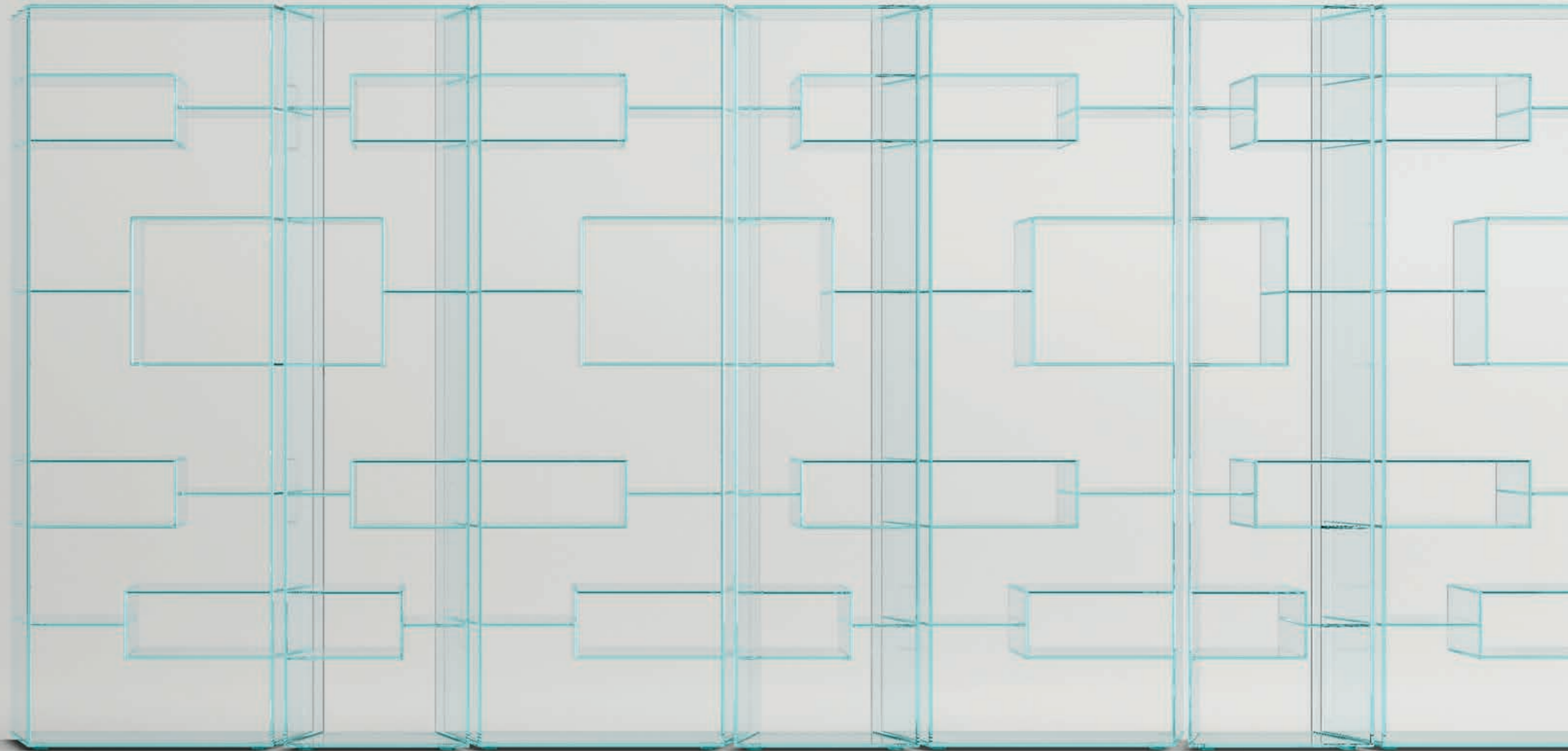

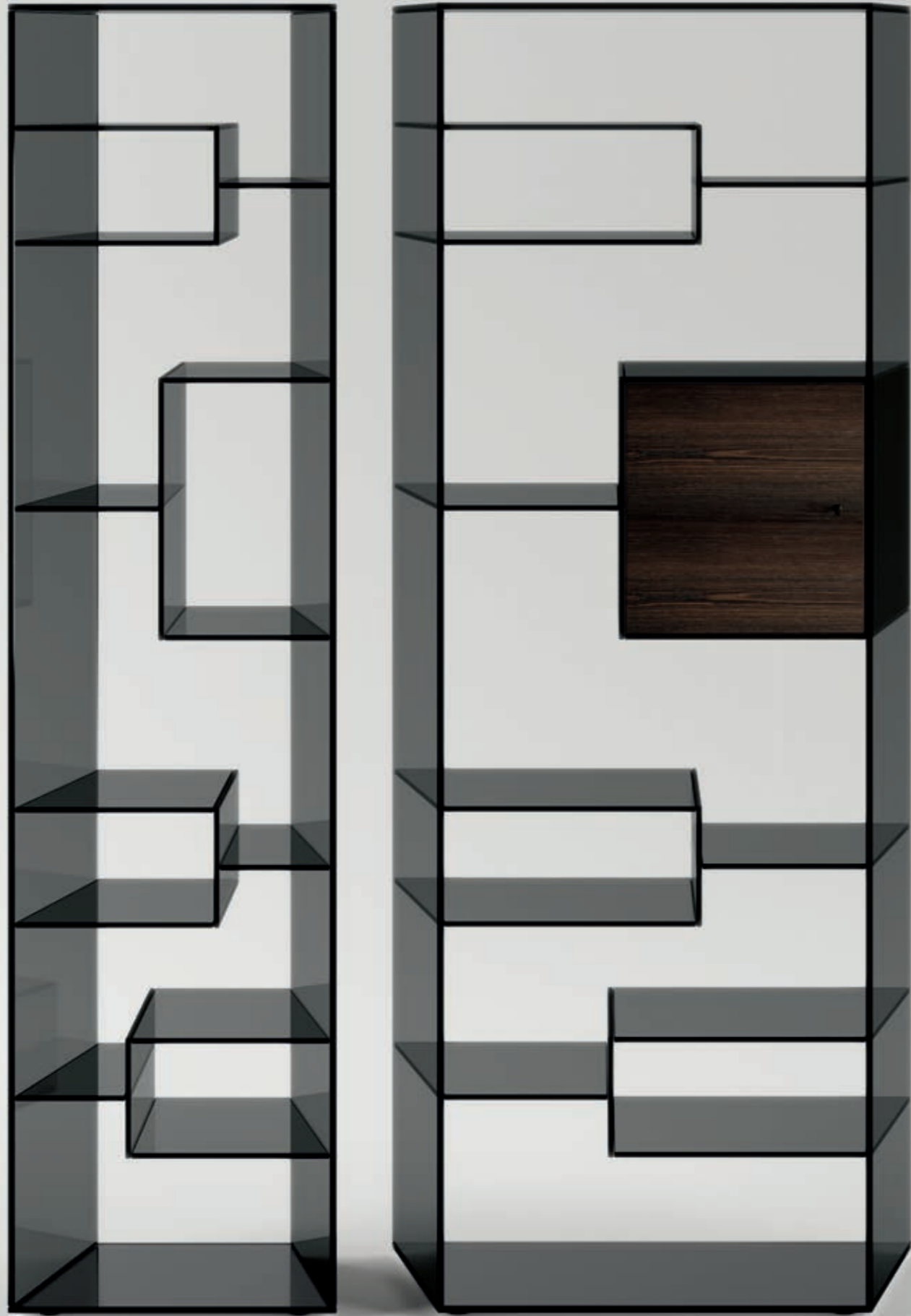

La collezione Liber comprende moduli a fianchi inclinati che permettono di realizzare composizioni curvilinee o lineari. Le nuove dimensioni, in altezza e larghezza, rendono la libreria il prodotto ideale per dividere gli ambienti e valorizzare gli spazi. Il nuovo contenitore in legno con anta battente la impreziosisce e ne aumenta le possibilità di utilizzo.

The Liber collection includes modules with inclined sides that can be used for curvilinear or linear compositions. The new dimensions, in height and width, make this bookcase the ideal product to use as room divider and enhance the spaces. The new wooden storage unit with hinge door enhances it and increases the possibilities of its utilisation.

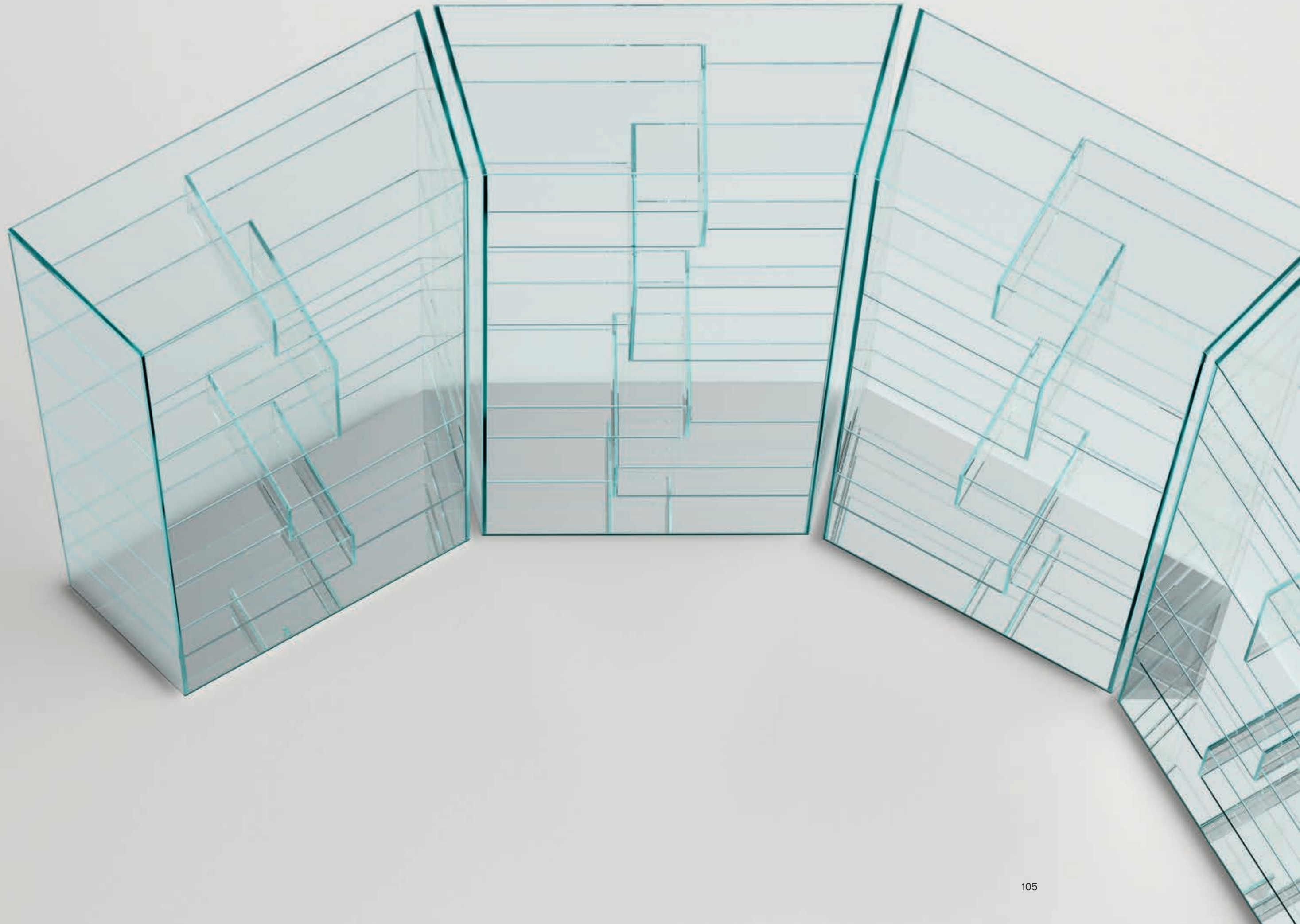

Espositore o libreria freestanding Liber, nella versione con i fianchi dritti, è attrezzabile con contenitori pratici e di design. Si spazia dall'essenza ai laccati alla finitura in cuoio testa di moro con cuciture in contrasto per poter arredare qualsiasi ambiente assecondandone lo stile.

Freestanding display or bookcase Liber, in the version with straight sides, can be equipped with practical designer drawers. The range goes from wood to lacquered finishes to dark leather with contrasting stitching so as to decorate any environment accommodating the existing style.

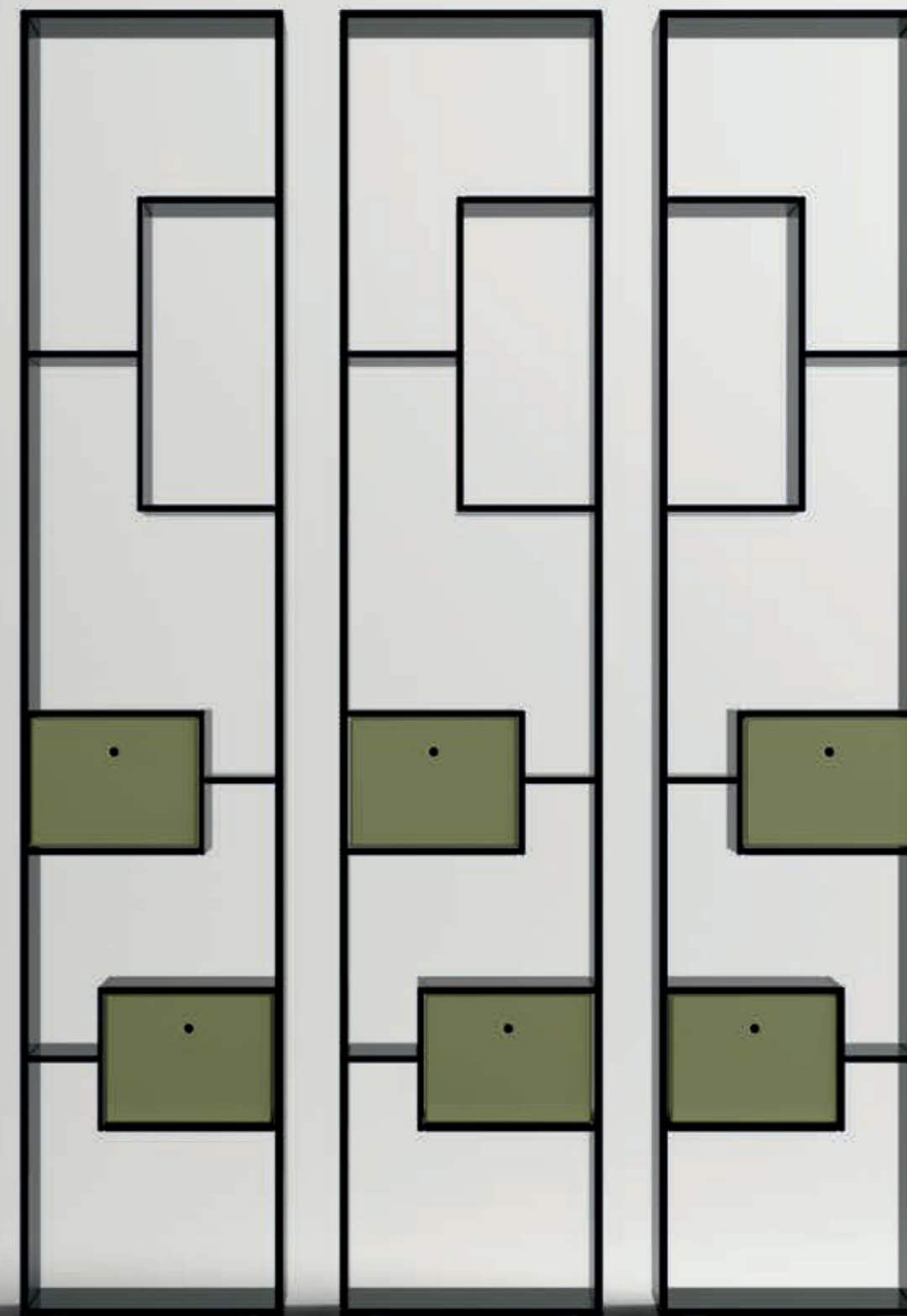





Le versioni fianco divano e comodino completano la zona living e la zona notte. I cassetti optional aggiungono praticità e permettono un'ampia personalizzazione.

The side table and bed side table version complete the living area and bedroom. The optional drawers add practicality and allow for ample personalization.





## Liber bookcase side tables

design  
Luca Papini

### INFO TECNICHE / TECHNICAL INFO

Libreria o espositore in vetro trasparente, extra chiaro o fumè con base a specchio e piedini regolabili. Disponibile in due altezze e due larghezze e nelle versioni destra e sinistra per diverse proposte compositive. Contenitore in legno in Siberian Ash o Eucalipto con anta battente chiusura ammortizzata, maniglia in pelle e ripiano interno in vetro extra chiaro. Libreria, espositore o fianco divano in vetro trasparente, extra chiaro o fumè con base a specchio e piedini regolabili. Disponibile in differenti altezze e larghezze. Opzionale cassetto laccato RAL o bianco con foro bifacciale o in legno Siberian Ash, Eucalipto o Noce Canaletto con maniglia in pelle o in finitura cuoio testa di moro con una maniglia.

Bookcase or showcase in transparent, extra clear or smoked glass with mirrored base and adjustable feet. Available in two heights and two widths and in version right or left for different composition proposals. Wooden storage unit in Siberian Ash, Eucalipto or natural oak with hinge door and soft closure, leather knob and internal extra clear glass shelf.

Bookcase, display unit or side table in transparent, extra clear or smoked glass with mirrored base and adjustable feet. Available in different heights and widths. Optional drawer white or RAL lacquered with double sided hole or in wood, Siberian Ash, Eucalipto or Canaletto Walnut with leather handle or in dark leather finish with handle.

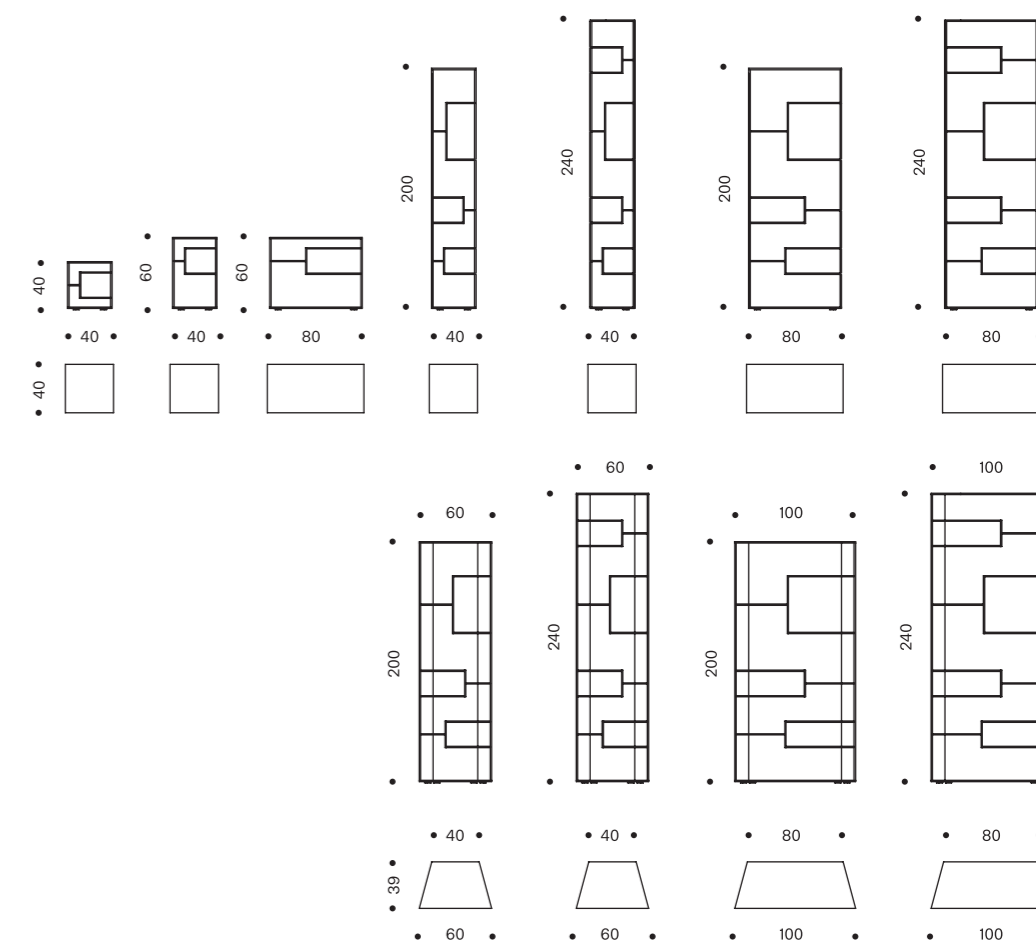



---

## SC005

**Soft Glass** Divano / Sofa  
Vetro bronzo, tessuto F 400  
Bronze glass, fabric F 400

**Sestante** Tavolini / Coffee Tables  
Vetro bronzo, Bronze glass

**Gerundio** Specchio / Mirror

**Hyperion** Lampada / Lamp  
Canna di fucile lucido, vetro pyrex soffiato trasparente  
Polished gunmetal, transparent blown pyrex glass



---

**Sestante**  
side / low tables  
console

design  
**Emilio Nanni**

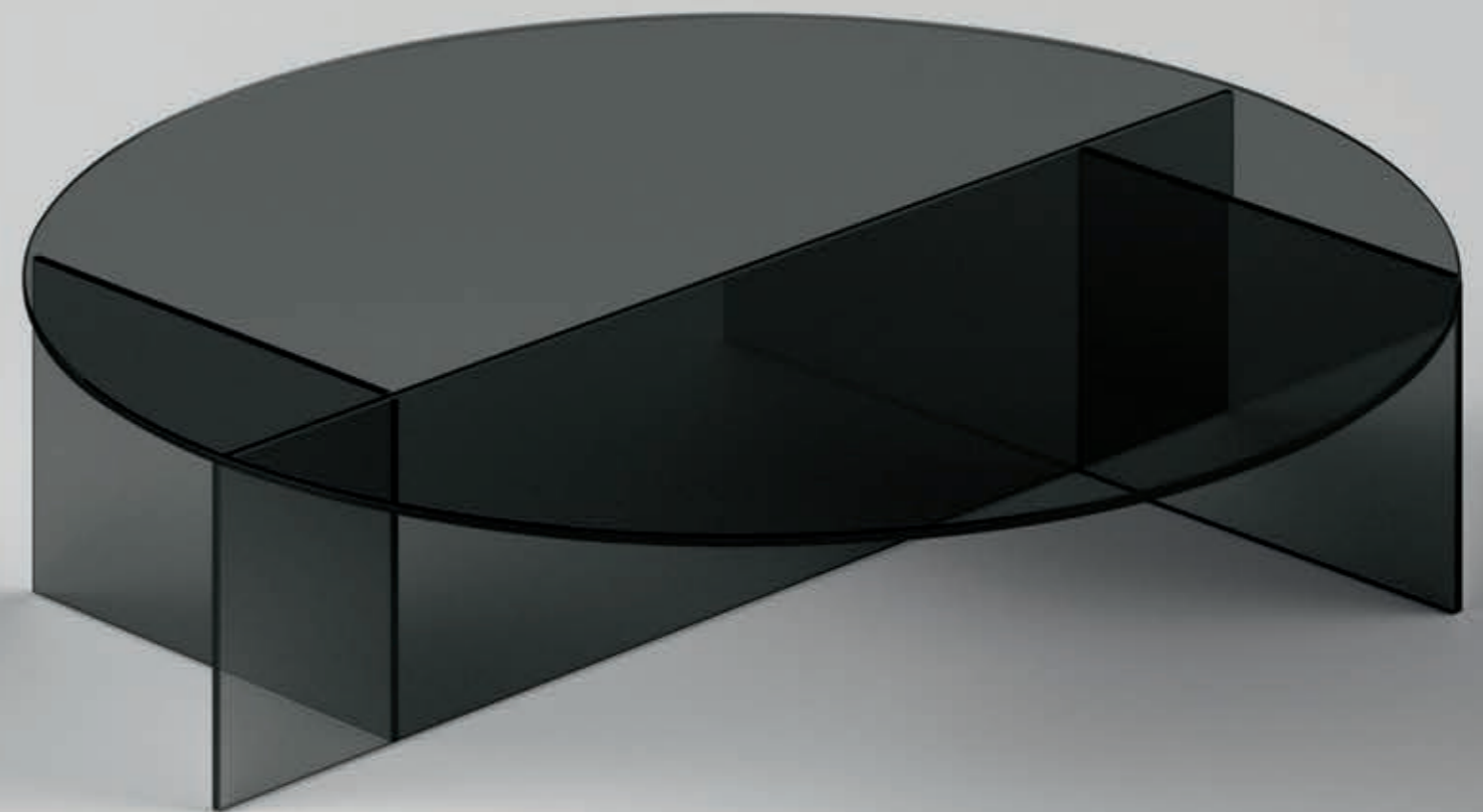

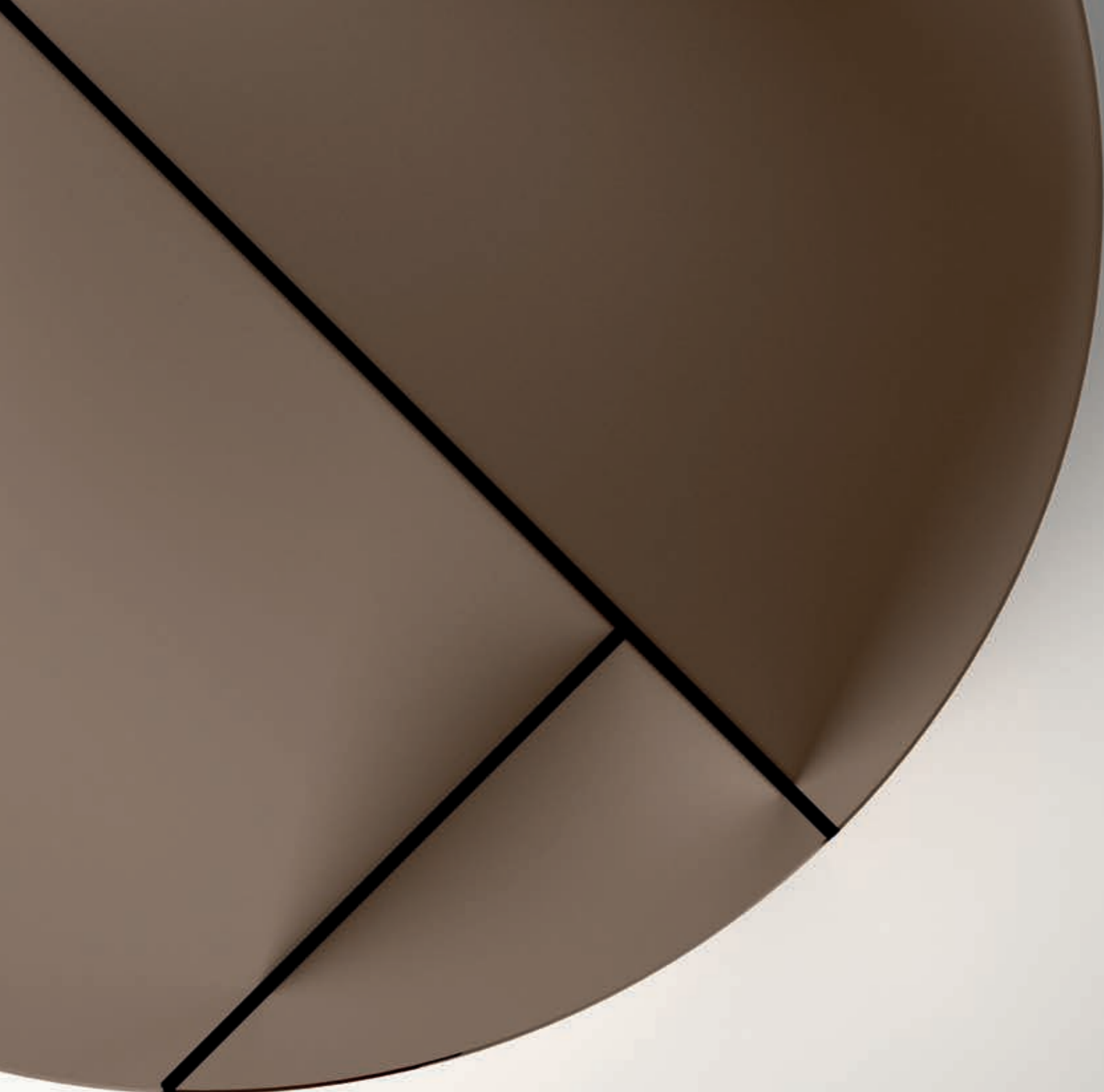

Le diverse dimensioni, disponibili in forme lineari o arrotondate, permettono ampia libertà compositiva. Le varie finiture in vetro danno vita a innumerevoli abbinamenti e personalizzazioni.

The several dimensions, available in linear or rounded shapes, allow for a great composition liberty. The different finishing of glass give life to numerous combinations and personalization.

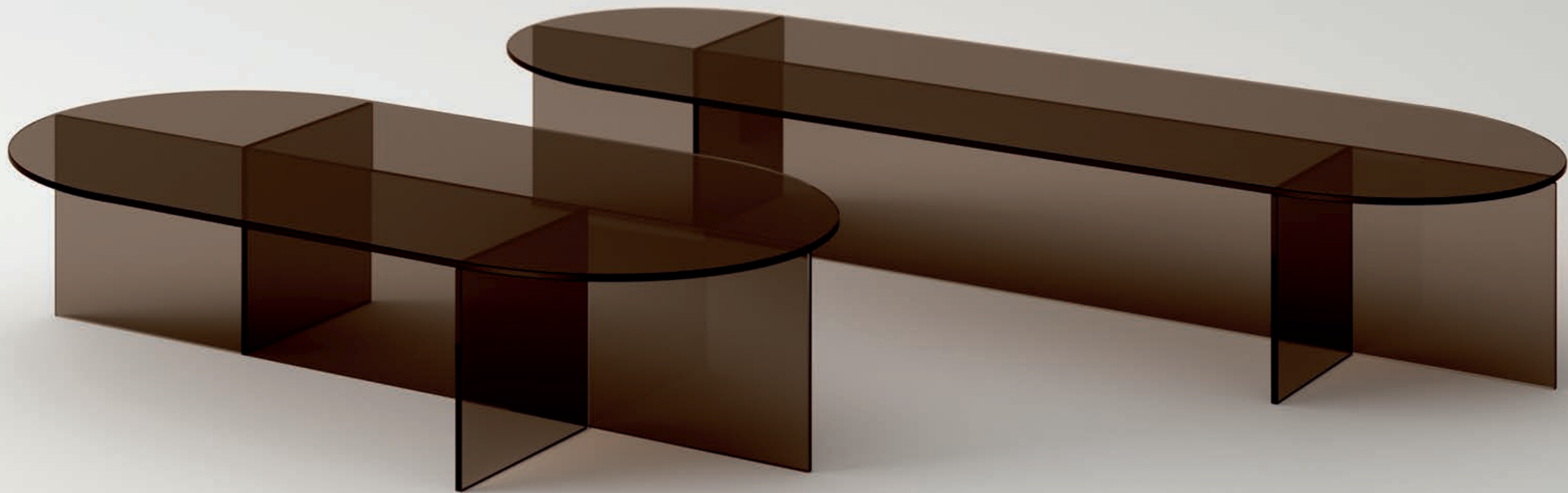





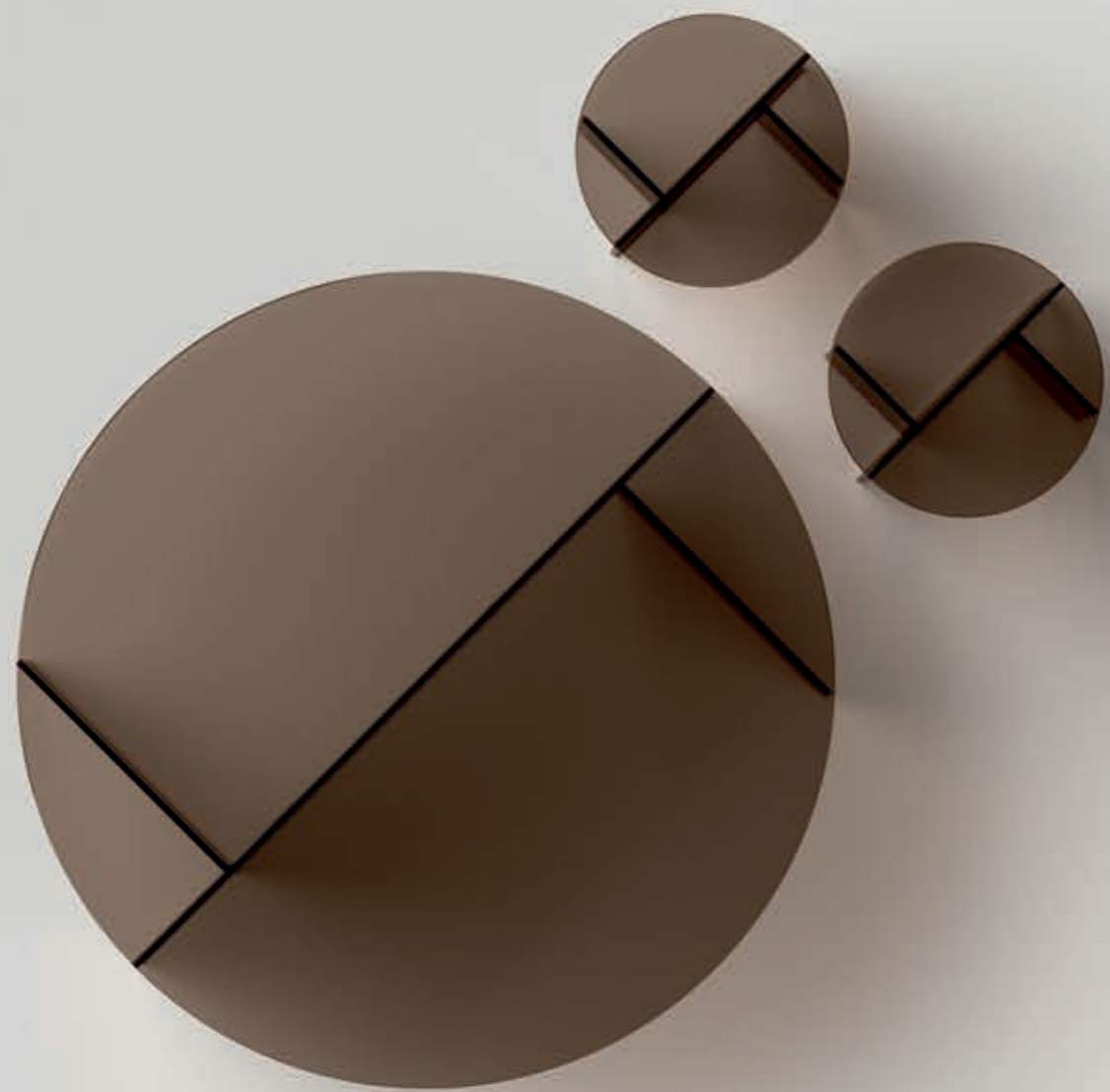

Tavoli bassi, fianchi divano e consolle in vetro saldato caratterizzati dal disegno rigoroso ed essenziale di elementi strutturali verticali, simmetrici e ortogonali.

Low tables, side tables and consoles in welded glass of a rigorous and essential design given by vertical, symmetrical and orthogonal structural elements.





## Sestante side / low tables console

design  
**Emilio Nanni**

### Info Tecniche / Technical Info

Collezione composta da consolle, tavoli bassi e fianchi divano. Disponibili in vetro saldato extra chiaro, fumé e bronzo.

Collection made of consoles, low tables and side tables. Available in extra clear smoked and bronze welded glass.

100x100 - H36  
130x70 - H36  
150x100 - H36  
150x150 - H36

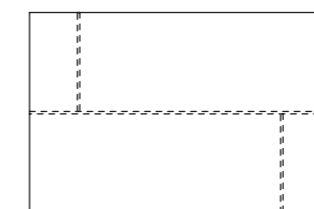

150x40 - H42  
120x40 - H72  
150x40 - H72

ø80 - H30  
ø100 - H30  
ø130 - H30  
ø150 - H30

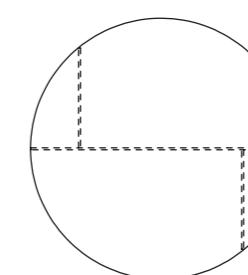

130x70 - H30  
150x80 - H30  
200 x 70 - H30

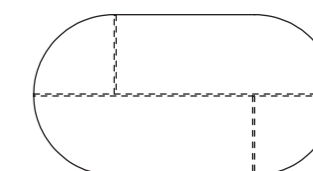

ø50 - H42  
ø50 - H54

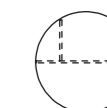

---

**Gerundio**  
mirror

design  
Giovanni Tommaso Garattoni



Gerundio è uno specchio di grandi dimensioni dove parte centrale e cornice esterna vengono tagliati da una unica lastra di specchio evitando in questo modo qualsiasi interruzione. Il risultato è uno specchio minimale e sofisticato che si adatta a qualsiasi ambiente, dalla zona living alla zona notte ad ambienti comuni.

Gerundio is a mirror of great dimensions where the central part and the external frame are cut out of a sole mirror panel, thus avoiding any kind of interruption. The result is a minimalistic and sophisticated mirror that adapts to any environment, from the living area to the bedroom and shared environments.



Nuove dimensioni oltre a quelle già esistenti si aggiungono per lo specchio Gerundio che, al di là del tempo e delle mode effimere, riesce sempre ad arredare lo spazio in modo originale.

New dimensions are added to the existing ones of the Gerundio mirror that, beyond time and fleeting trends, is always able to decorate a space in an original way.





## Gerundio mirror

design  
**Giovanni Tommaso Garattoni**

### Info Tecniche / Technical Info

Specchio da parete con struttura in legno verniciata nero. E' disponibile in specchio normale e nelle forme tonde, ovali, rettangolari e quadrate.

Wall mirror with black lacquered wooden structure. Available in normal mirror and in round, oval, rectangular or square shape.

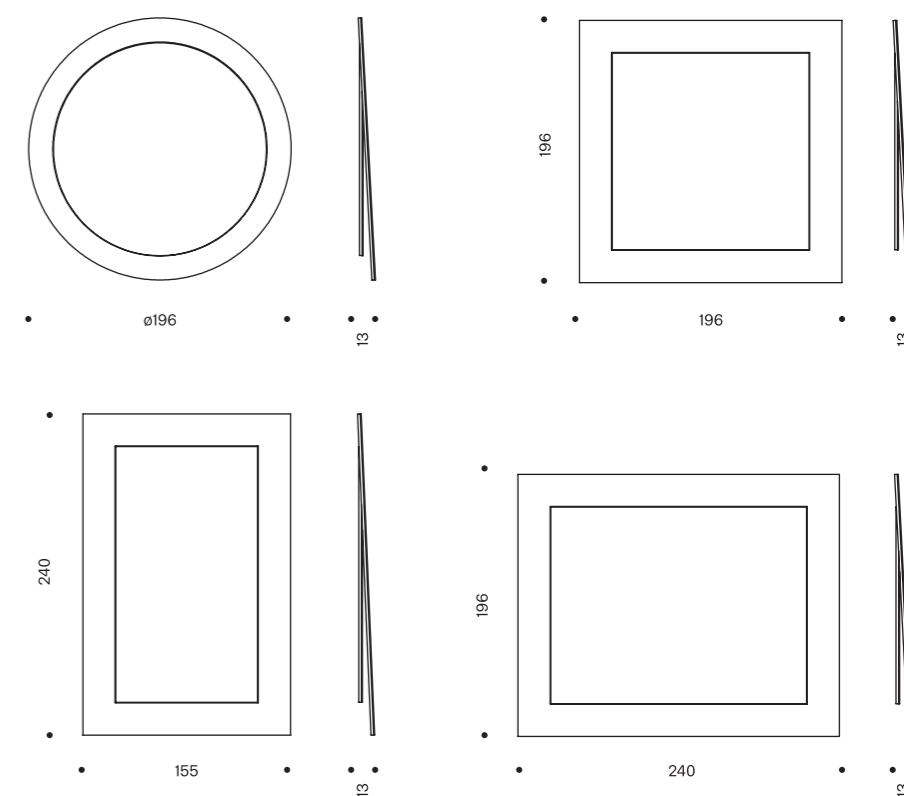

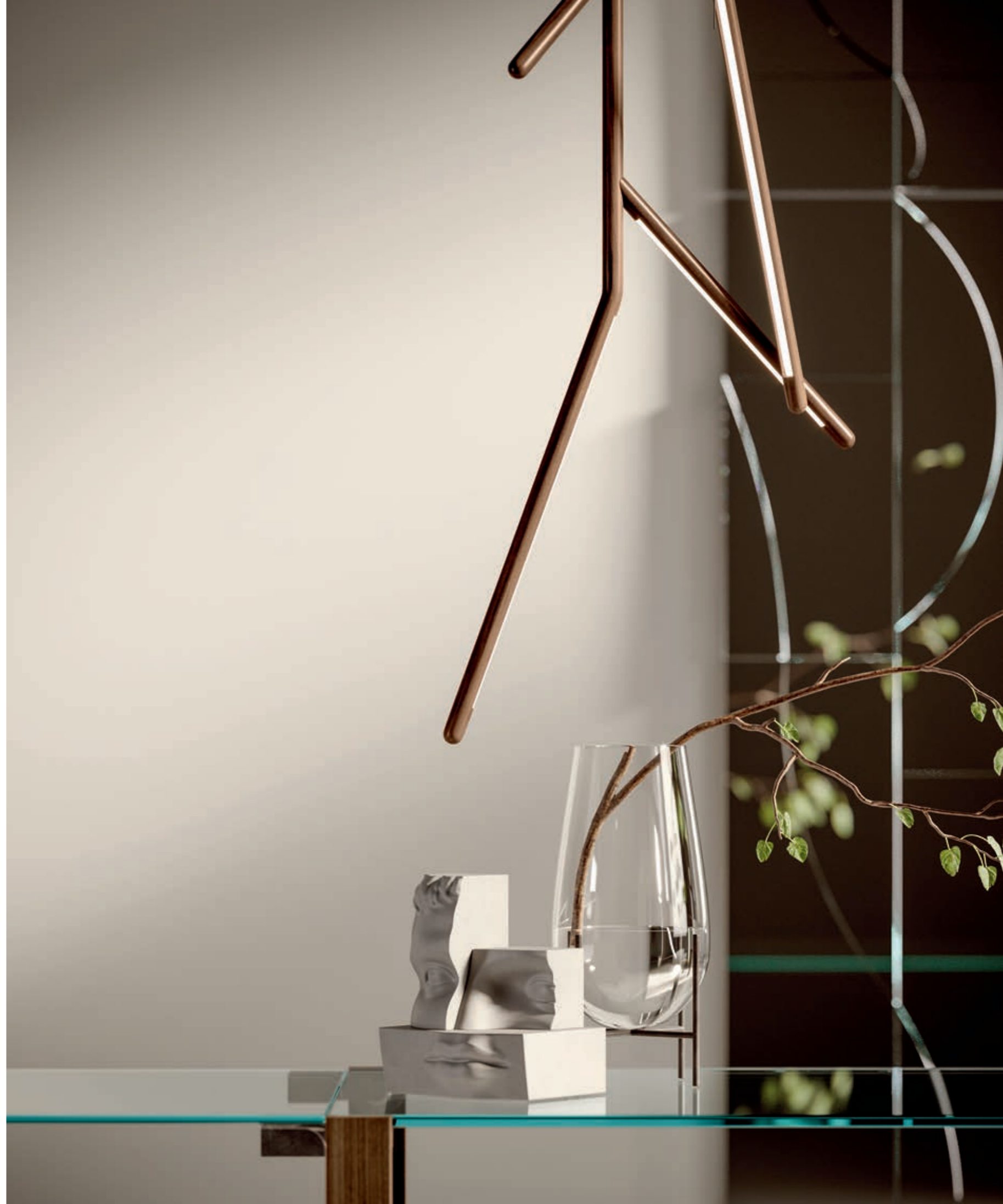



---

## SC006

**Livingstone** Tavolo / Table  
Vetro extrachiaro, gambe Eucalipto  
Extra clear glass, eucalypto legs

**AW\_chair** Sedia / Chair  
Eucalipto, tessuto F 400  
Eucalipto, fabric F 400

**Maybe** Specchio / Mirror

**Noum** Lampada / Lamp  
Eucalipto / eucalipto



---

**Livingstone**  
extending dining tables

design  
**Giulio Mancini**



La grande pulizia formale unita a contenuti tecnici di grande complessità, viene enfatizzata nel tavolo allungabile in vetro. Piani in vetro trasparente, extrachiaro e fumé o bronzo stratificato possono essere abbinati a svariate finiture di gambe.

The strong formal cleanliness combined with complex technical details is enhanced in the extending glass table. Table tops in stratified smoked or bronze glass or extra clear and transparent glass can be combined with a number of different leg finishes.

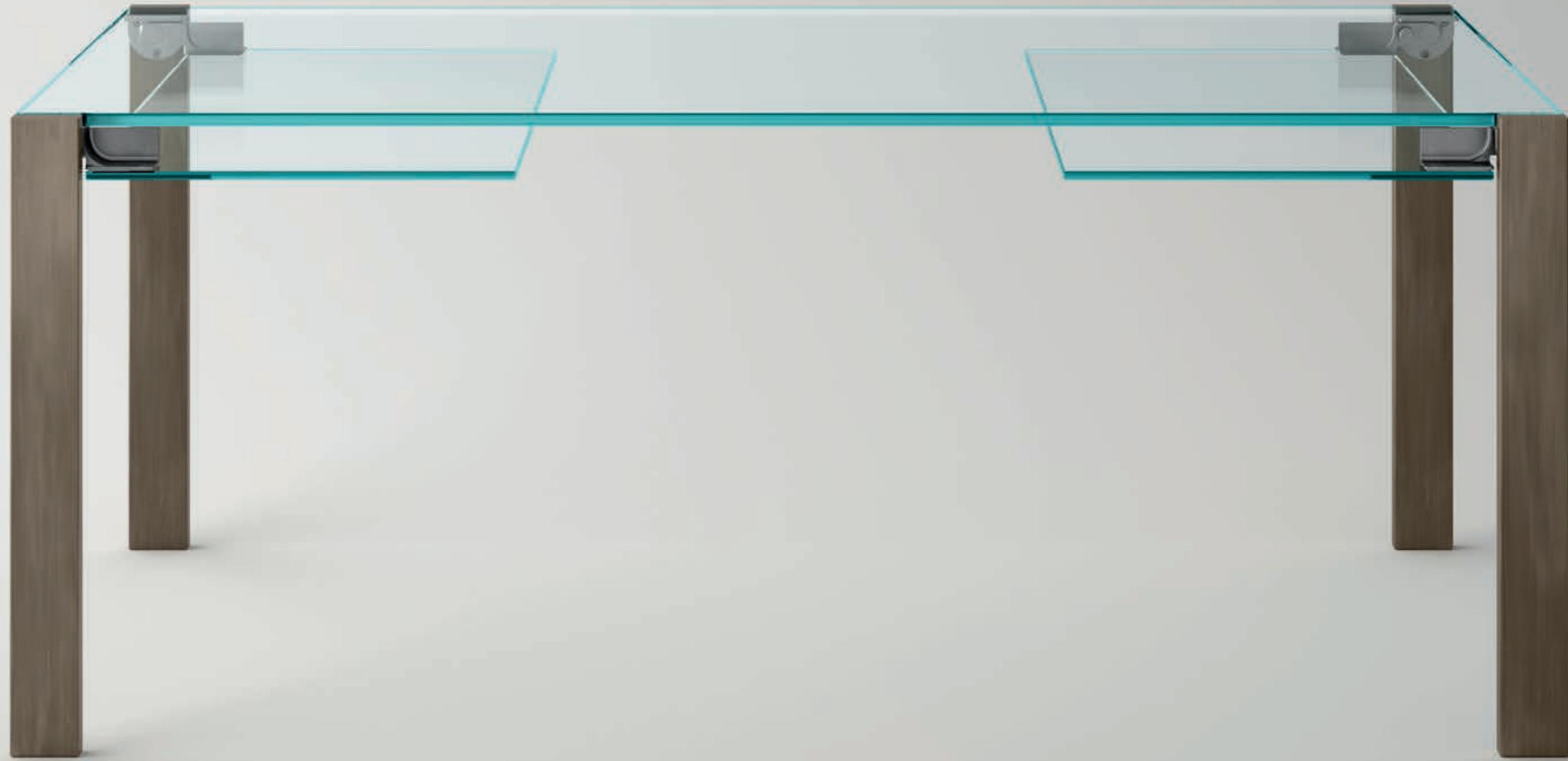







Il movimento di apertura e chiusura del tavolo, si compie con un semplice gesto, grazie al sistema di apertura degli allunghi in vetro realizzato con una speciale cerniera in fusione di acciaio inox.

The opening and closing of the table are done with a simple gesture, thanks to the opening system of the glass leaves made of a particular hinge in stainless steel casting.





## Livingstone extending dining tables

design  
**Giulio Mancini**

### INFO TECNICHE / TECHNICAL INFO

Tavolo allungabile in vetro temperato trasparente ed extrachiaro oppure vetro stratificato nelle finiture fumé e bronzo. Gambe nelle finiture di gamma che comprendono metalli, legni e pelli. Meccanismo di apertura degli allunghi brevettato con cerniera in fusione di acciaio inox.

Extending table in tempered transparent and extra clear glass or stratified glass available in smoked or bronze finish. Legs in metal, wood and leather of the Tonelli range finishes. Patented opening mechanism for the extending leaves in stainless steel casting.

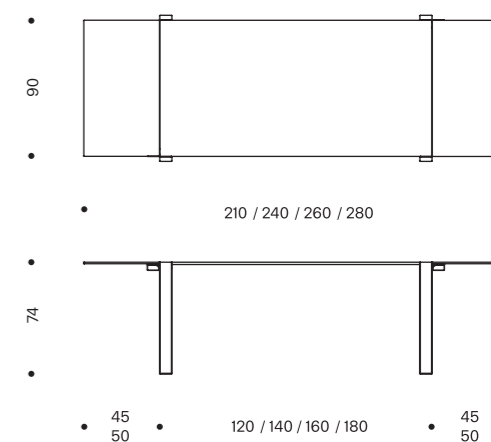



---

## Maybe mirror

design  
**Massimo Castagna**

Specchio da parete pensato per creare diverse composizioni grazie al suo segno grafico. Una texture molto elegante e raffinata ottenuta dalla sovrapposizione di specchi diversi per forma e dimensione.

Wall mirror intended for the creation of different compositions thanks to its graphic design. A very elegant and refined texture obtained by the juxtaposition of mirrors of different shapes and dimensions.





## Maybe mirror

design  
**Massimo Castagna**

### INFO TECNICHE / TECHNICAL INFO

Specchio modulare a parete realizzato con struttura in legno. E' disponibile in specchio, specchio oro, bronzo o fumé.

Modular wall mirror made with wooden structure. Available in mirror, gold, bronze or smoked mirror.

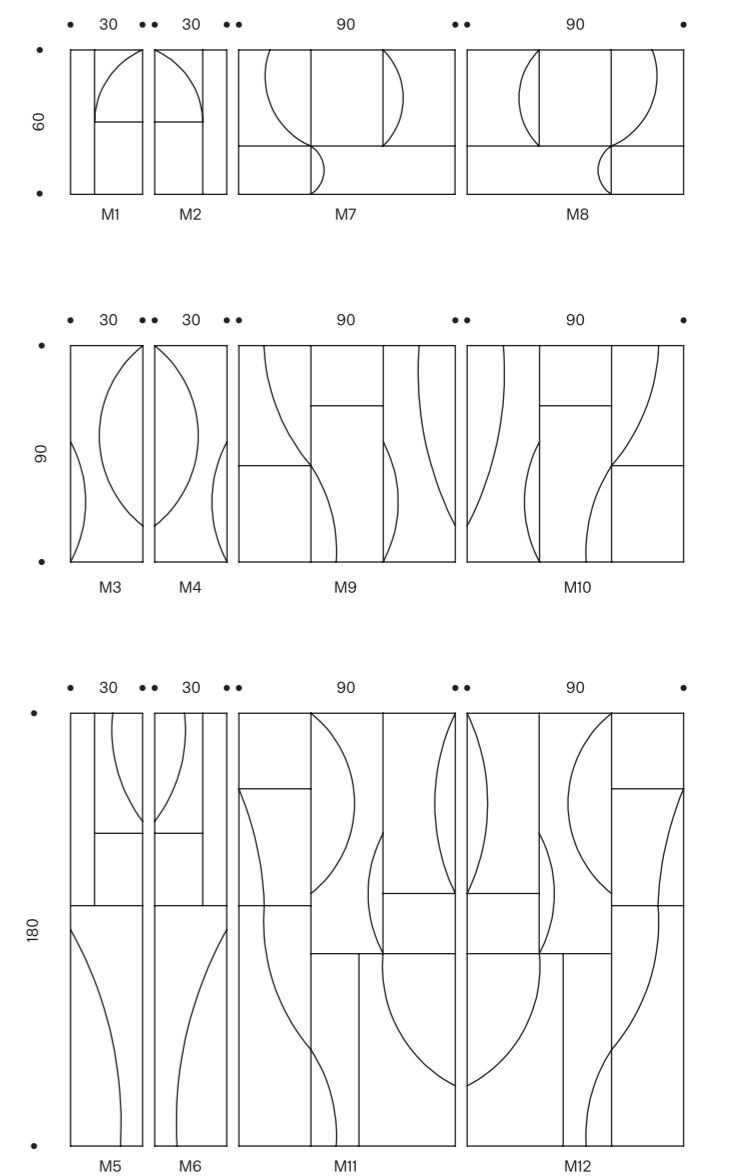



---

## SC007

**Metropolis** Tavolo / Table  
Vetro fumè, smoked glass

**AW\_chair** Sedia / Chair  
Eucalipto, tessuto F 314  
Eucalipto, fabric F 314

**Hyperion** Lampada / lamp  
Canna di fucile lucido, vetro pyrex soffiato trasparente  
Polished gunmetal, transparent blown pyrex glass

**Sestante\_Stone** Consolle / Console  
Marmo Arabescato Orobico Gold, vetro fumè  
Arabescato Orobico Gold marble, smoked glass

**Beryl** Specchio / Mirror  
Specchio fumè, smoked mirror



---

## Metropolis fused glass dining tables

design  
**Giuseppe Maurizio Scutellà**

Il tavolo Metropolis fused glass con il top in vetro fuso, si aggiunge alla esistente e ampia collezione Metropolis. Il piano rettangolare stondato con l'effetto materico del vetro fuso contrasta con il rigore e la pulizia del basamento. Essenziale ed eclettico, in questa nuova veste Metropolis è il tavolo perfetto per una casa moderna ed accogliente.

The Metropolis with fused glass top is being added to the existing and ample collection of Metropolis. The shaped rectangular top with the materic effect of the fused glass contrasts with the rigour and clean lines of the base. Essential and eclectic, this new version of Metropolis is perfect for a modern and charming home.



---

## Metropolis dining tables

design  
**Giuseppe Maurizio Scutellà**

La forma pulita ed articolata del basamento di questo tavolo di design abbinata alle diverse dimensioni del piano offre più spazio ai commensali coniugando stabilità e comfort.

The clean and articulate shape of this designer table's base combined with the different dimensions of the top offers more space for guests uniting stability and comfort.

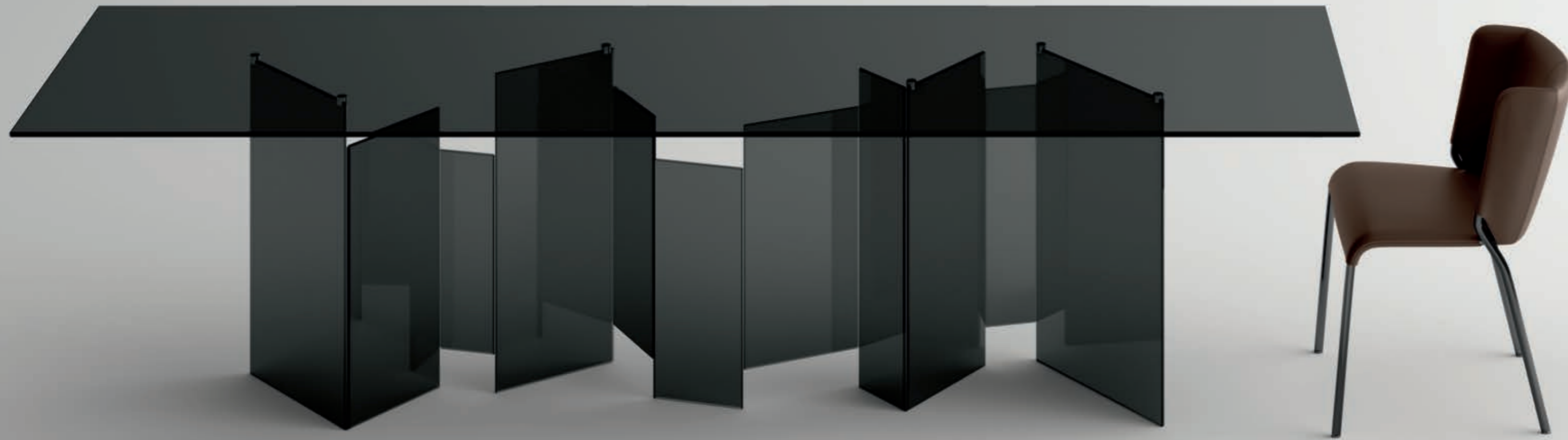

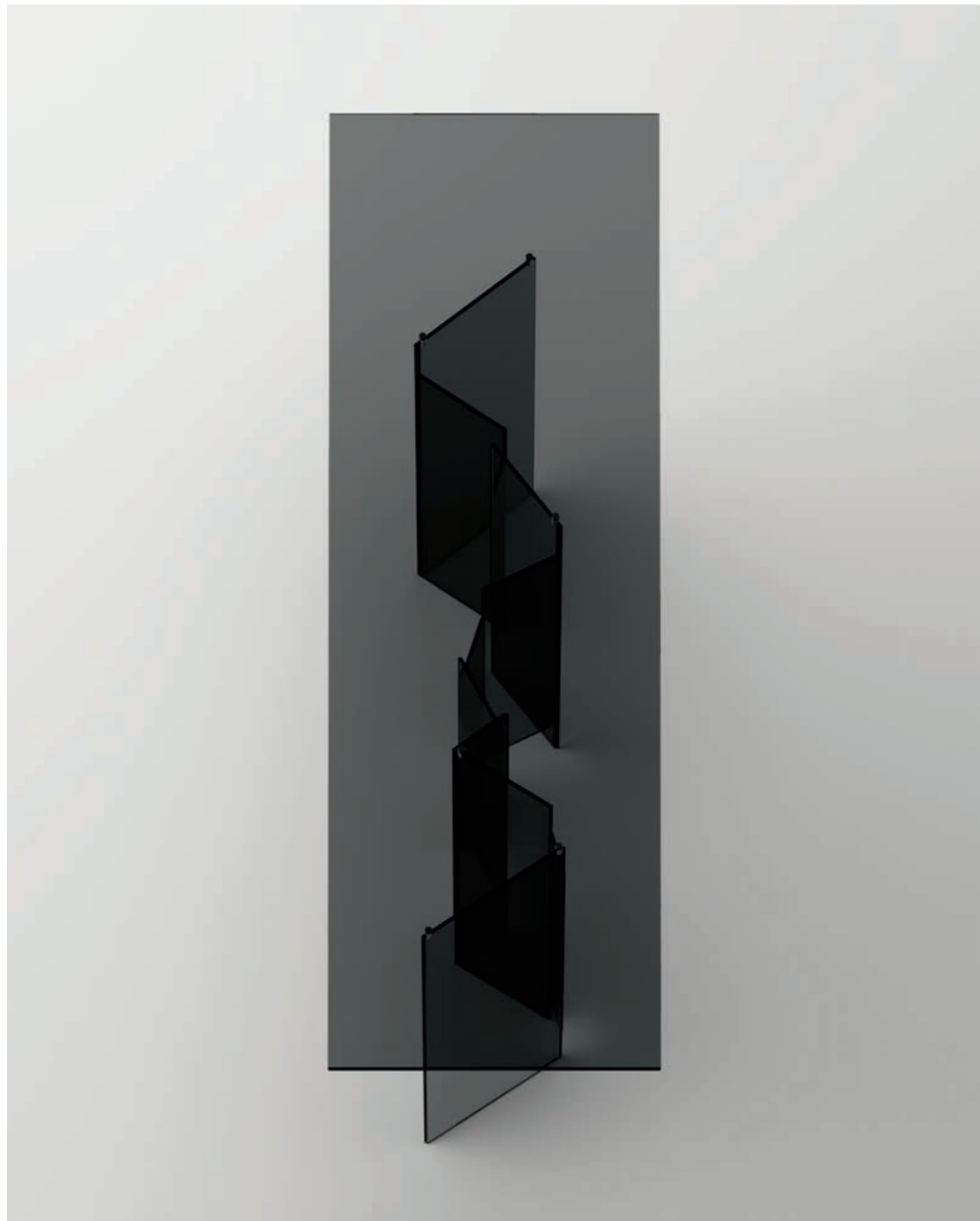

## Metropolis fused glass / Metropolis dining tables

design  
Giuseppe Maurizio Scutellà

### Info Tecniche / Technical Info

Tavolo con piano in appoggio, in vetro extra chiaro o fumè temperato oppure vetro fuso fumè. Il basamento, formato da più parti di vetro saldate assieme, sorregge i piani di svariate forme e dimensioni. I piani e i basamenti possono avere la stessa finitura oppure essere combinati tra di loro.

Table with top in tempered extra clear or smoked glass or fused smoked glass. The base, made of several welded glass parts, supports tops of various shapes and dimensions. Tops and bases, in extra clear or smoked glass, can have the same finish or a combination of the two.

Piano vetro fuso  
Fused glass Top  
200x110  
220x110  
240x110  
260x110  
280x110  
300x110  
320x120

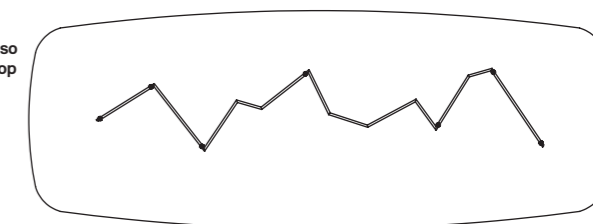

Piano / Top  
200x100  
225x90  
240x100  
245x120  
260x100  
280x100  
300x100

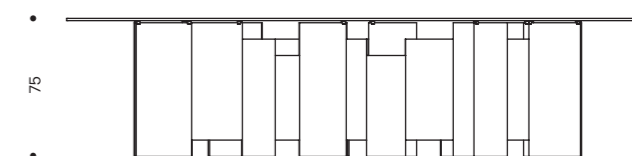
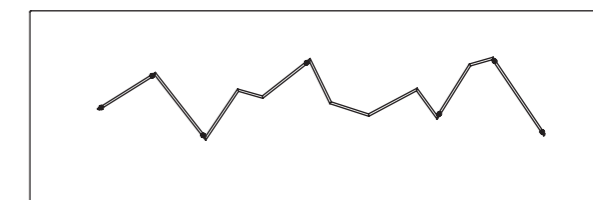

---

**Sestante\_Stone**  
console  
low tables

design  
Emilio Nanni

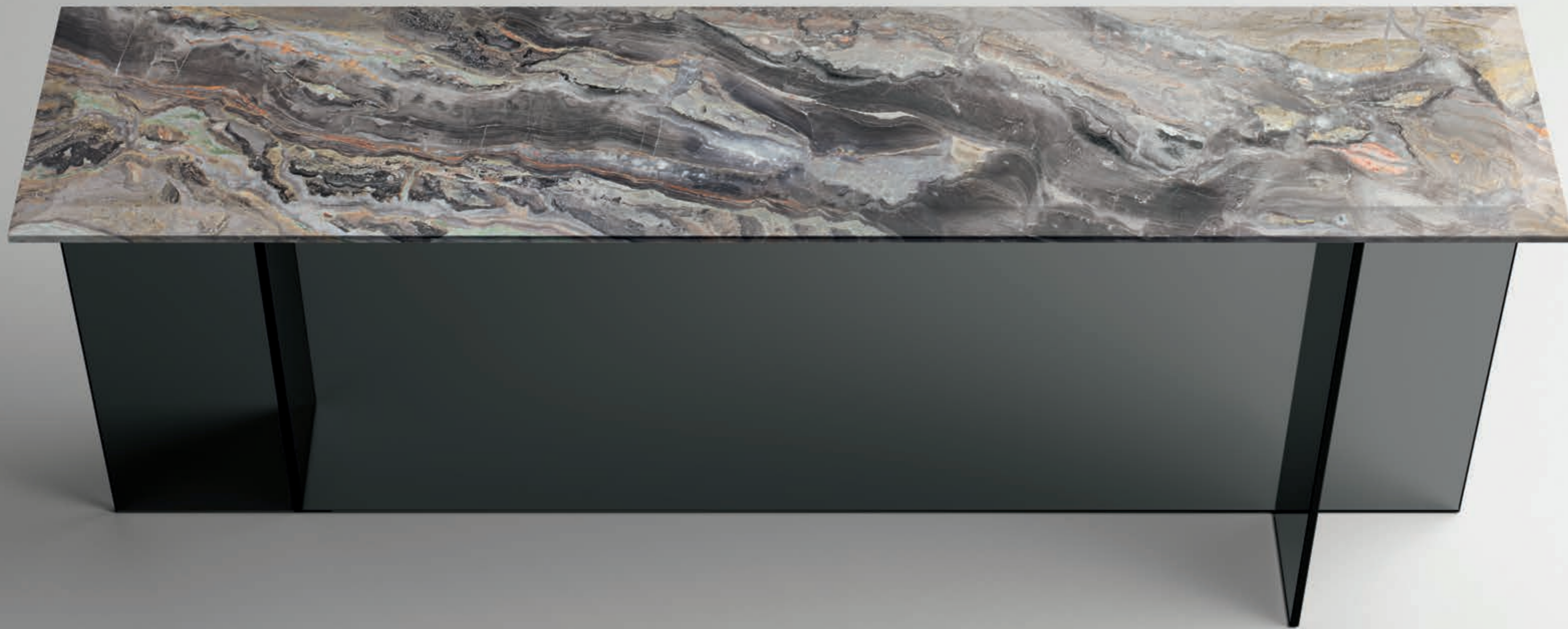



Tavoli bassi e consolle caratterizzati dal disegno rigoroso ed essenziale di elementi strutturali verticali, simmetrici e ortogonali. Base in vetro incollato e top in marmo spazzolato opaco, con bisellatura a vista sul piano.

Low tables and console of a rigorous and essential design given by vertical, symmetrical and orthogonal structural elements. Base in glued glass and top in matt brushed marble with visible beveled edge on the top.



Le diverse dimensioni disponibili, permettono ampia libertà compositiva. Le varie finiture di basi in vetro e top in marmo, danno vita a innumerevoli abbinamenti e personalizzazioni.

The several available dimensions allow for a great composition liberty. The different finishing of glass base and marble top give life to numerous combinations and personalization.







## Sestante\_Stone console low tables

design  
**Emilio Nanni**

### INFO TECNICHE / TECHNICAL INFO

Collezione composta da consolle e tavoli bassi. Basi in vetro fumé o extrachiaro. Top in marmo spazzolato opaco, con bisellatura a vista, disponibile in Arabescato Orobico Gold, Tropikal Storm o Domus White.

Collection made of console and low tables. Bases in smoked or extra clear glass. Top in matt brushed marble, with bevelling on sight, available in Arabescato Orobico Gold, Tropikal Storm or Domus White.

Piano / Top  
120 x 40  
150 x 40  
180 x 40

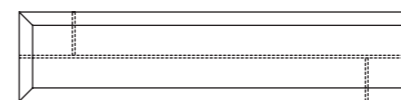

• 73 •



Piano / Top  
100 x 100  
130 x 70  
150 x 100  
150 x 150

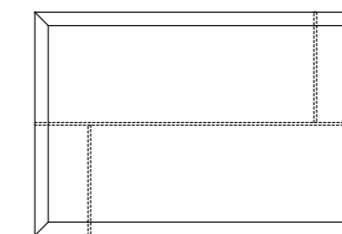

• 37 •



Piano / Top  
150 x 40

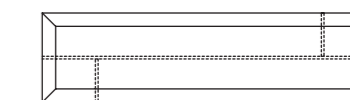

• 43 •





---

## SC008

**Hybrid** Tavolo / Table  
Vetro fumè, Siberian Ash, Canna di fucile lucido  
Smoked glass, Siberian Ash, Polished gunmetal

**She** Sedia / Chair  
Canna di fucile lucido, pelle marrone scuro 5400  
Polished gunmetal, dark brown leather 5400

**Liber** Libreria / Bookcase  
Vetro extrachiaro / Extra clear glass

**Noum** Lampada / Lamp  
Siberian Ash



---

## Hybrid dining tables

design  
**Massimo Castagna**

Il tratto ritmato dei listelli di legno che compongono il basamento fanno di Hybrid un tavolo dal grande fascino contemporaneo. L'alternanza dei materiali tra base e piano esprime il carattere progettuale del tavolo e offre spazio alla personalizzazione permettendo di integrarsi con ogni modello di casa.

The rhythmic pace of the wooden strips composing the base of Hybrid make it a table of great contemporary charm. The alternation of materials between base and top express the design feature of the table and offers space to personalization allowing it to match any home model.

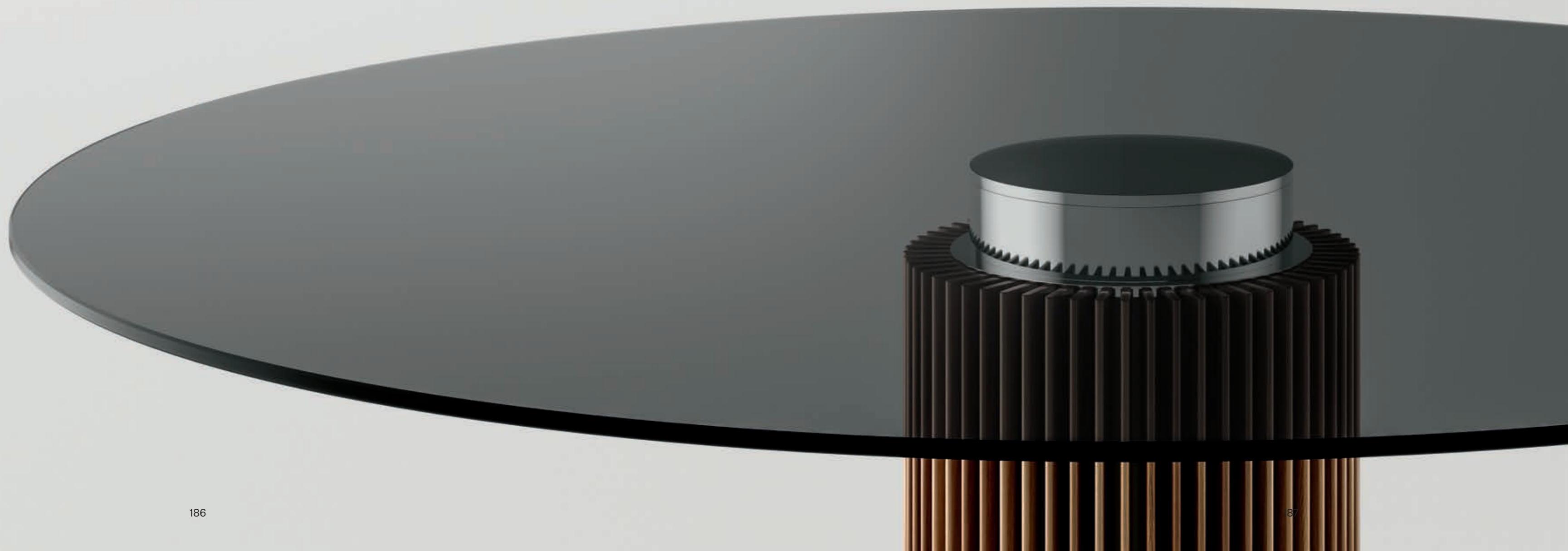

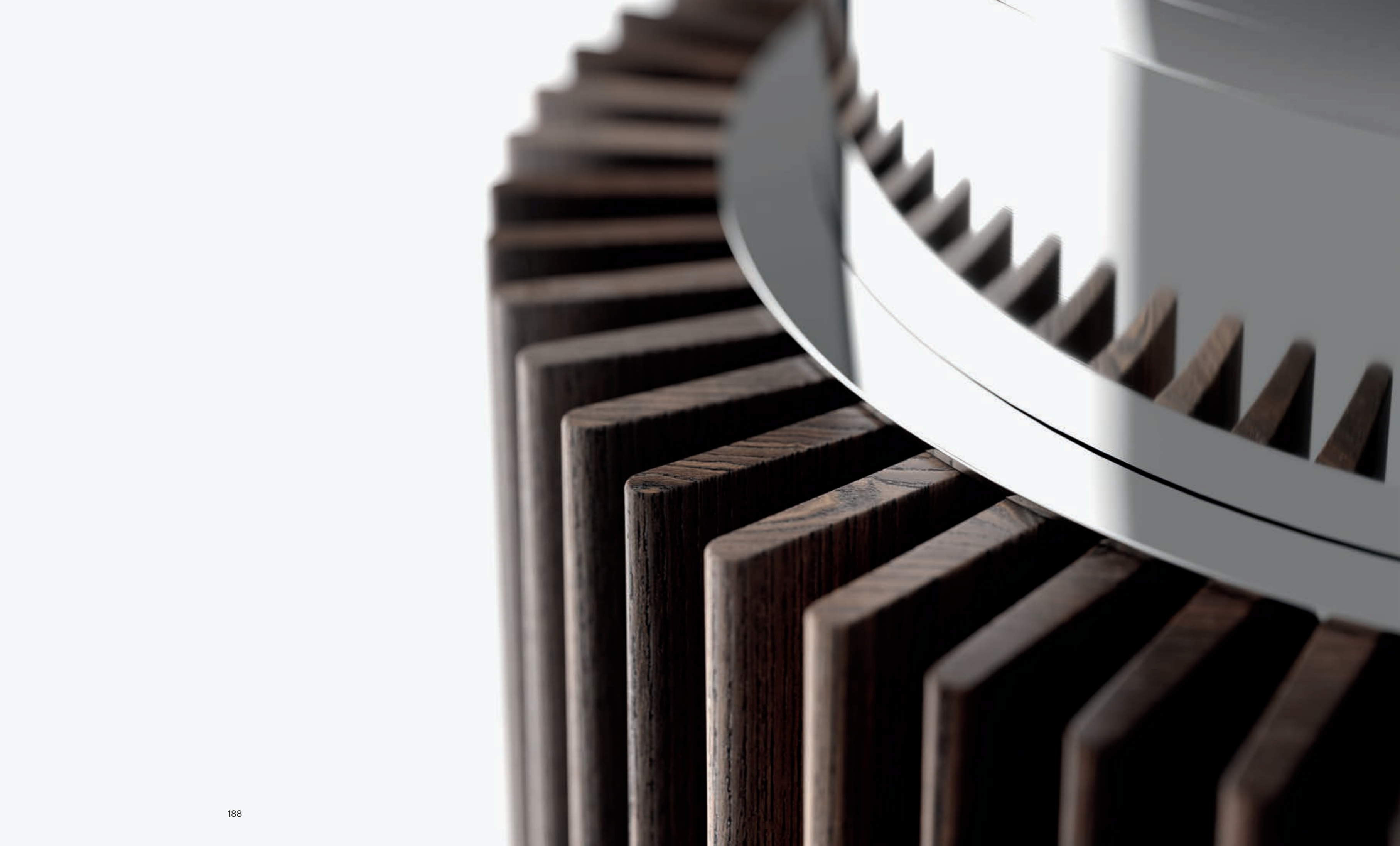



Il bordo smussato dona morbidezza al piano in vetro e dialoga con la lavorazione artigianale dei listelli in legno massello. Le parti in metallo lucido garantiscono solidità al tavolo e ne esaltano lo stile essenziale ed elegante.

The bevelled edge gives softness to the glass top and confers with the craftsmanship of the solid wooden strips. The polished metal parts grant the table solidity and enhance the essential and elegant style.

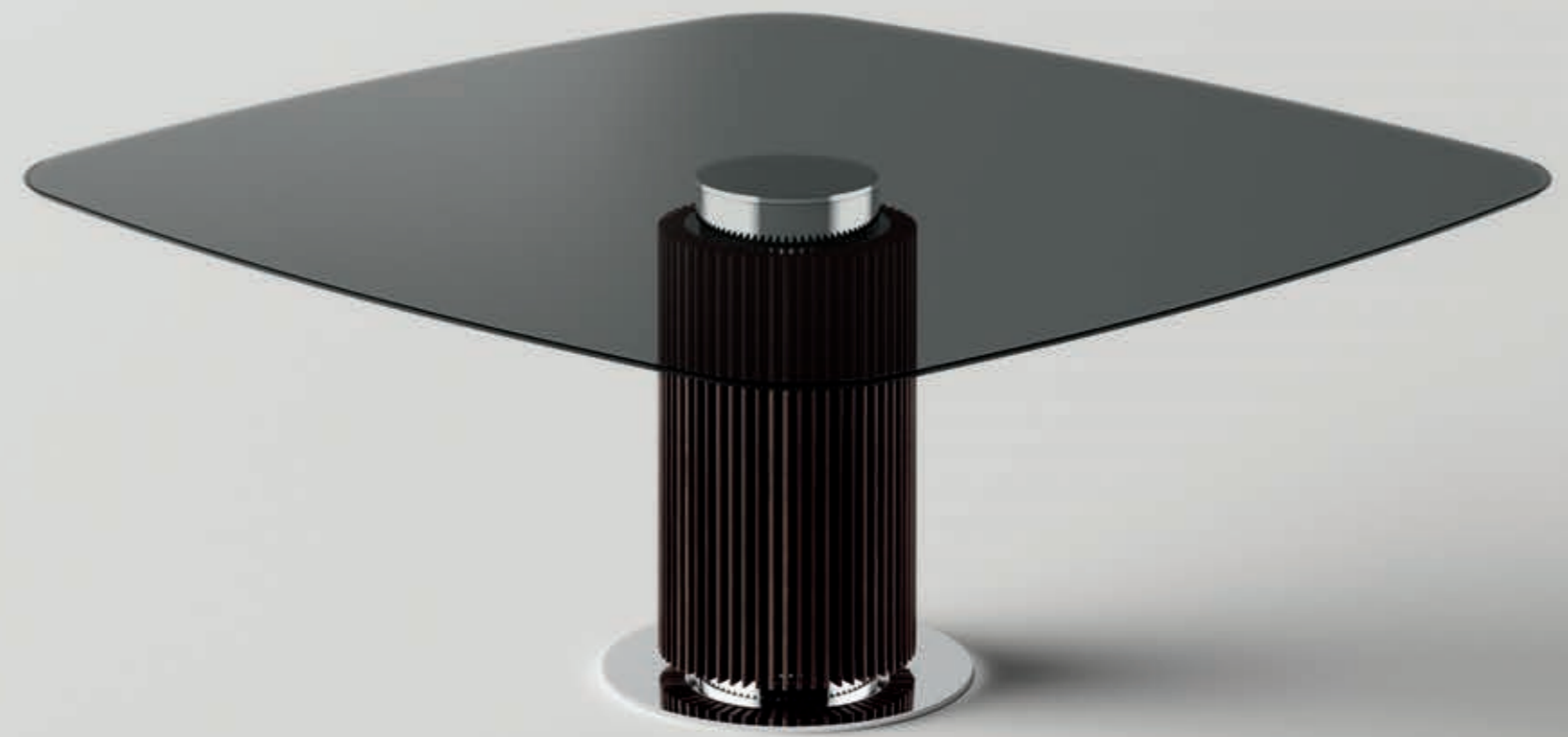



## Hybrid dining tables

design  
**Massimo Castagna**

### INFO TECNICHE / TECHNICAL INFO

Tavolo con basamento centrale composto da listelli in legno massello Siberian Ash, Eucalipto o Rovere naturale e parte superiore in metallo in finitura cromato lucido. Base a terra in finitura cromato lucido o canna di fucile lucido. I piani in vetro extra chiaro o fumè temperato hanno sempre il bordo smussato e sono disponibili nelle versioni tonde e quadrate o rettangolari sagomate.

Table with central base made of solid wood strips in Siberian Ash, Eucalipto or natural oak and upper metal part in polished chrome finish. Bottom plate in polished chrome or polished gunmetal finish. Table tops in tempered extra clear or smoked glass always have a bevelled edge and are available in round and square or shaped rectangular form.

Piano / Top  
140x140 / 160x160 / 180x180

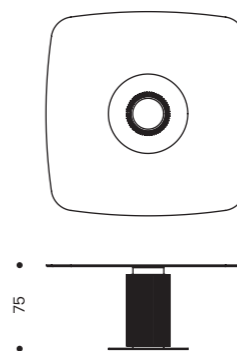

Piano / Top  
ø140 / ø160 / ø180

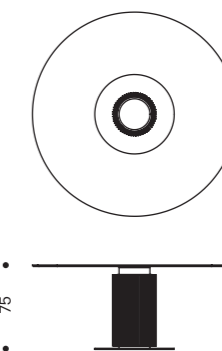

Piano / Top  
180x110 / 200x110

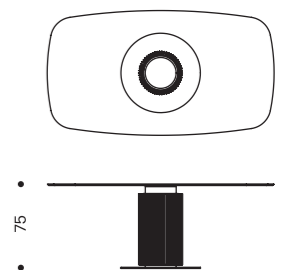

---

## She chair

design  
**Massimo Castagna**

Dal design contemporaneo, la sedia She è frutto dell'incontro tra innovazione tecnologica e lavorazione artigianale.

A contemporary design, the She chair is the result of the encounter between technological innovation and artisan processing.



She è caratterizzata da una struttura in tondino metallico piegato e da una imbottitura finemente lavorata con cuciture esterne per una funzione sia tecnica che estetica. Ideale sia nel contesto domestico che in ambito contract grazie al suo design senza tempo e alla sua grande comodità.

She is characterized by a structure made of bent metal rod and upholstery finely processed with external stitching granting both technical and aesthetic functionality. Ideal for either domestic use or for contract thanks to its timeless design and great comfort.







La sedia She si arricchisce di nuove finiture ed è ora disponibile anche nella versione tessuto. Materici o lisci, neutri o colorati, i rivestimenti si possono combinare con le finiture delle strutture per poter arredare in modo confortevole e contemporaneo case di diversi stili.

The She chair is enriched by new finishes and is now available in fabric version. Materic or smooth, neutral or coloured, the coverings can be combined with the finishes of the structure for the comfortable and contemporary furnishing of homes of different styles.











---

## She chair

design  
**Massimo Castagna**

### INFO TECNICHE / TECHNICAL INFO

Sedia con struttura in tubolare di metallo da 20mm, disponibile nelle finiture cromo lucido e canna di fucile lucido oppure verniciata gofrata nero, grigio antracite e bianco. Seduta e schienale imbottiti in pelle, ecopelle o rivestiti in tessuto F o P.

Chair with rod shaped metal structure of 20mm, available in following finishes: polished chrome and polished gunmetal or embossed matt black, white or anthracite grey lacquered. Upholstered seat and backrest in leather, faux leather or fabric F or P.

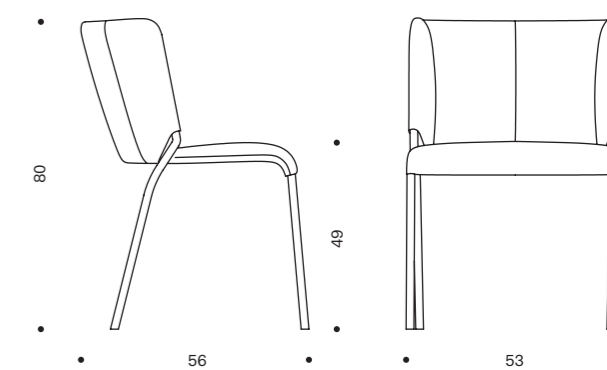

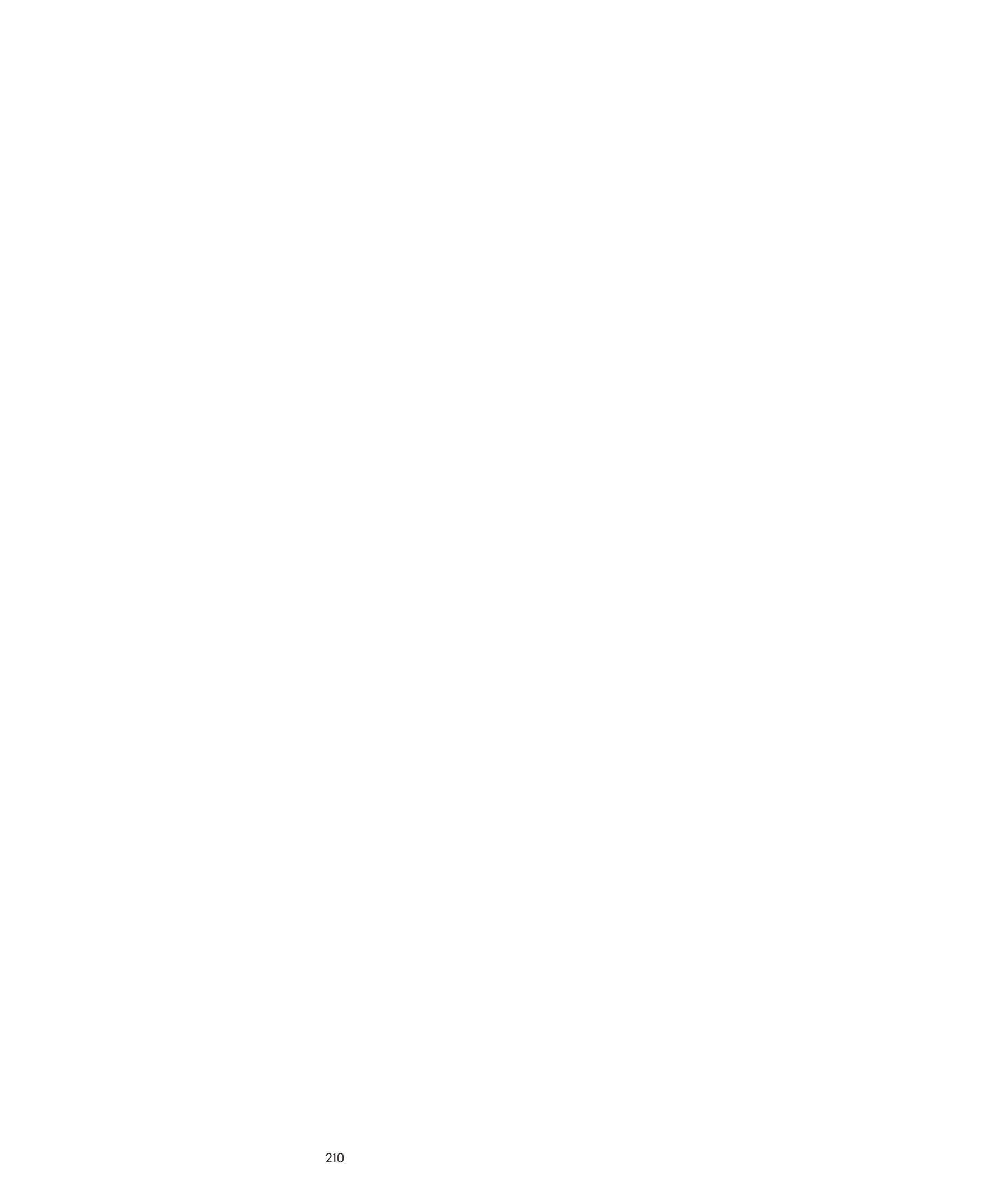

---

## SC009

**Thrim** Tavolo / Table  
Vetro bronzo, Bronze glass

**She** Sedia / Chair  
Cromo lucido, pelle grigio 5290  
Polished chrome, grey leather 5290

**Shoji** Cabinet Highboard  
Siberian Ash, vetro extrachiaro  
Siberian Ash, extra clear glass

**Noum** Lampada / Lamp  
Siberian Ash



---

## Thrim fused glass dining table

design  
**Massimo Castagna**

Il design puro ed essenziale di Thrim declinato nel vetro fuso per il top, ne fa un tavolo sofisticato ed elegante. Ricerca e tecnologia si incontrano per dare vita ad una perfetta combinazione di materiali attraverso un prodotto dalla forte personalità.

The pure and essential design of Thrim interpreted with the fused glass for the top makes it a sophisticated and elegant table. Research and technology meet up to give life to a perfect combination of materials through a product of great character.



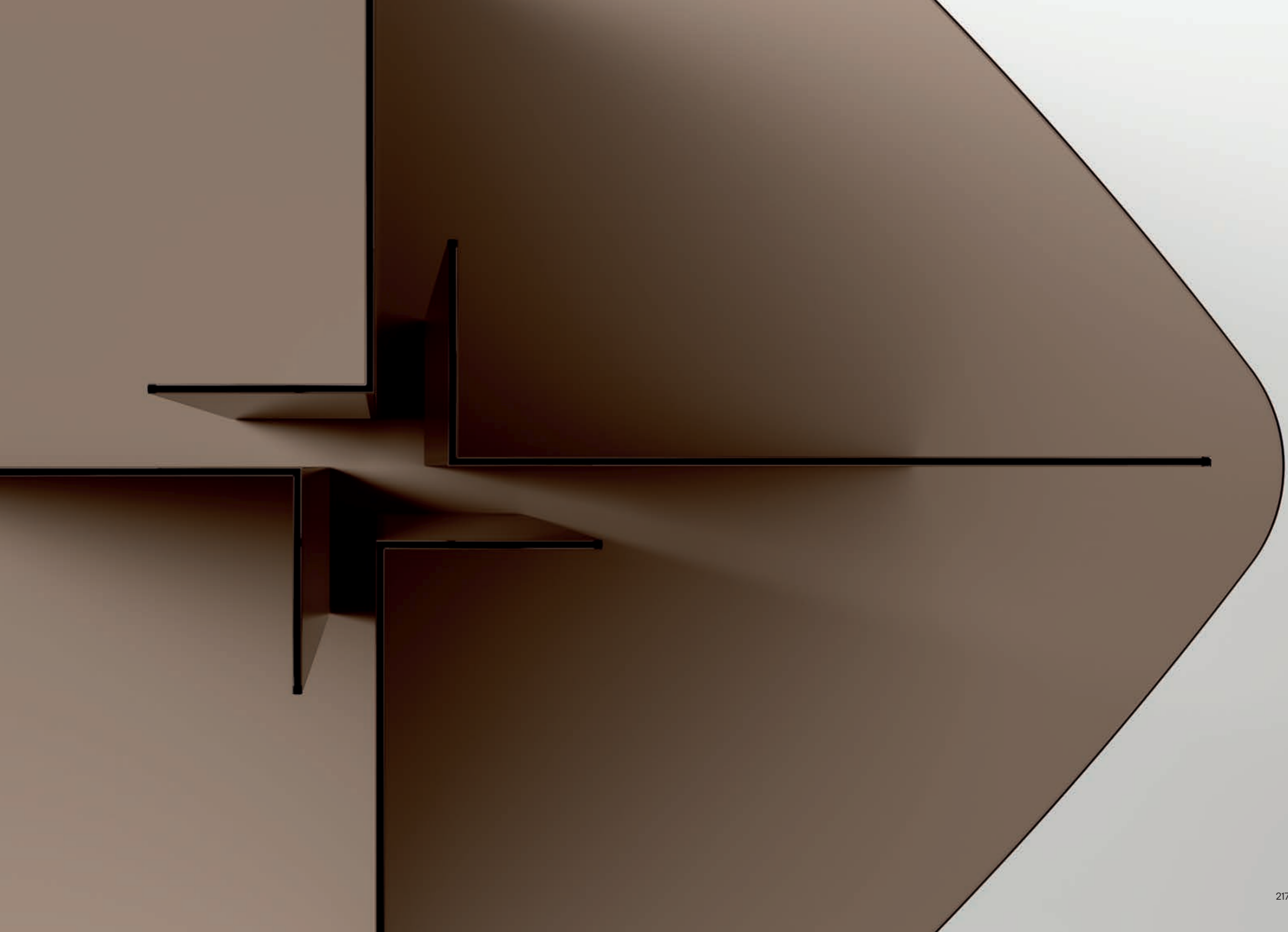

---

## Thrim dining table

design  
**Massimo Castagna**

Le basi di vetro del tavolo Thrim seguono la forma del piano in un gioco di diverse angolazioni e lunghezze. L'ampia disponibilità di configurazioni e dimensioni lo rendono fortemente personalizzabile e protagonista assoluto della zona dining.

The bases of table Thrim follow the top playing with different angles and lengths. The vast availability of configurations and dimensions give space to many customizations and make it the star of the dining area.

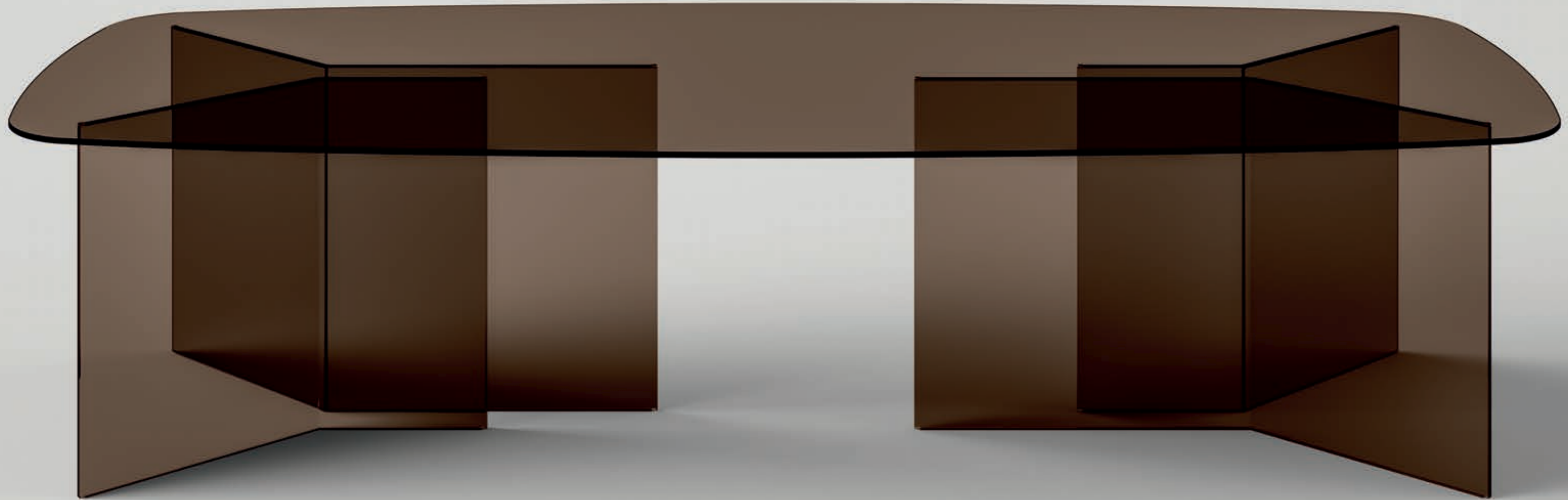

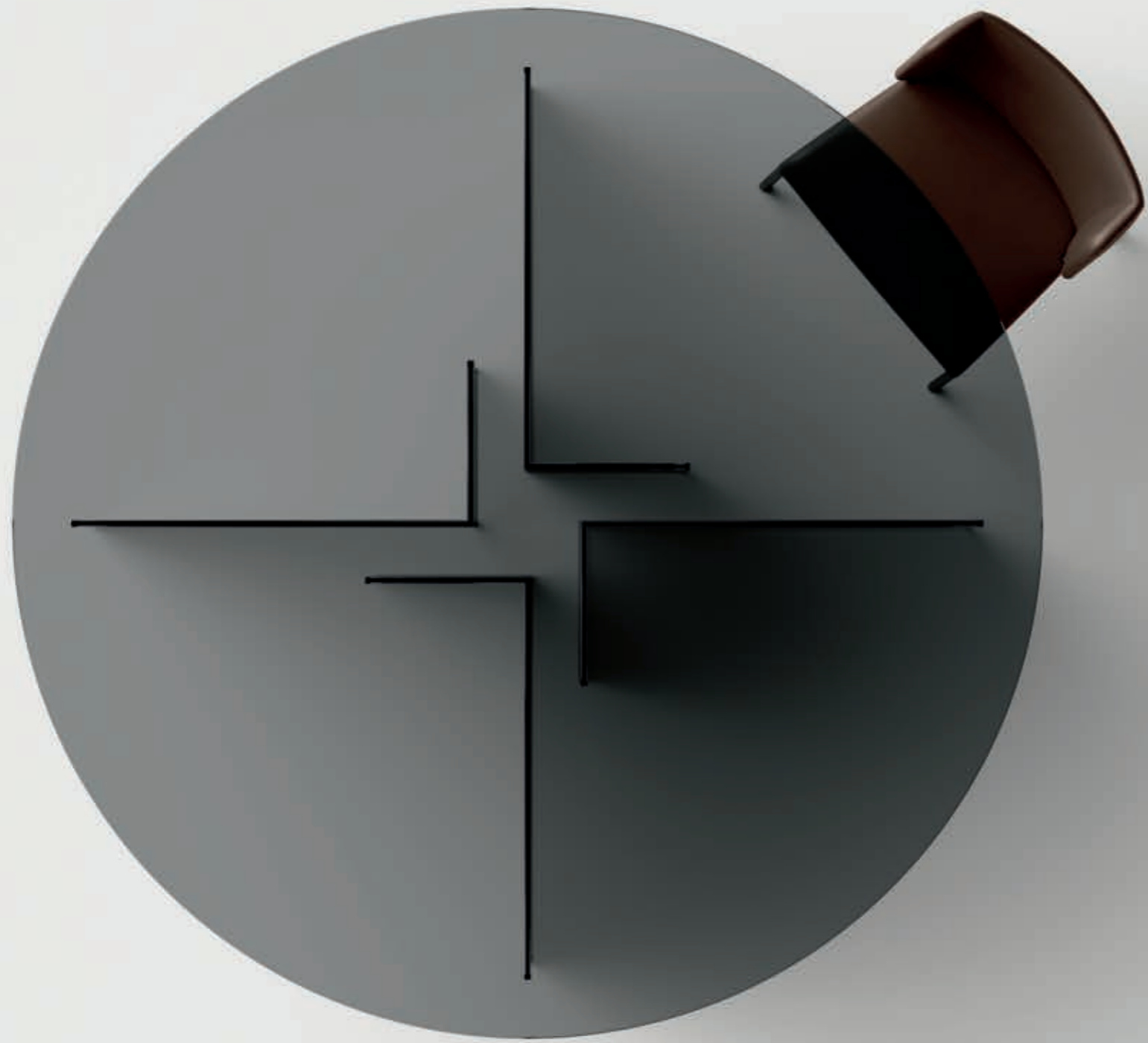



Nel tavolo Thrim vive l'essenza della conoscenza ed esperienza nella lavorazione del vetro. Un unico materiale che dà vita ad un prodotto di grande versatilità d'uso nei diversi progetti di interiors.

Table Thrim represents the very essence of the glass manufacturing knowledge and experience. A single material that gives life to a product of great versatility, to be used in a variety of interior design projects.

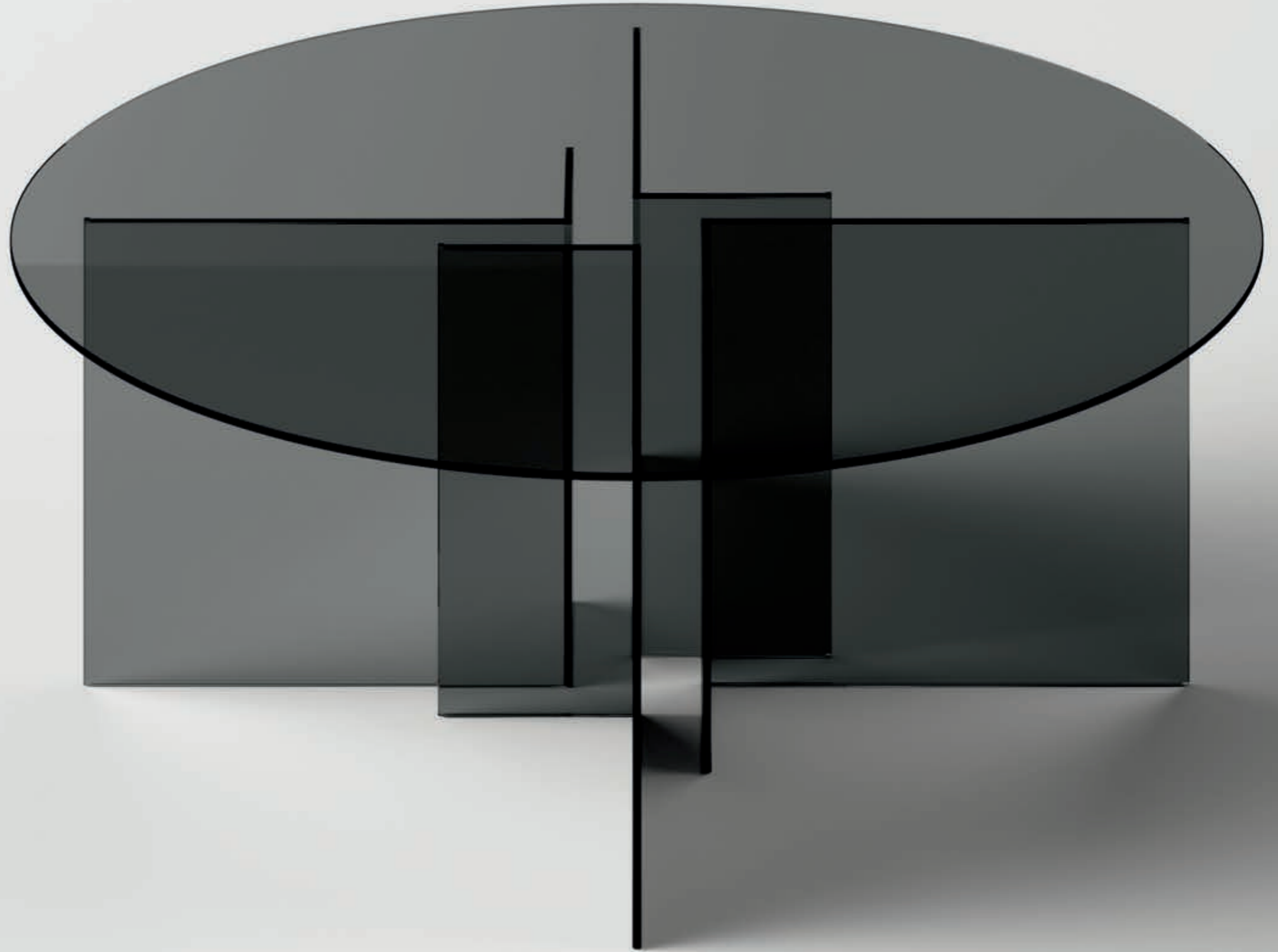

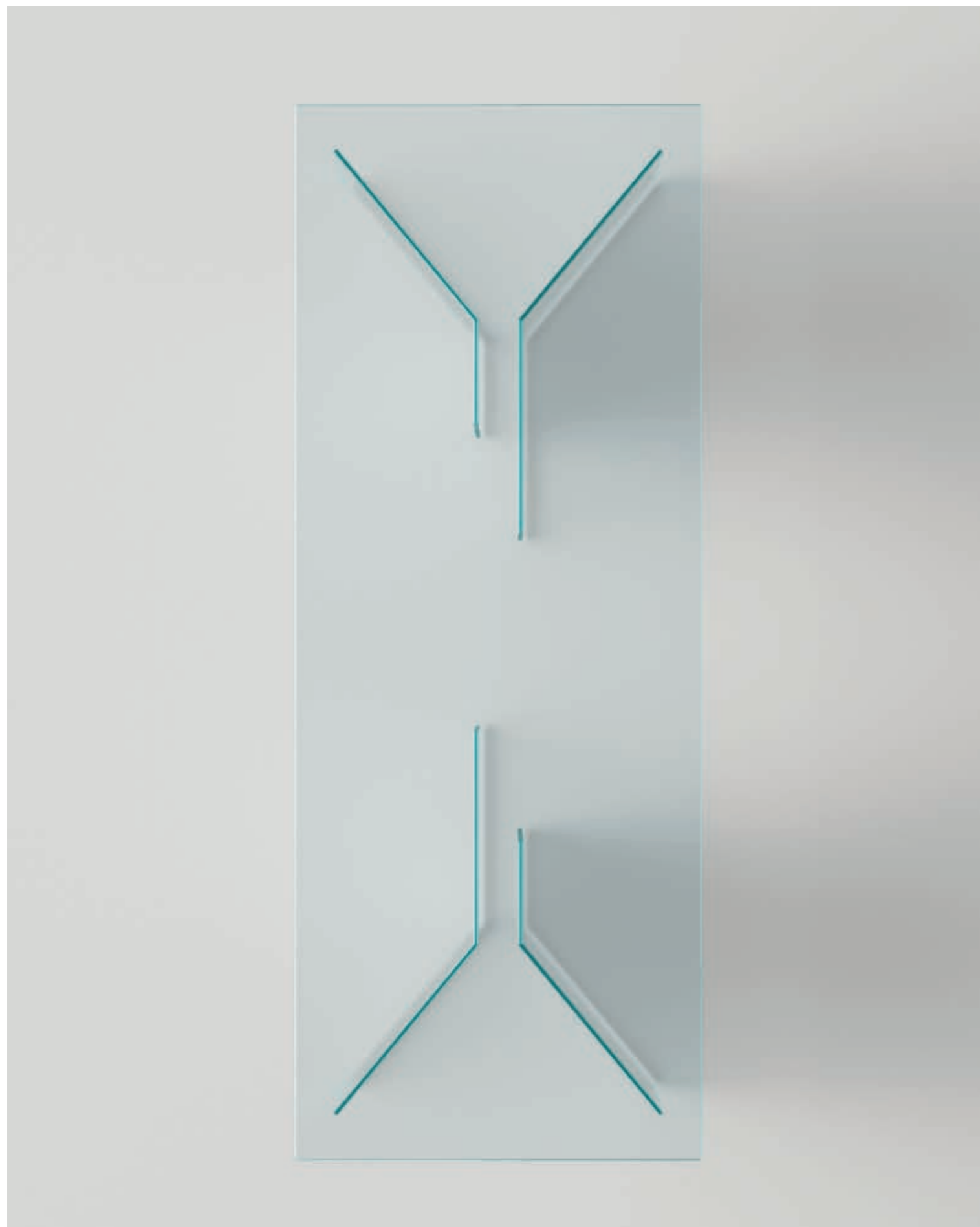

## Thrim fused glass Thrim dining tables

design  
**Massimo Castagna**

### INFO TECNICHE / TECHNICAL INFO

Tavolo con piano in appoggio in vetro extra chiaro, fumè o bronzo temperato, disponibile nelle forme tonde e rettangolari oppure rettangolari e quadrate sagomate. Piano disponibile anche nella versione vetro fuso fumè e bronzo nelle forme tonde e rettangolari sagomate. Basamento a elementi accostabili composto da parti in vetro extra chiaro, fumè o bronzo incollati tra loro.

Table with top in tempered extra clear, smoked or bronze glass, available in round and rectangular version or shaped round and rectangular version. Top also available in smoked and bronze fused glass for the shaped round and rectangular versions. Base composed of combining elements made of glued glass parts in extra clear, smoked or bronze.

**Piano / Top**  
200x100 / 220x100 / 240x100 / 260x100  
280x100 / 300x100 / 320x120

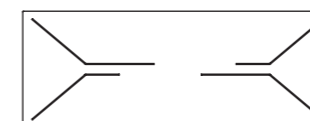

**Piano / Top**  
200x110 / 220x110 / 240x110 / 260x110  
280x110 / 300x110 / 320x120

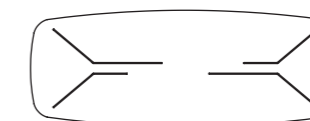

**Piano / Top**  
ø140 / ø160 / ø180 / ø200

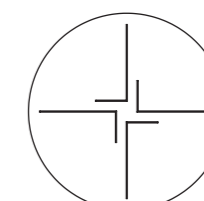

**Piano / Top**  
140x140 / 160x160  
180x180 / 200x200

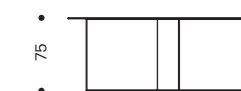
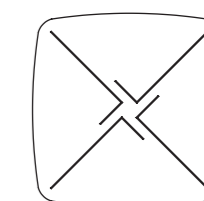

---

## Shoji Cabinet highboard

design  
**Studio Hosoe**  
**Lorenzo De Bartolomeis**

Cabinet con struttura in vetro e anta scorrevole in legno. Trova collocazione in diversi ambienti dal living alla zona notte, da una zona disimpegno all'ufficio. A seconda degli utilizzi è accessorabile con cassettiere in legno o asta appendiabiti.

Cabinet with glass structure and sliding door in wood. Can be used in different areas, from living rooms to bed rooms, entrances or offices. Depending on its use, it can be accessorized with chest of drawers or coat hanger rod.







## Shoji Cabinet highboard

design  
**Studio Hosoe**  
**Lorenzo De Bartolomeis**

### INFO TECNICHE / TECHNICAL INFO

Cabinet disponibile in due altezze in vetro extra-chiaro o fumé. Anta scorrevole in legno Siberian Ash o Eucalipto. Opzionale cassettiere in legno Siberian Ash, Eucalipto o laccato RAL opaco.

Cabinet available in two heights in extra clear or smoked glass. Sliding door in wood Siberian Ash or Eucalipto. Optional chest of drawers in wood Siberian Ash, Eucalipto or matt RAL lacquered.

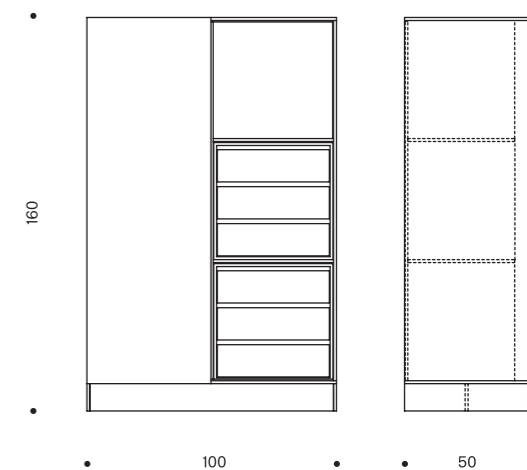
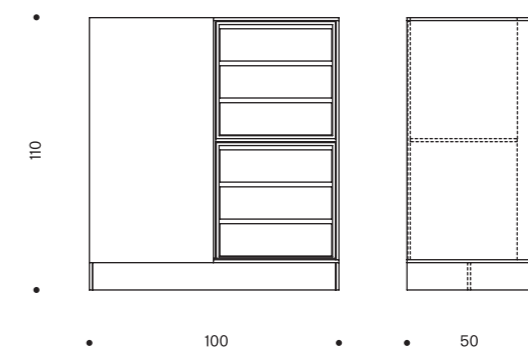



---

# SC010

**Metropolis XXL** Tavolo / Table  
Vetro fumè / Smoked glass

**She** Sedia / Chair  
Canna di fucile lucido, pelle marrone 5080  
Polished gunmetal, brown leather 5080

**Noum** Lampada / Lamp  
Siberian Ash

**Central** Specchio / Mirror



---

**Metropolis XXL**  
dining tables

design  
**Giuseppe Maurizio Scutellà**

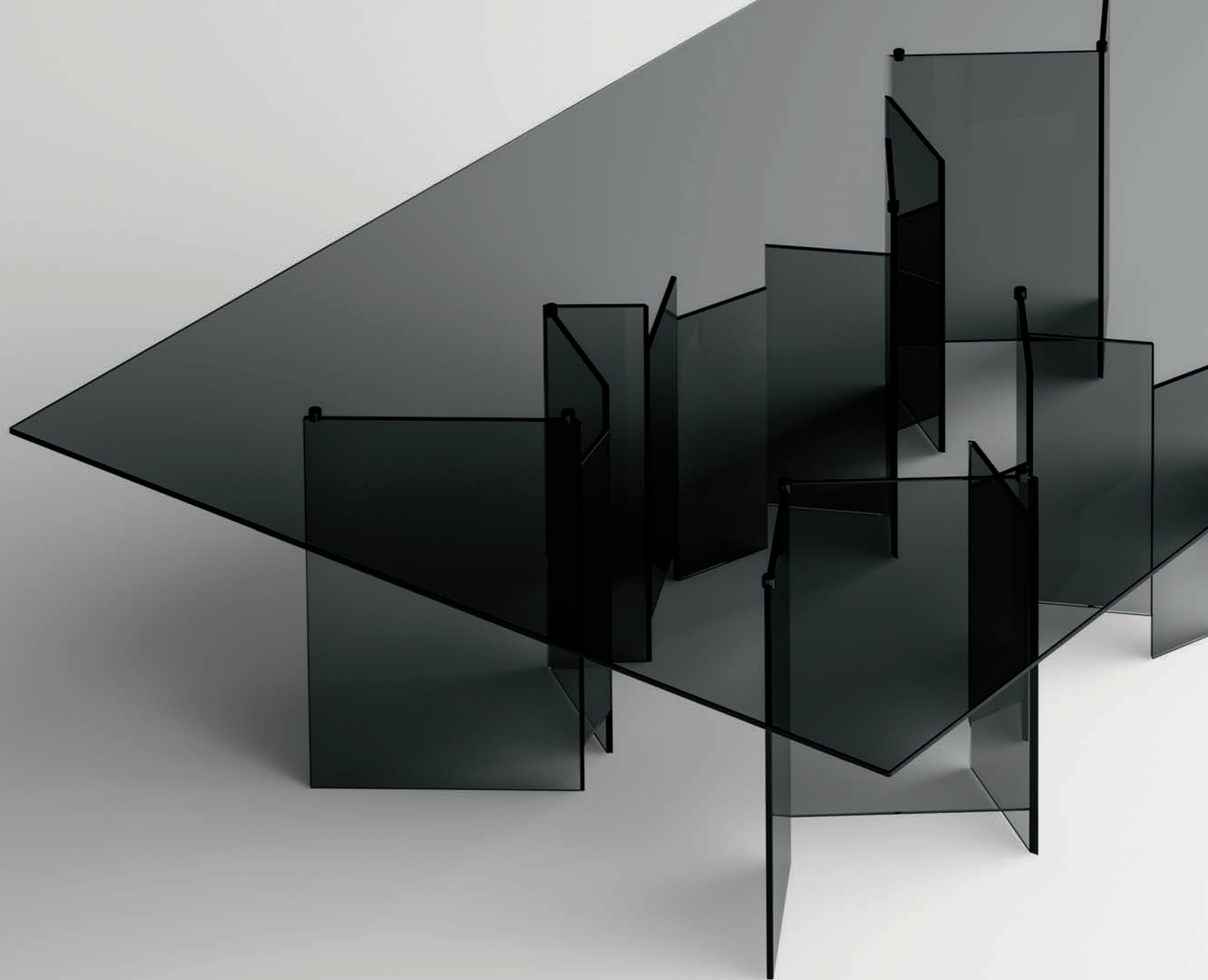



Il tavolo Metropolis XXL si aggiunge alla esistente collezione Metropolis. Essenziale ed eclettico, è protagonista degli ambienti casa e ufficio. Si adatta perfettamente ad ogni stile di interior, per la leggerezza del vetro e per la gamma di dimensioni disponibili.

The Metropolis XXL table widens the range of the existing Metropolis collection. Essential and eclectic, it is the main character of homes and offices. It can be perfectly adapted to any interior design style because of the lightness of the glass and the vast range of available dimensions.



Il piano di vetro disponibile di forma tonda e rettangolare, appoggia sulle basi caratterizzate da eleganti segni geometrici.

The glass top available in round or rectangular shape rests on the bases, characterised by an elegant geometric design.





## Metropolis XXL dining tables

design  
**Giuseppe Maurizio Scutellà**

### INFO TECNICHE / TECHNICAL INFO

Tavolo con piano di grandi dimensioni in appoggio, in vetro extra chiaro o fumè temperato. I basamenti, formati da più parti di vetro incollate assieme, vengono accostati per sorreggere i piani di svariate forme e dimensioni. I piani e i basamenti, in vetro extra chiaro e fumè, possono avere la stessa finitura oppure essere combinati tra di loro.

Table with big dimension top in tempered extra clear or smoked glass. The bases, made of several glass parts glued together, are placed next to each other so as to support tops of various forms and dimensions. Tops and bases, in extra clear or smoked glass, can have the same finish or a combination of the two.

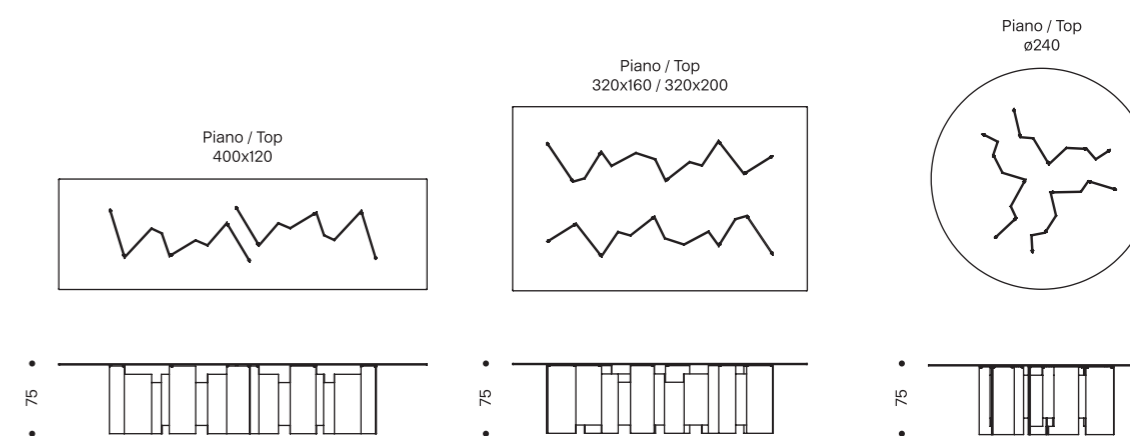

---

**Noum**  
lamp

design  
**Massimo Castagna**





Noum unisce la lavorazione artigianale del legno massello alla tecnologia dell'illuminazione. Il delicato segno grafico si enfatizza in installazioni a lampade multiple diventando assoluto protagonista dell'ambiente.

Noum joins the craftsmanship of solid wood with the lighting technology. The delicate graphic sign is enhanced by multiple lamps installations and thus becoming the absolute protagonist of the room.

La luce emessa illumina l'ambiente in modo caldo ed accogliente e disegna il tratto distintivo della struttura in legno dalla forma fluida e asimmetrica.

The light brightens the room warmly and pleasantly and outlines the distinctive trait of the wooden structure and its fluid and asymmetric shape.

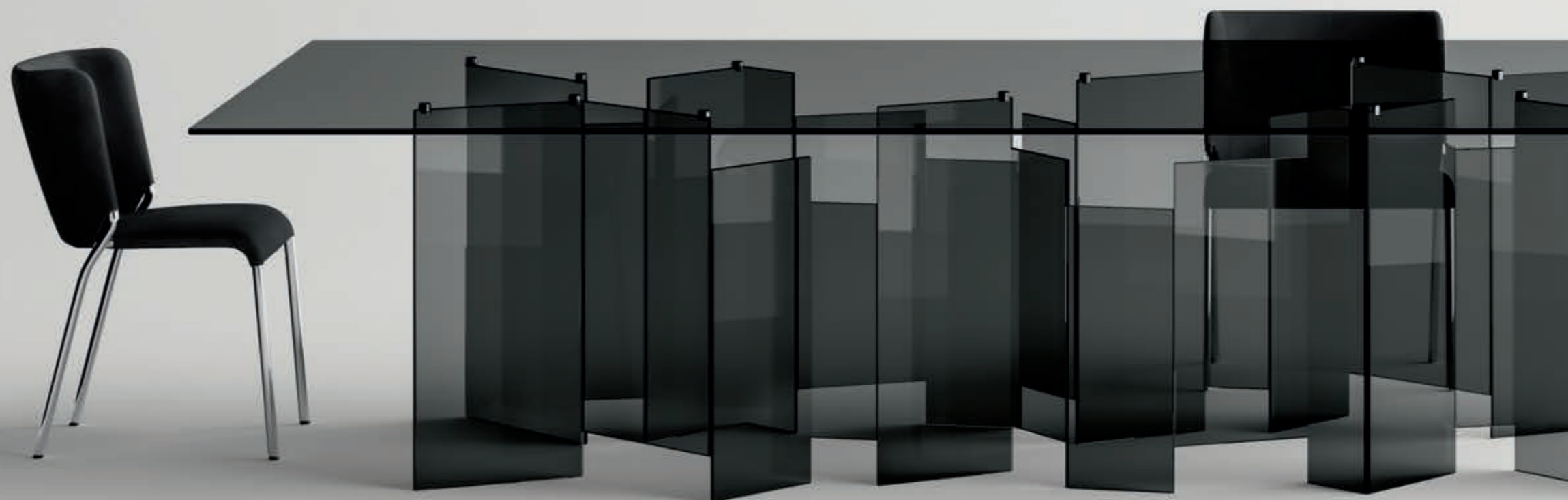



## Noum lamp

design  
**Massimo Castagna**

### INFO TECNICHE / TECHNICAL INFO

Collezione di lampade in legno massello in finitura Siberian Ash, Eucalipto o Rovere naturale. Disponibile nelle versioni ad uno o due elementi sospesi, con rosone unico a soffitto e cavo di sospensione nero regolabile in altezza. Versione sospesa libera con cavo di alimentazione nero con spina per presa elettrica. Impianto di illuminazione a luce LED COB 3000°K.

Collection of lamps in solid wood in Siberian Ash, Eucalipto or natural oak. Available with one or two hanging elements, with one ceiling rose and black suspension cable adjustable in height. Free hanging version with black power cable and electric plug. Lighting system with LED COB 3000°K.

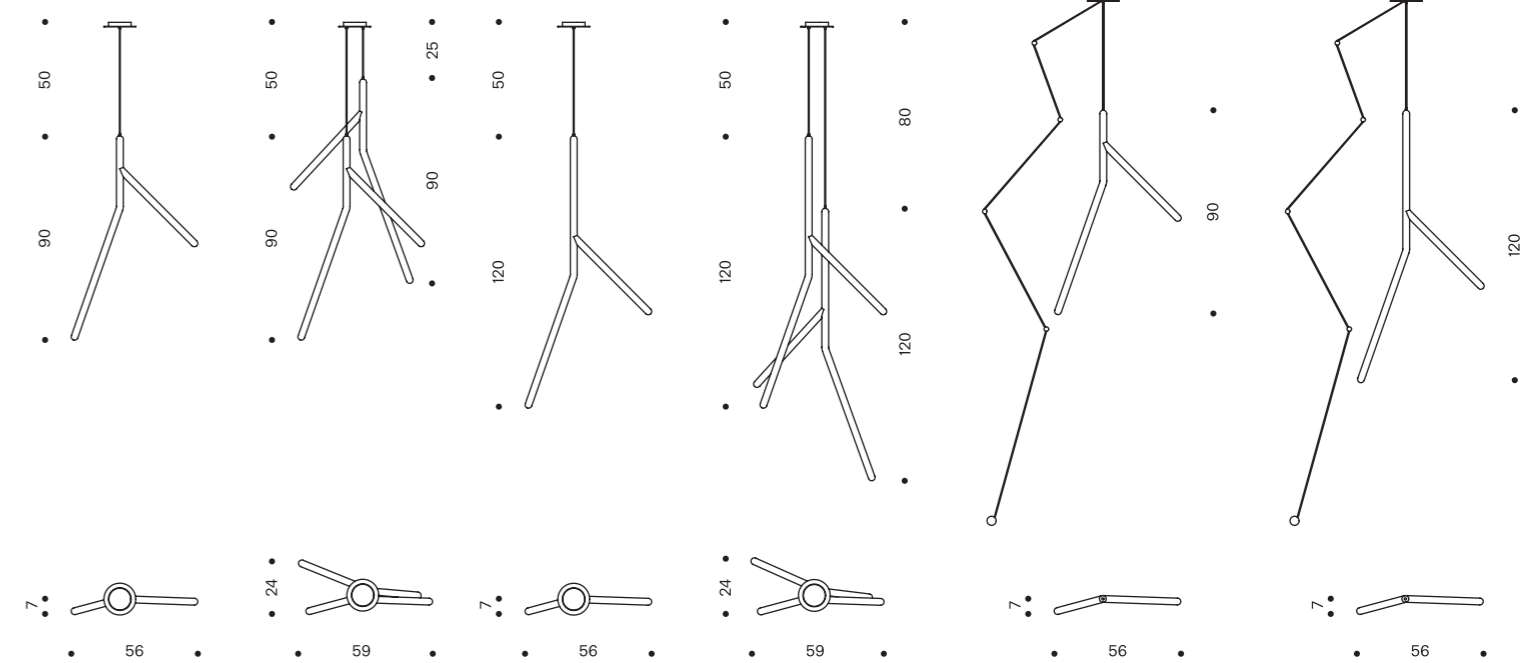

---

## Central mirror

design  
**Francesco Forcellini**

Specchio da parete di grandi dimensioni. Lo specchio centrale rotondo, dona un senso di tridimensionalità, mentre l'immagine riflessa risulta scomposta dai pannelli laterali leggermente inclinati.

Wall mirror of big dimensions. The central mirror is round, giving a sense of three-dimensionality, while the reflected image results broken up by the slightly inclined side panels.

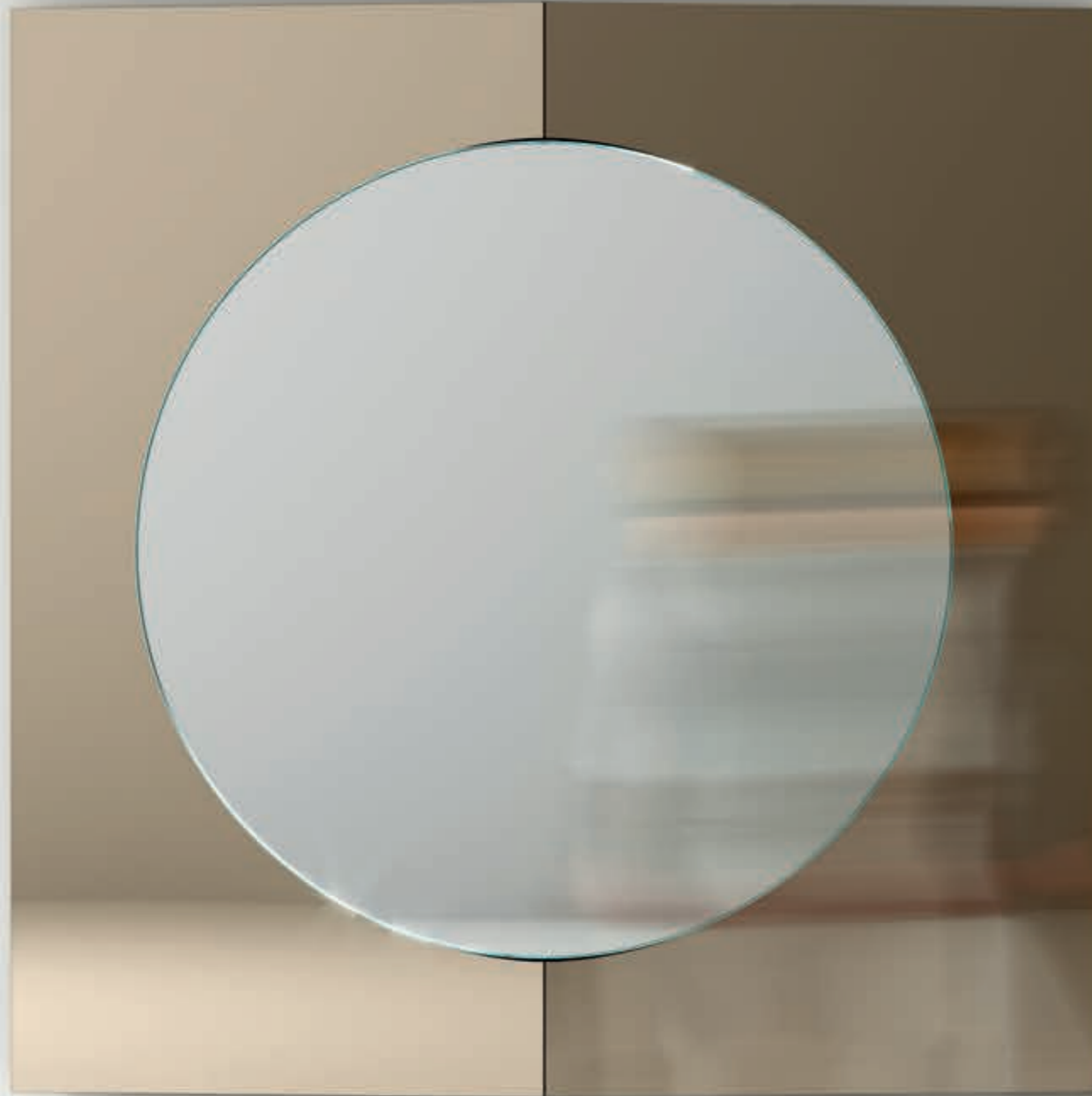







## Central mirror

design  
**Francesco Forcellini**

### INFO TECNICHE / TECHNICAL INFO

Specchio con struttura in legno formata da due pannelli laterali e un cerchio centrale. Le finiture dei tre pannelli sono disponibili in specchio, specchio oro, bronzo o fumé, abbinabili tra di loro.

Mirror with wooden structure made of two side panels and a central circle. The finishes of the three panels are available in mirror, gold, bronze or smoked mirror, that can also be combined with one another.

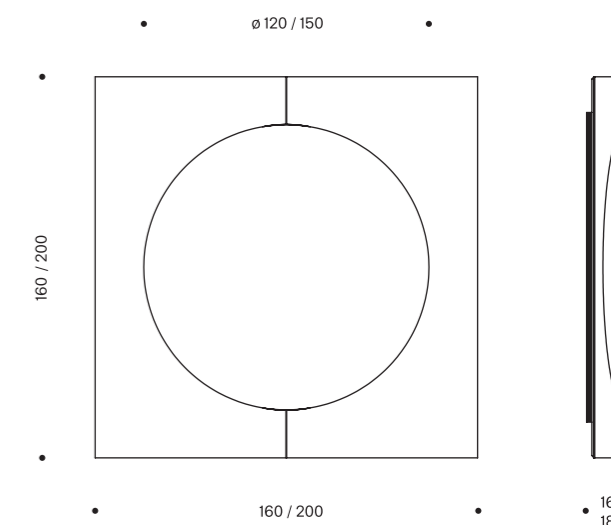



---

# SC011

**Perseo** Tavolo / Table

Vetro extra chiaro, gambe RAL 7016 Antracite  
Extra clear glass, RAL 7016 Anthracite legs

**She** Sedia / Chair

Canna di fucile lucido, pelle bianca 5000  
Polished gunmetal, white leather 5000

**Major** madia / sideboard

Siberian Ash, vetro fumè  
Siberian Ash, smoked glass

**Hyperion** Lampada / Lamp

Cromo lucido, vetro pyrex soffiato trasparente  
Polished chrome, transparent blown pyrex glass



---

**Perseo**  
dining tables

design  
Paolo Grasselli



Grande protagonista tra i nostri tavoli, Perseo ha sempre saputo valorizzare l'unione del vetro ad altri materiali favorendone la versatilità abitativa all'interno degli spazi. Nella sua eleganza si leggono tecniche costruttive complesse realizzate grazie alle abilità dei nostri artigiani.

Great protagonist among our tables, Perseo always knew how to enhance the combination of glass and other materials, thus gaining in versatility in its use. Complex construction techniques, obtained by the ability of our artisans, are to be seen in its elegance.

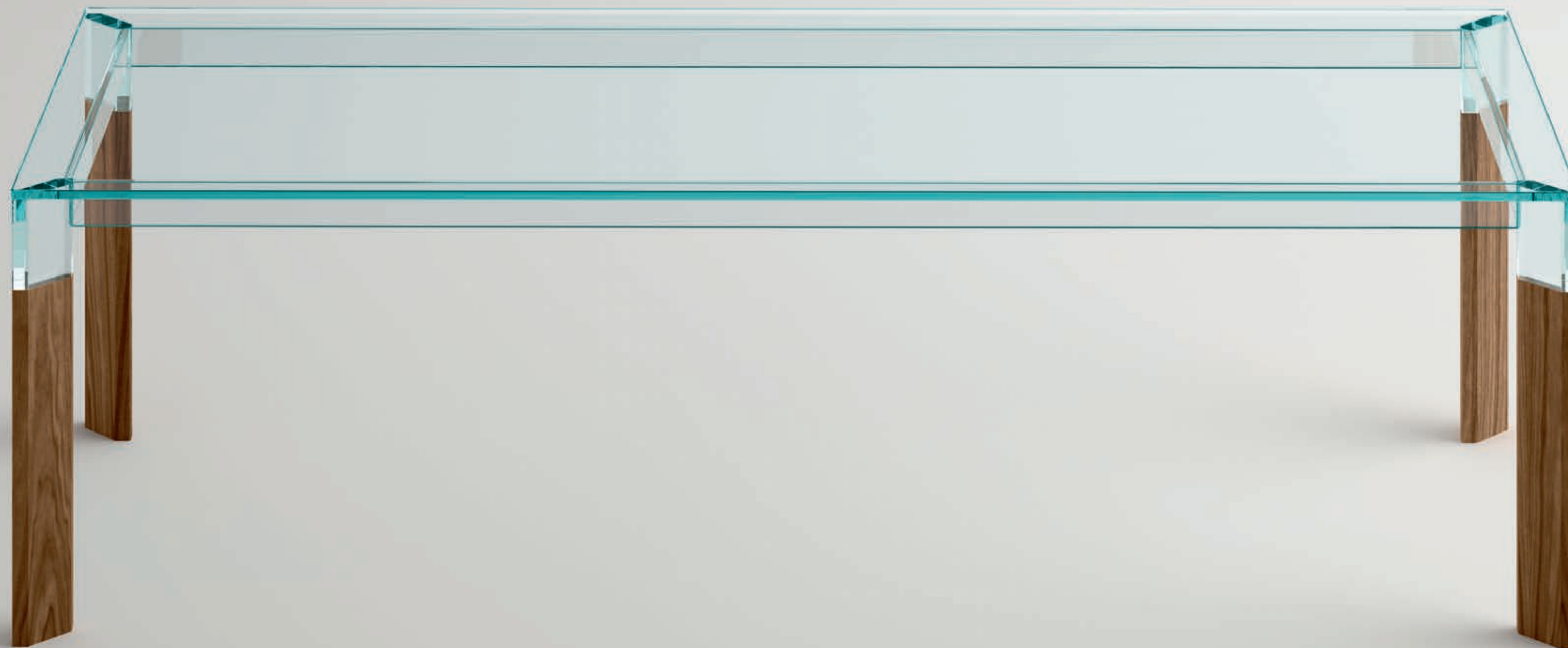

La vasta gamma di finiture legno e laccati opachi disponibile per le gambe, rendono Perseo un tavolo senza tempo e adatto a stili diversi.

The great range of wood and matt lacquered finishes for the legs make of Perseo a timeless table that adapts to different styles.





## Perseo dining tables

design  
**Paolo Grasselli**

### INFO TECNICHE / TECHNICAL INFO

Tavolo rettangolare o quadrato in vetro extra chiaro. Gambe smontabili in legno massello nelle finiture Noce Canaletto, Rovere Naturale, laccato bianco opaco o laccato RAL opaco.

Rectangular or square table in extra clear glass. Removable legs in solid walnut canaletto and natural oak, white matt lacquered or RAL matt lacquered.

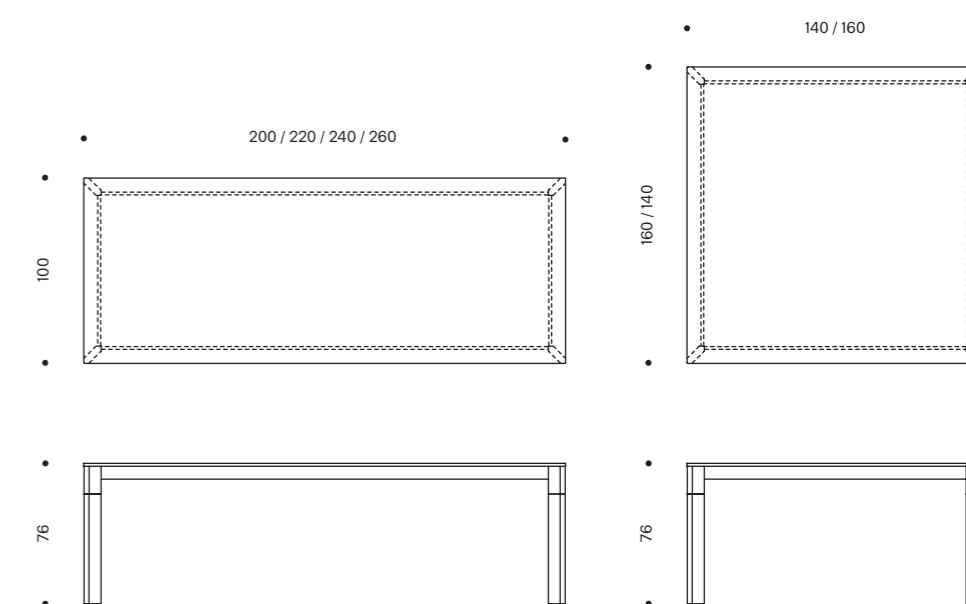



---

**Hyperion**  
lamp

design  
**Massimo Castagna**





Collezione di lampade di grande presenza scenica, caratterizzate da elementi in vetro dalla forma cubica arrotondata e struttura in metallo. Versione sospesa in due diverse configurazioni, chandelier con 5 vetri e verticale con 4 vetri. Sospensioni a vetro singolo di due diverse misure, lampada da terra nella configurazione verticale a 4 vetri.

Collection of lamps of great impact, made of glass elements with rounded cubic shape and structure in metal. Hanging version in two different configurations, chandelier with 5 glass cubes and vertical version with 4 glass cubes. Single hanging lamps in two different sizes, floor lamp in vertical configuration with 4 glass cubes.



La configurazione verticale, oltre che per l'utilizzo singolo su tavolo, è particolarmente adatta ad essere utilizzata in installazioni a lampade multiple, anche a differenti altezze.

The vertical configuration, apart from its single use on tables, is especially suitable to be used in installations of multiple lamps, also in different heights.





Le sospensioni singole, realizzate con le due diverse dimensioni dei vetri, sono elementi di grande pulizia formale. Utilizzabili sia per uso singolo, che per configurazioni multiple da installazione.

The single hanging lamps, made in two different glass sizes, have an extremely clean form. Can be used individually or also for multiple setups.



## Hyperion lamp

design  
**Massimo Castagna**

### INFO TECNICHE / TECHNICAL INFO

Collezione di lampade a sospensione e a terra. Luce LED G4 3000K. Lampadina dimmerabile. Cubi in vetro pyrex soffiato trasparente. Parti metalliche disponibili nelle finiture cromo lucido, oro lucido e canna di fucile lucido. L'altezza delle sospensioni può essere realizzata a misura, da un minimo di 110cm ad un massimo di 600cm totali.

Collection of hanging lamps and floor lamp. LED light G4 3000K. Dimmable bulb. Cubes in transparent blown Pyrex glass. Metal parts available in polished chrome, polished gold and polished gunmetal. Height of hanging lamps can be customized, from minimum 110cm to maximum 600cm total.

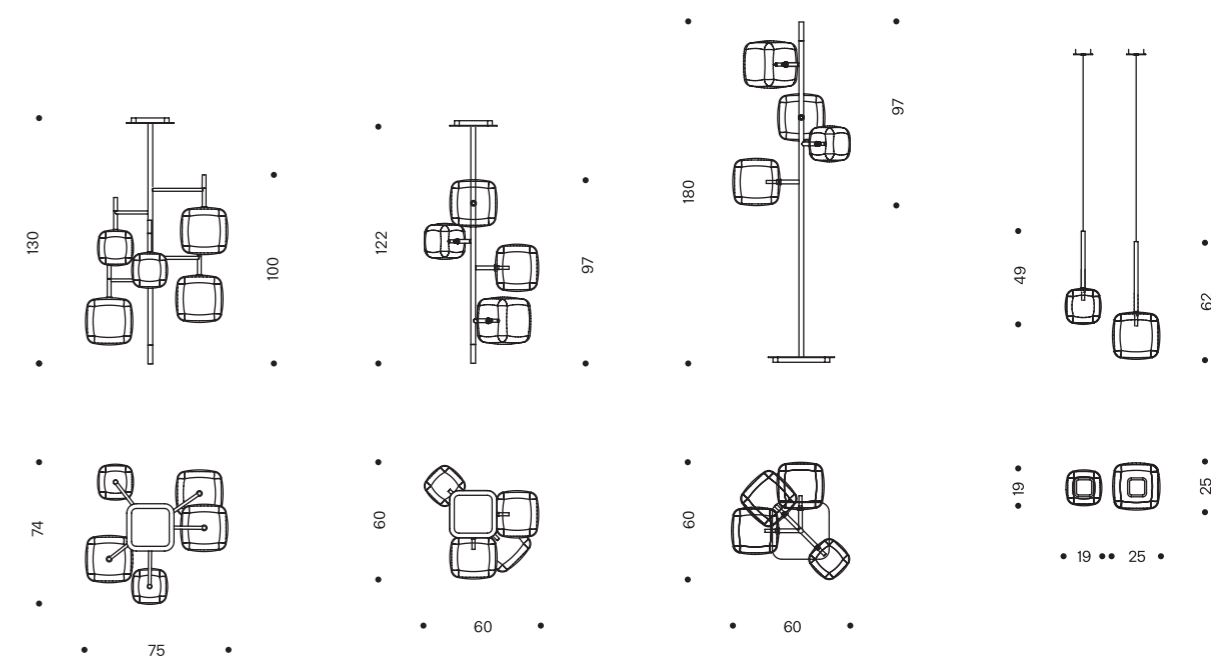



Ad arricchire la collezione di lampade, nuove versioni da tavolo di Hyperion realizzate con le due dimensioni dei vetri di forma cubica arrotondata. Utilizzabili sia per uso singolo che insieme abbinando le diverse altezze e larghezze.

The lamp collection Hyperion is enriched by the new table lamp versions with two dimensions of the rounded cube shaped glass. It can be used individually or combining the different heights and widths.

Elementi di grande pulizia formale che trovano collocazione all'interno dei vari ambienti della casa, dalla zona living alla zona notte fino allo studio.

Elements of very clean shapes that can be placed in several areas of a home, from the living area to the sleeping area or the office.







## Hyperion lamp

design  
**Massimo Castagna**

### INFO TECNICHE / TECHNICAL INFO

Collezione di lampade da tavolo. Luce LED G9 3000K. Lampadina dimmerabile. Cubi in vetro pyrex soffiato trasparente. Parti metalliche disponibili nelle finiture cromo lucido, oro lucido e canna di fucile lucido.

Collection of table lamps. LED light G9 3000K. Dimmable bulb. Cubes in transparent blown Pyrex glass. Metal parts available in polished chrome, polished gold and polished gunmetal.

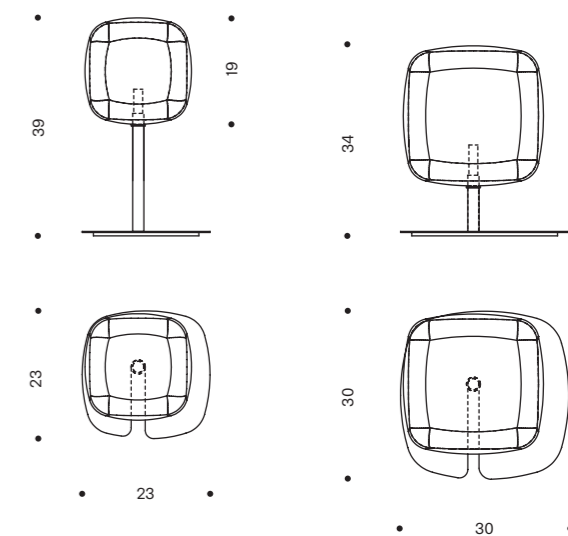



---

## SC012

**Marcell** Scrivania / Desk  
Vetro fumè, Siberian Ash  
Smoked glass, Siberian Ash

**She** Sedia / Chair  
Laccato nero opaco, ecopelle 1009  
Black matt lacquered, faux leather 1009

**Hemingway** Libreria / Bookcase  
Siberian Ash, inserti cromo lucido, vetro extrachiario  
Siberian Ash, polished chrome inserts,  
extra clear glass

**Hyperion** Lampada / Lamp  
Canna di fucile lucido, vetro pyrex soffiato trasparente  
Polished gunmetal, transparent blown pyrex glass



---

**Marcell**  
console / desk  
dressing table

design  
**Massimo Castagna**

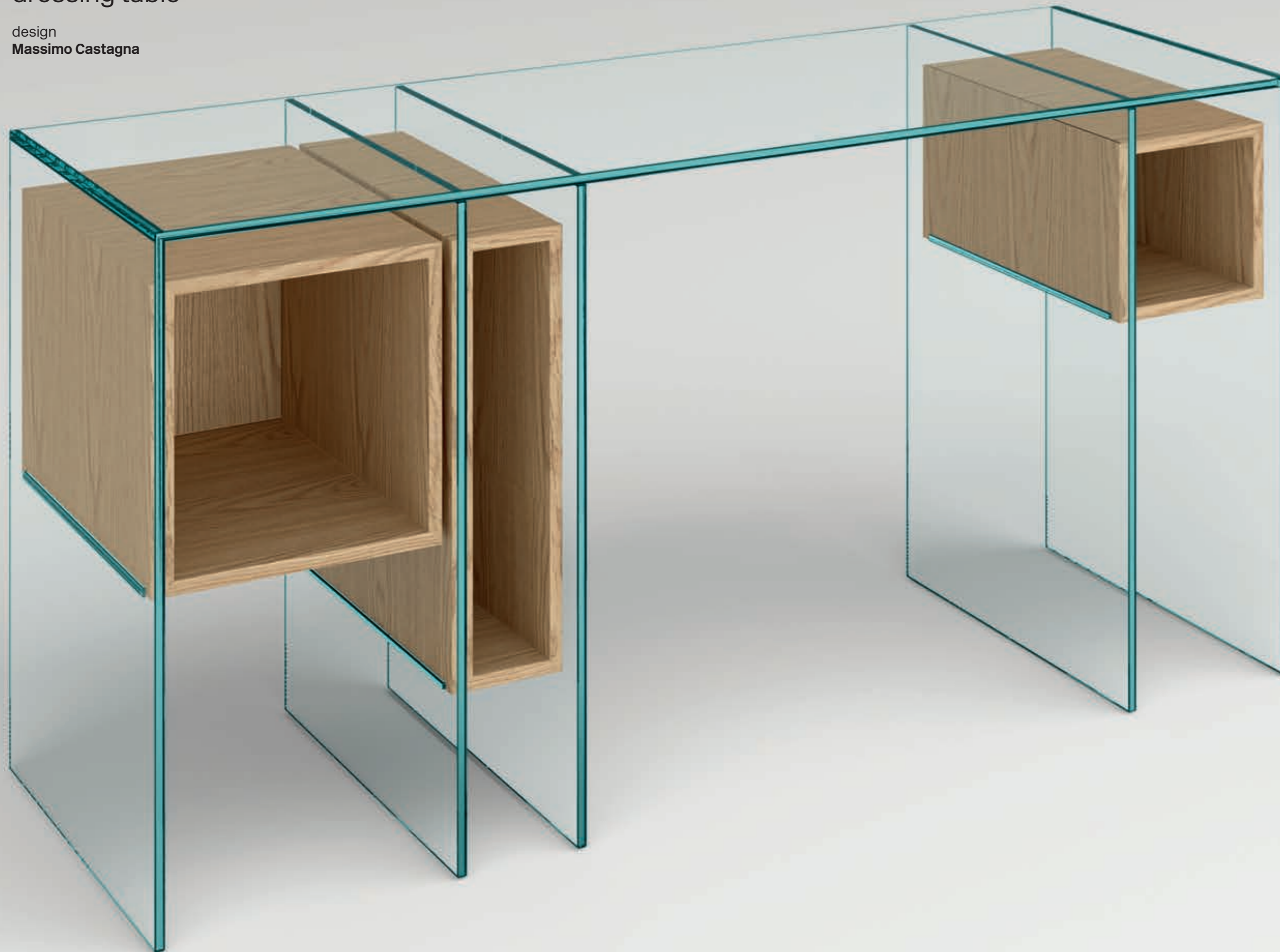

Marcell rappresenta un classico senza tempo, definito dalle linee essenziali e rigorose del vetro e dal calore e matericità del legno.

Marcell represents a timeless classic, defined by the essential and rigorous lines of the glass and the warmth and texture of the wood.



Grande versatilità d'uso nei diversi ambienti, Marcell nasce come scrittoio ma trova collocazione anche come consolle nell'ingresso e, se attrezzato con cassetti portaoggetti e specchio da appoggio, come dressing table diventando protagonista nella zona notte.

Great versatility for its use in different areas, Marcell is born as a desk but finds its place also as an entry console and, if equipped with glove box drawers and countertop mirror, as a dressing table, thus becoming the protagonist of the night area.

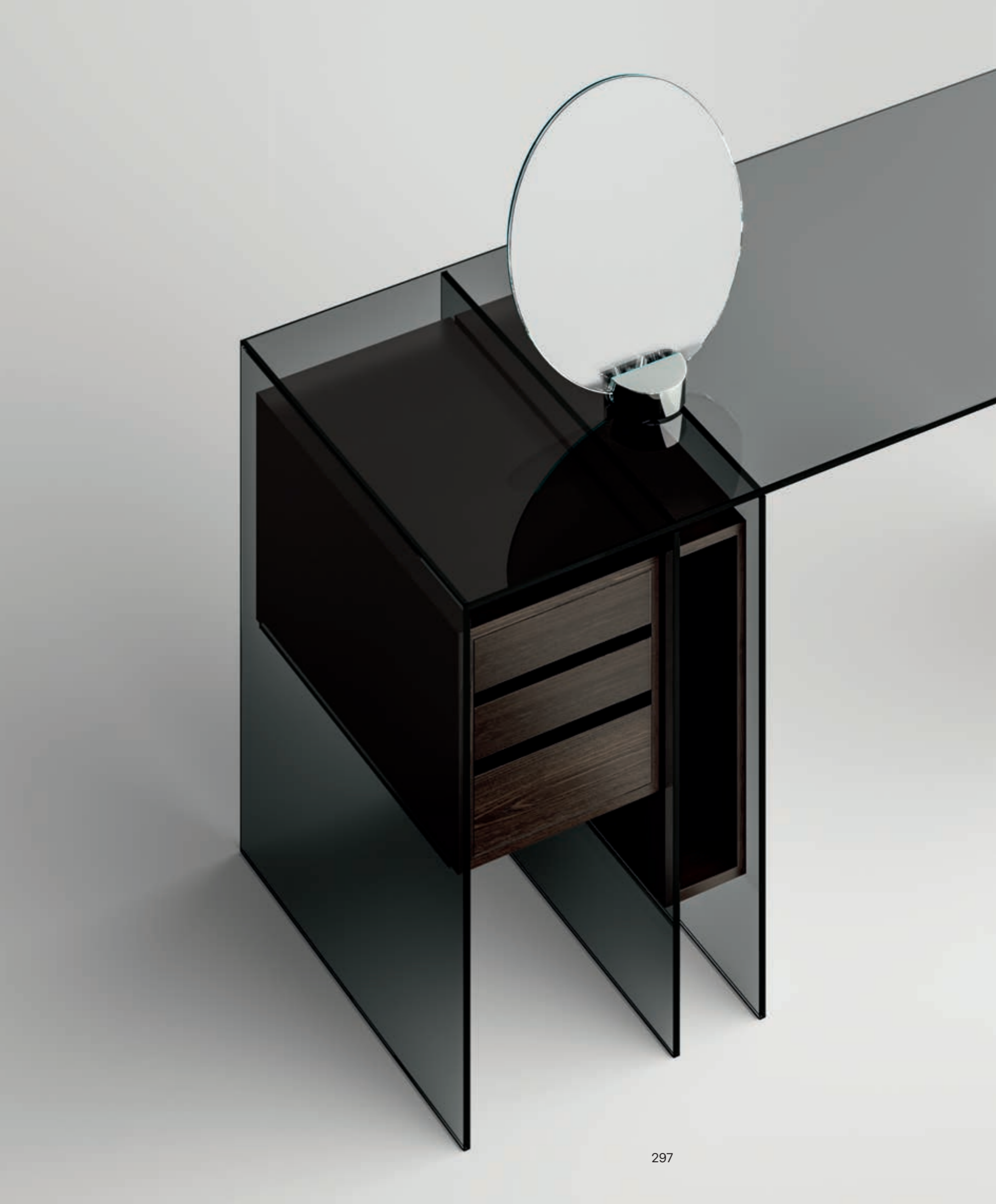



## Marcell console / desk dressing table

design  
**Massimo Castagna**

### INFO TECNICHE / TECHNICAL INFO

Consolle, scrittoio o dressing table con struttura incollata in vetro extra chiaro o fumè e contenitori in legno in finitura Eucalipto, Siberian Ash o Rovere Naturale. Sono optional l'anta battente SX o il set 3 cassetti in finitura abbinata. Lo scrittoio può essere completato con lo specchio in appoggio della stessa collezione con base in metallo cromato lucido.

Console, desk or dressing table with structure in glued glass extra clear or smoked and wooden storage units in Eucalipto, Siberian Ash or Natural Oak. Optional hinge door left or set of 3 drawers in matching finish. The desk can be completed with the countertop mirror of the same collection with polished chrome metal base.

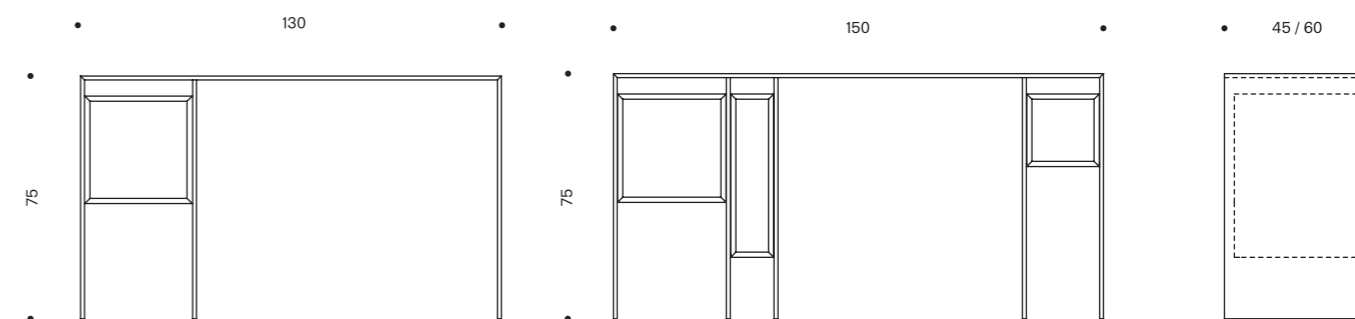





---

## SC013

**Crossover** Tavolo / Table  
Vetro fumè, canna di fucile  
Smoked glass, polished gunmetal

**She** Sedia / Chair  
Cromo lucido, pelle marrone scuro 5400  
Polished chrome, dark brown leather 5400

**Major** madia / sideboard  
Siberian Ash, vetro fumè  
Siberian Ash, smoked glass

**Hyperion** Lampada / Lamp  
Oro lucido, vetro pyrex soffiato trasparente  
Polished gold, transparent blown pyrex glass



---

## Crossover dining tables

design  
**Massimo Castagna**

Una struttura scultorea ed elegante per il nuovo tavolo disegnato da Massimo Castagna. Capacità nel combinare materiali di diversa natura insieme alla straordinaria passione per la lavorazione del vetro permettono di modellare le forme e gli spessori fino a definire un'immagine di forza e di carattere.

A sculptural and elegant structure for the new table designed by Massimo Castagna. The ability to combine materials of different nature together with the extraordinary passion for glass processing allow to shape forms and thicknesses up until an image of great force and character is defined.

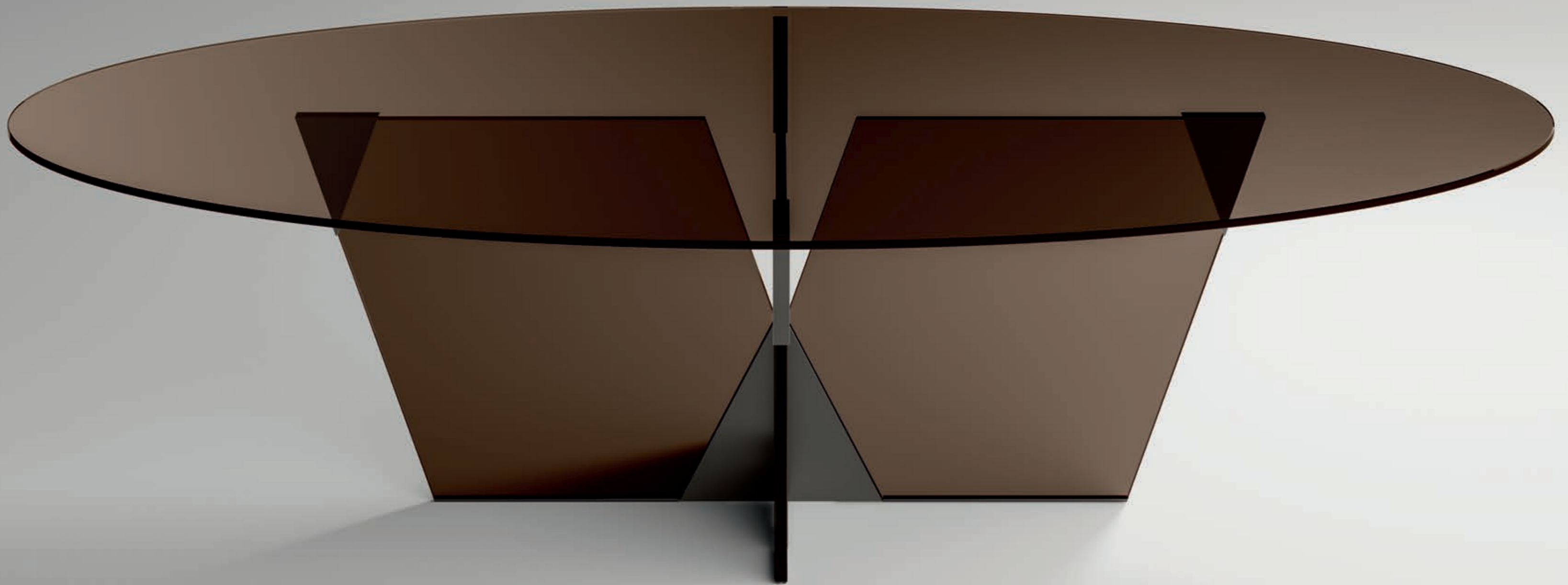

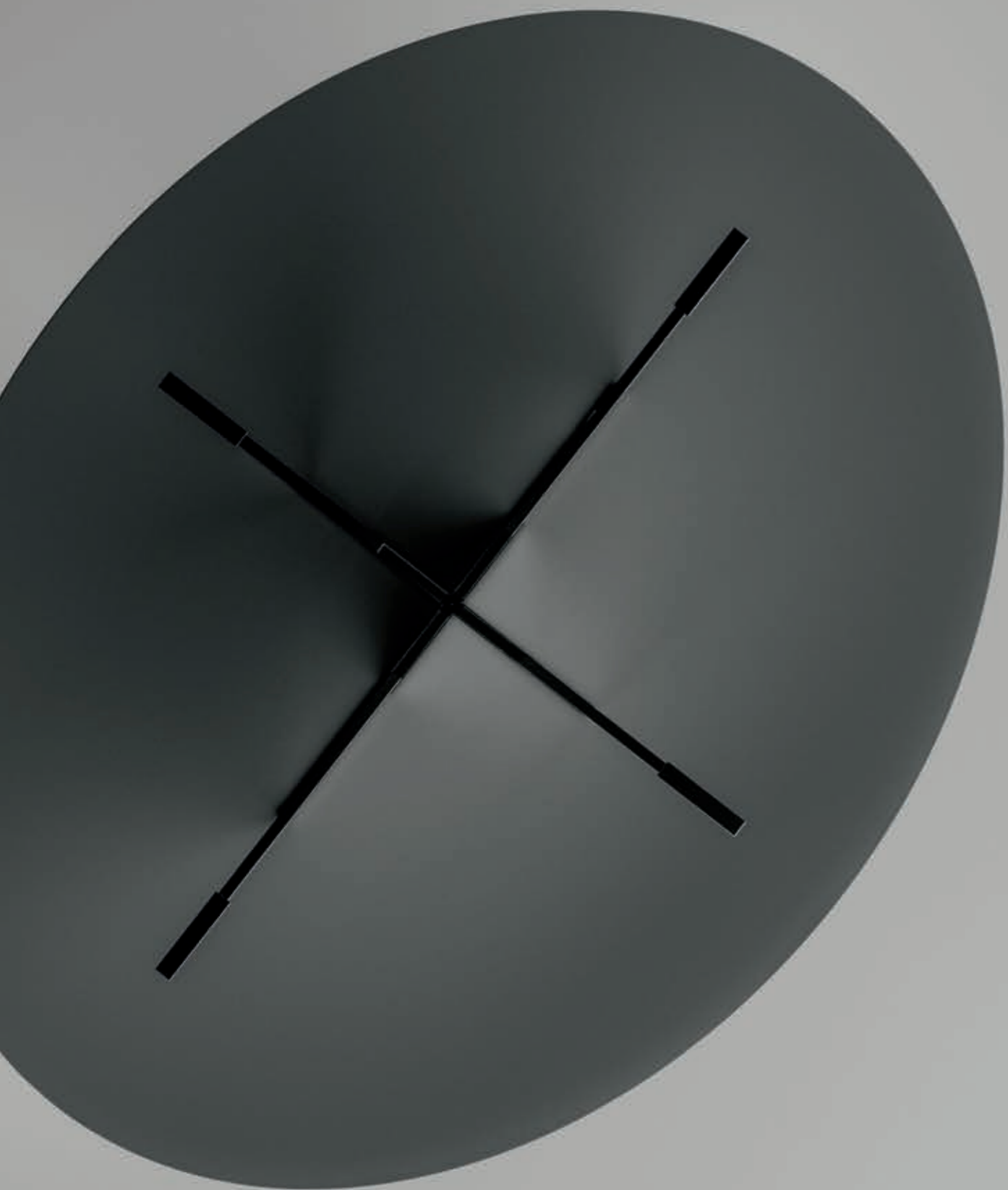

La base architettonica in vetro di forte spessore, caratterizzata da un giunto centrale piramidale in metallo, costituisce la parte essenziale di questo tavolo. I dettagli in metallo danno forma ai vetri della base donandole carattere e originalità.

The architectonic glass base of great thickness features a pyramidal central metal joint which constitutes the main part of this table. The metal details shape the glasses of the base conferring character and originality.

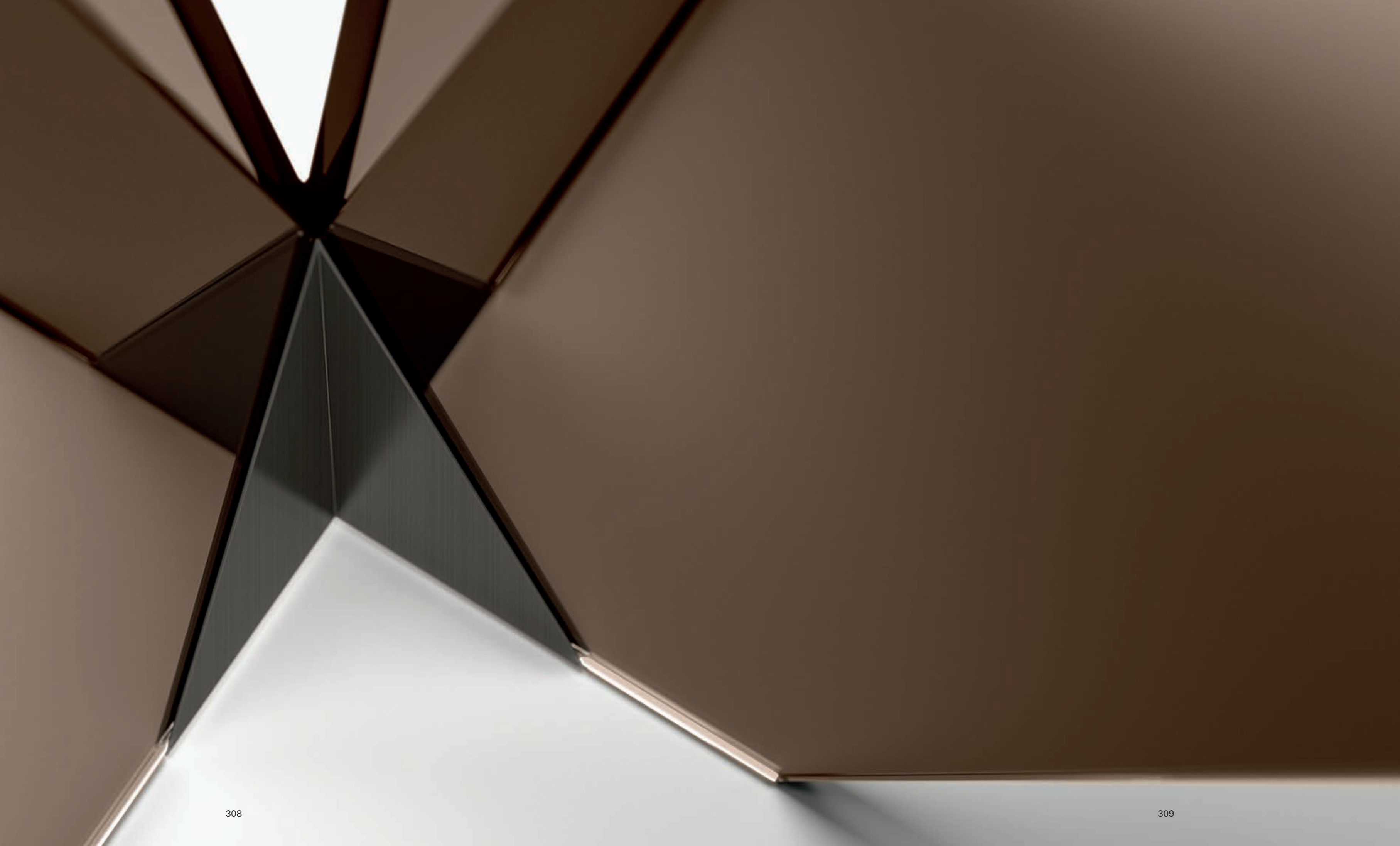

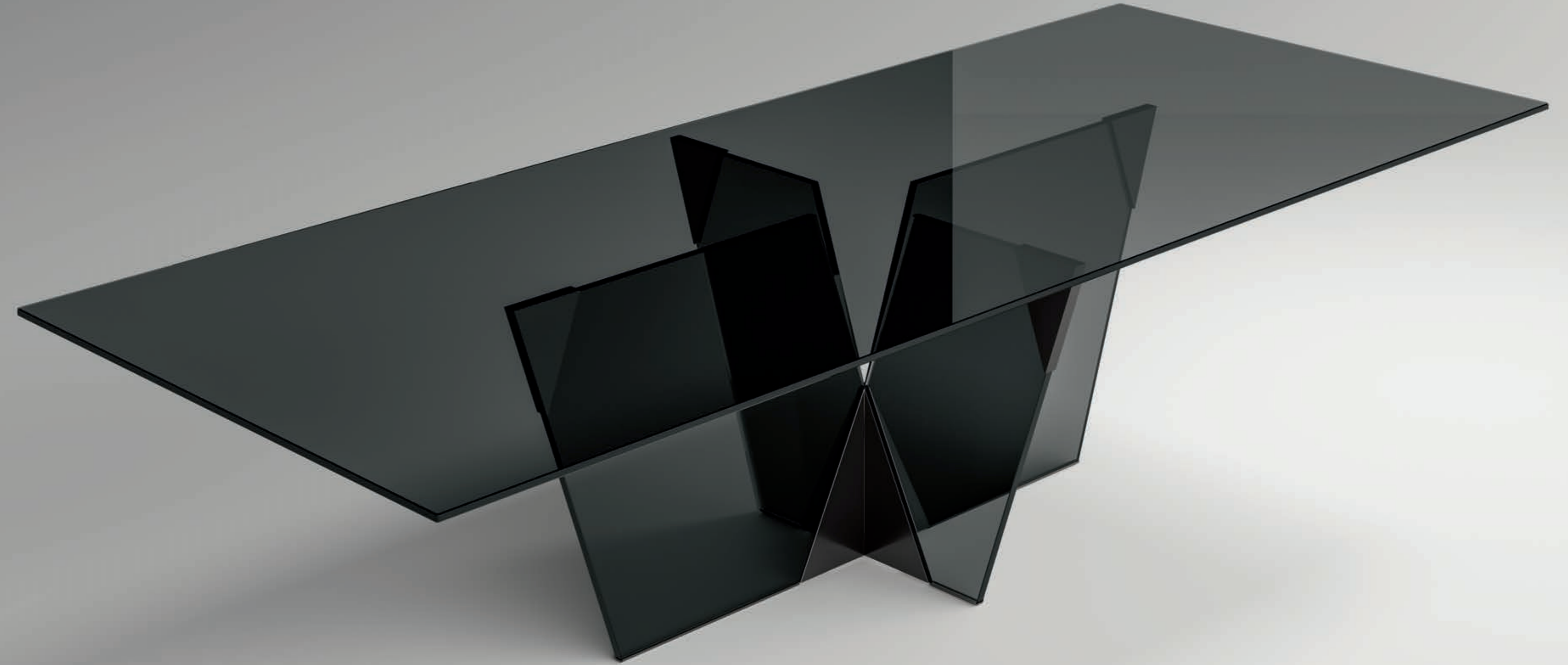



## Crossover dining tables

design  
Massimo Castagna

### INFO TECNICHE / TECHNICAL INFO

Tavolo con basamento centrale in vetro extra chiaro, fumè o bronzo stratificato in spessore 10+10mm. Giunto centrale e supporti del piano in metallo finitura canna di fucile lucido o Titanio spazzolato opaco. La base è completamente smontabile e il piano è in appoggio con piastre metalliche per il centraggio. Piano in vetro extra chiaro temperato spessore 15mm oppure in vetro fumè o bronzo stratificato in spessore 10+6mm.

Table with base in extra clear, smoked or bronze stratified glass 10+10mm. Central joint and top supports in metal in polished gunmetal or matt brushed Titanium finish. The base is completely demountable and the table top rests on the base with metal plates for the centring. Table top in extra clear tempered glass of 15mm or in stratified smoked or bronze glass in 10+6mm.

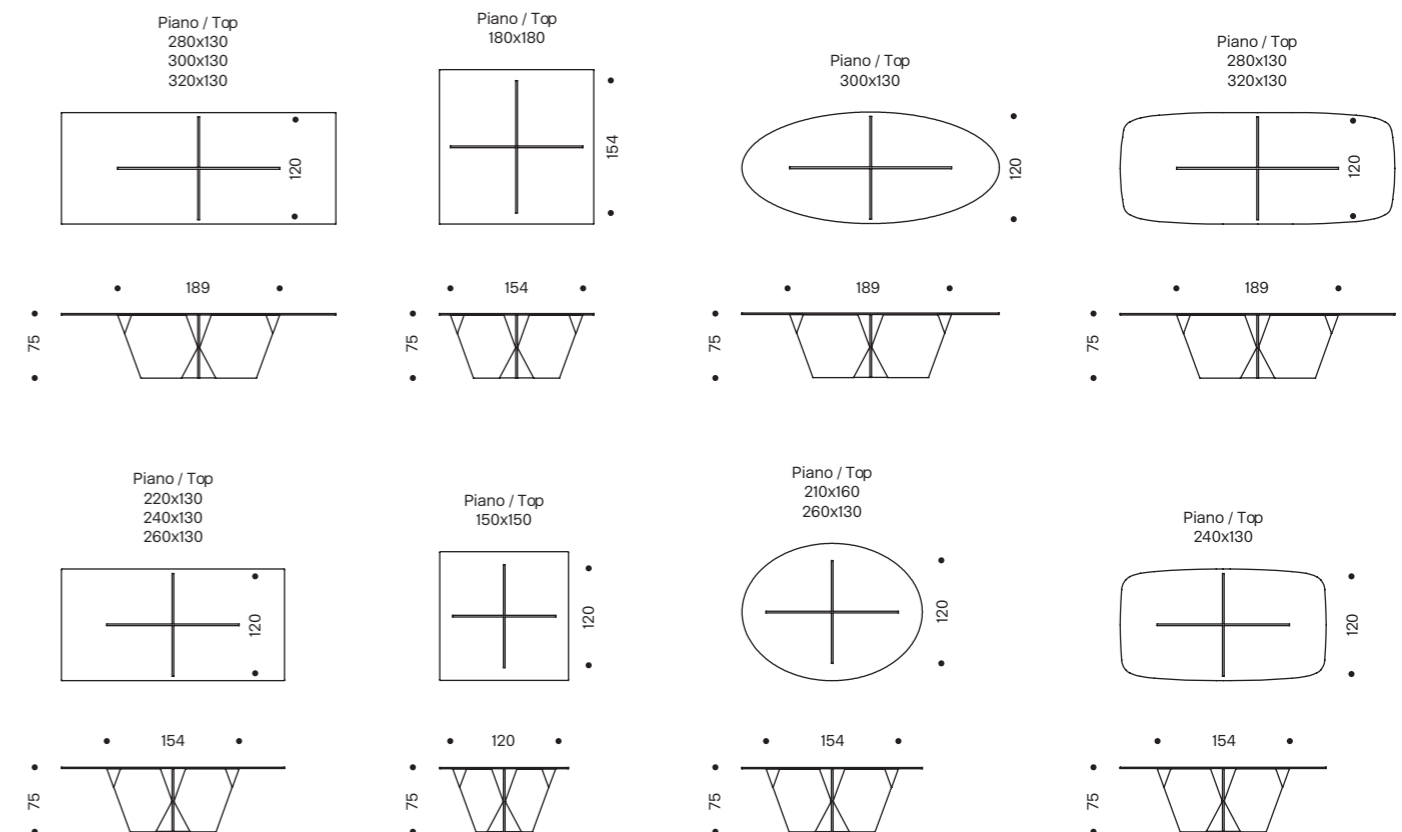

---

## Major sideboard

design  
**Bellavista & Piccini**

Un mobile contenitore caratterizzato dalla struttura in vetro e dai frontali in essenza. Major offre composizioni pensate per i diversi usi e le diverse aree della casa, personalizzabili e variabili in base agli stili e ai gusti.

Sideboard featuring a glass structure and frontal parts in wood. Major offers compositions thought for different uses and different home areas, adaptable and changeable according to personal style and taste.

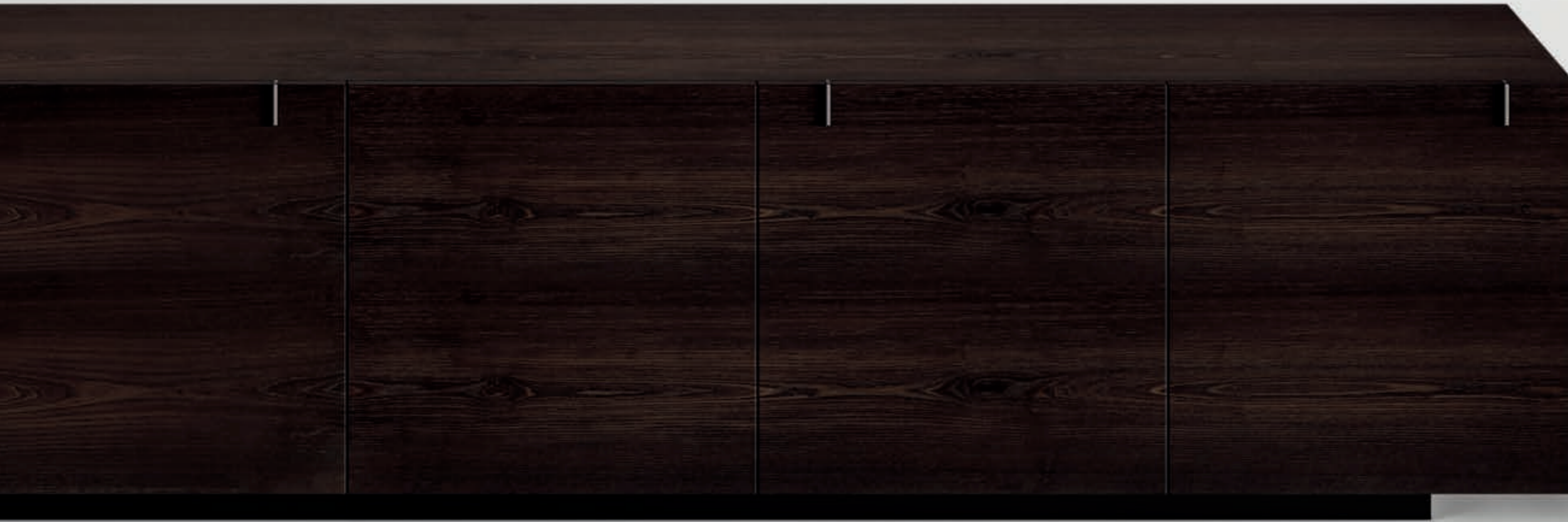



Le ante sono dotate di una sottile maniglia che, oltre a rappresentare un elegante dettaglio di design, integra il sistema magnetico di apertura e blocco.

The doors are equipped with a slim handle, an elegant design detail that completes the magnetic system of opening and halting.



La madia Major offre un sistema di apertura delle ante unico e innovativo. La combinazione di ante scorrevoli e battenti, permette alla madia di apparire sempre diversa e di essere utilizzata secondo le proprie esigenze.

Sideboard Major offers a unique and innovative door opening system. The combination of sliding and hinge doors allows the sideboard to always show different aspects and to be used according to one's necessities.



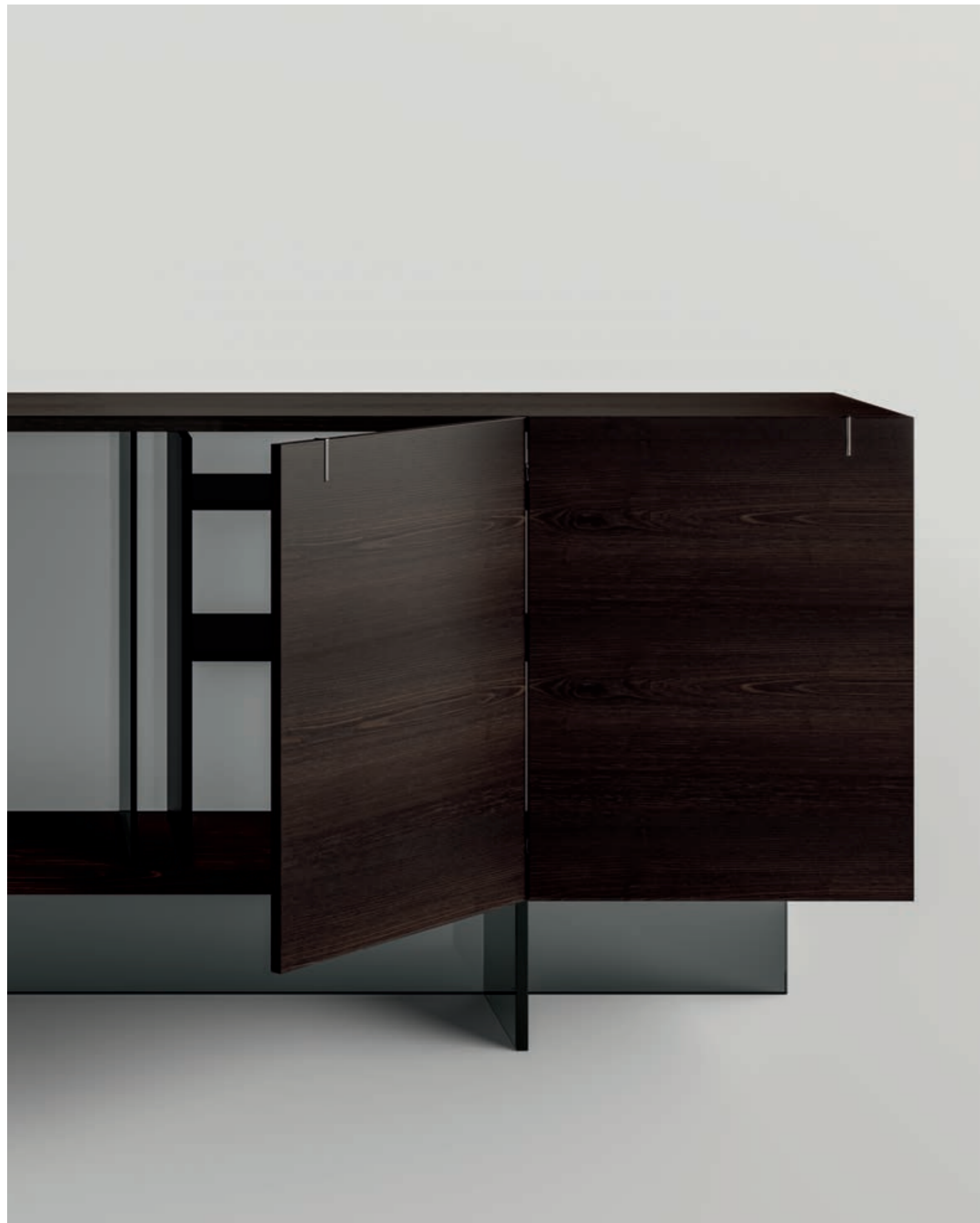

## Major sideboard

design  
Bellavista & Piccini

### INFO TECNICHE / TECHNICAL INFO

Madia composta da top, fondo e ante in legno a vena continua nelle finiture Eucalipto o Siberian Ash. Struttura verticale composta da fianchi, schiena e fianchi interni in vetro nelle versioni fumè o bronzo. Basamento in vetro extra chiaro spessore 19 mm oppure vetro fumè o bronzo stratificato spessore 10+10 mm. In alternativa, zoccolo in legno verniciato nero opaco con regolazione integrata. L'interno può essere personalizzato con comodi elementi divisori in legno laccato nero.

Sideboard made of top, bottom and doors in wood with continuous vein in Eucalipto and Siberian Ash finish. Vertical structure made of sides, back and internal partition in glass in smoked or bronze finish. Base in extra clear glass 19mm thick or stratified bronze or smoked glass 10+10mm. In alternative it can be with black lacquered wooden plinth with integrated regulation. The inside can be personalized with dividing elements in black lacquered wood.

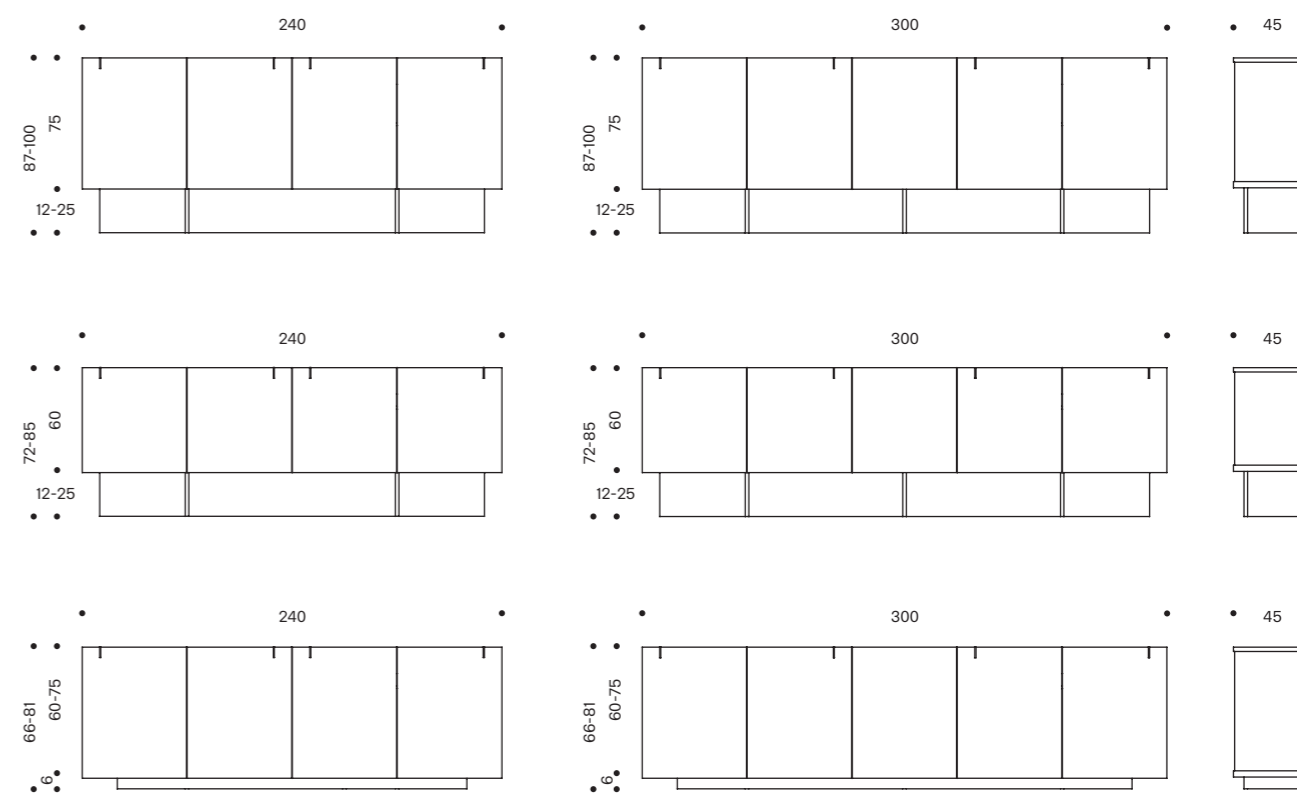



---

# SC014

**Thrim** Tavolo / Table  
Vetro fumè / Smoked glass

**She** Sedia / Chair  
Canna di fucile lucido, pelle marrone scuro 5400  
Polished gunmetal, dark brown leather 5400

**Hemingway** Libreria / Bookcase  
Siberian Ash, inserti cromo lucido, vetro extra  
chiaro. / Siberian Ash, polished chrome inserts,  
extra clear glass

**Hyperion** Lampada / Lamp  
Cromo lucido, vetro pyrex soffiato trasparente  
Polished chrome, transparent blown pyrex glass

**Whirl** Specchio / Mirror



---

## Hemingway bookcase

design  
**Massimo Castagna**

Libreria con struttura in legno massello, composta da montanti e traversi, per fissaggio a muro o a soffitto. I montanti sono alleggeriti da fessure frontali e laterali e caratterizzati da inserti in metallo lucido.

Bookcase with solid wood structure, made of uprights and beams, wall or ceiling fixing. The uprights are made lighter by frontal and lateral slots and are characterized by inserts in polished metal.

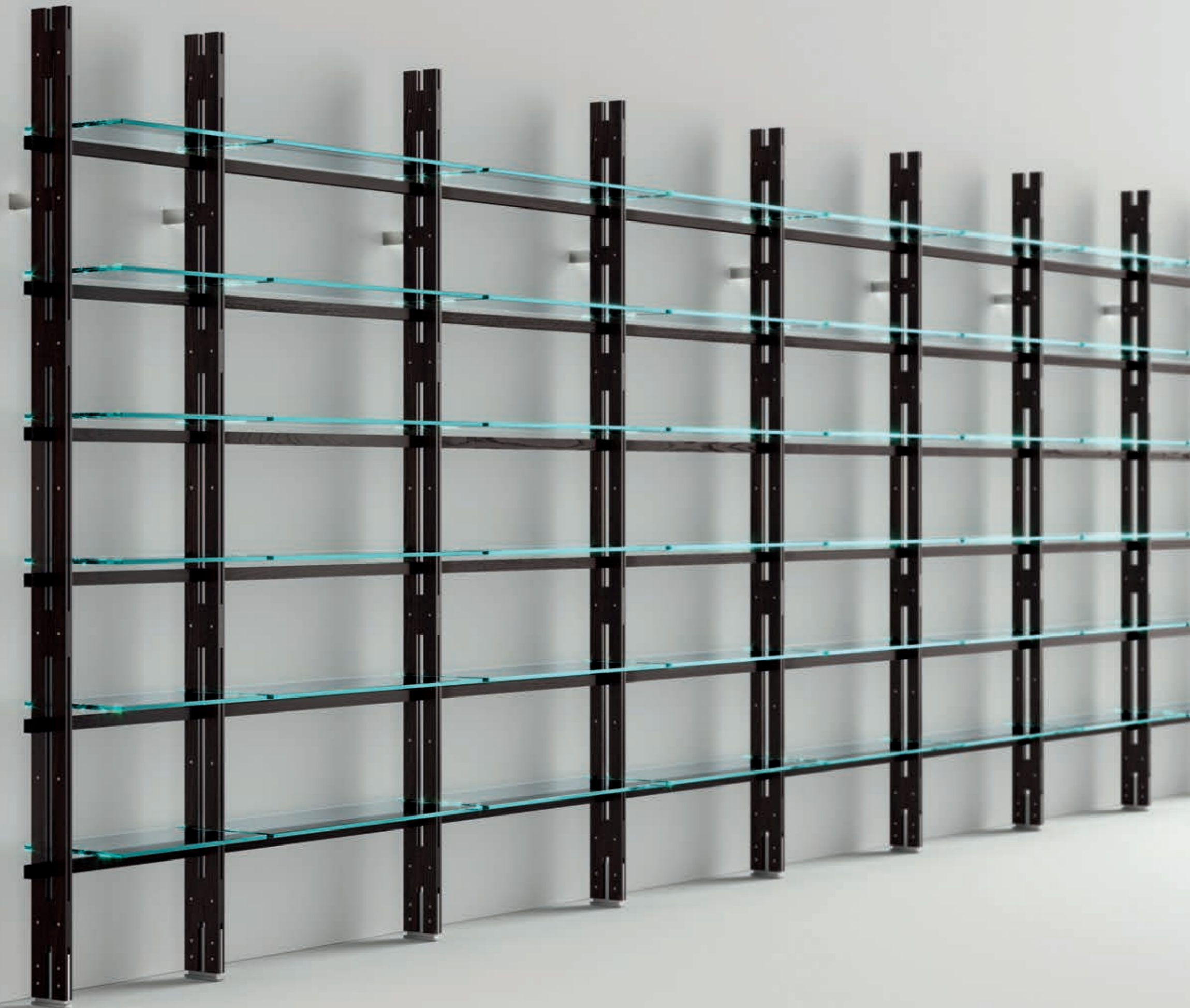

I traversi orizzontali ne definiscono fisicamente e visivamente la forma e la metrica. La struttura sostiene i ripiani ed i contenitori nelle varie funzioni e dimensioni.

The horizontal beams physically and visually define its form and metrics. The structure supports the shelves and storage units allowing various functions and dimensions.





I ripiani in vetro, con particolari asole laterali, sono fissati ai montanti tramite incastro sui perni. Un sistema di sicurezza anticaduta è presente su ogni ripiano.

The glass shelves, with peculiar lateral slots, are fixed to the uprights by an interlocking system on pins. A fall arrest security system is included with each shelf.

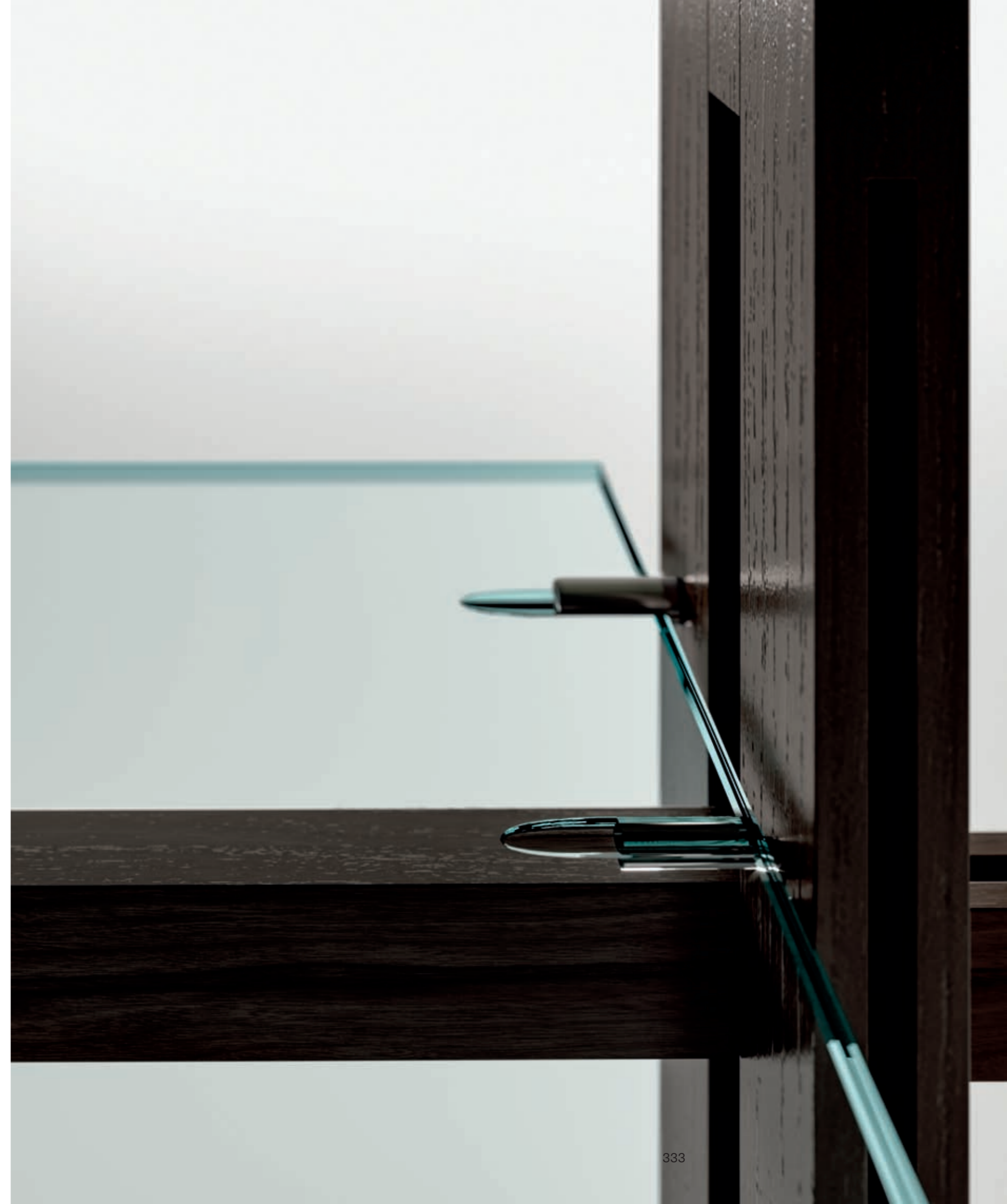





## Hemingway bookcase

design  
**Massimo Castagna**

### INFO TECNICHE / TECHNICAL INFO

Montanti verticali e traversi orizzontali in legno massello finitura Siberian Ash o Eucalipto, con inserti e supporti in cromo lucido o oro lucido. Ripiani in vetro extrachiaro o fumé. Piedi regolabili in altezza +2cm. Altezze di serie 260 e 300cm, disponibili anche su misura. Moduli da 60 e 100cm. Contenitori anta ribalta e battente con struttura in vetro fumé e ante in legno. Scrivania da 100cm in legno, attrezzabile con passacavo. Modulo TV con contenitore a giorno in legno da 160cm, per accogliere monitor fino a 65 pollici.

Vertical uprights and horizontal beams in solid wood finish Siberian Ash or Eucalipto, with inserts and supports in polished chrome or gold. Shelves in extra clear or smoked glass. Feet adjustable in height +2cm. Standard heights 260 and 300cm, also available in custom size. Modules of 60 or 100cm. Storage units with flap-down door or hinged door, with structure in smoked glass and doors in wood. Office desk in wood 100cm with optional cable entry. TV module with open storage unit in wood 160cm, can accommodate monitors up to 65 inches.

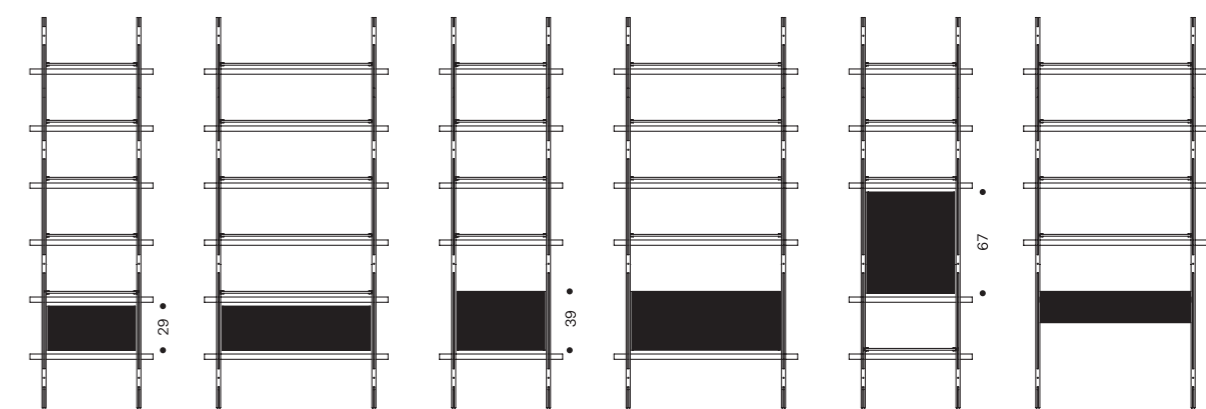
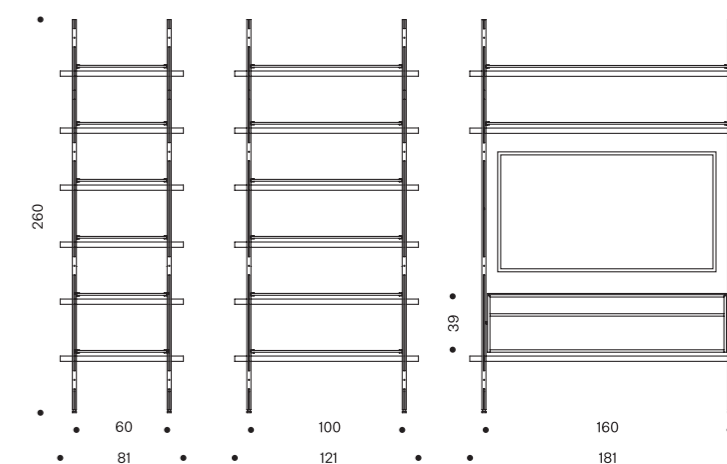

---

**Whirl**  
mirror

design  
**Francesco Forcellini**

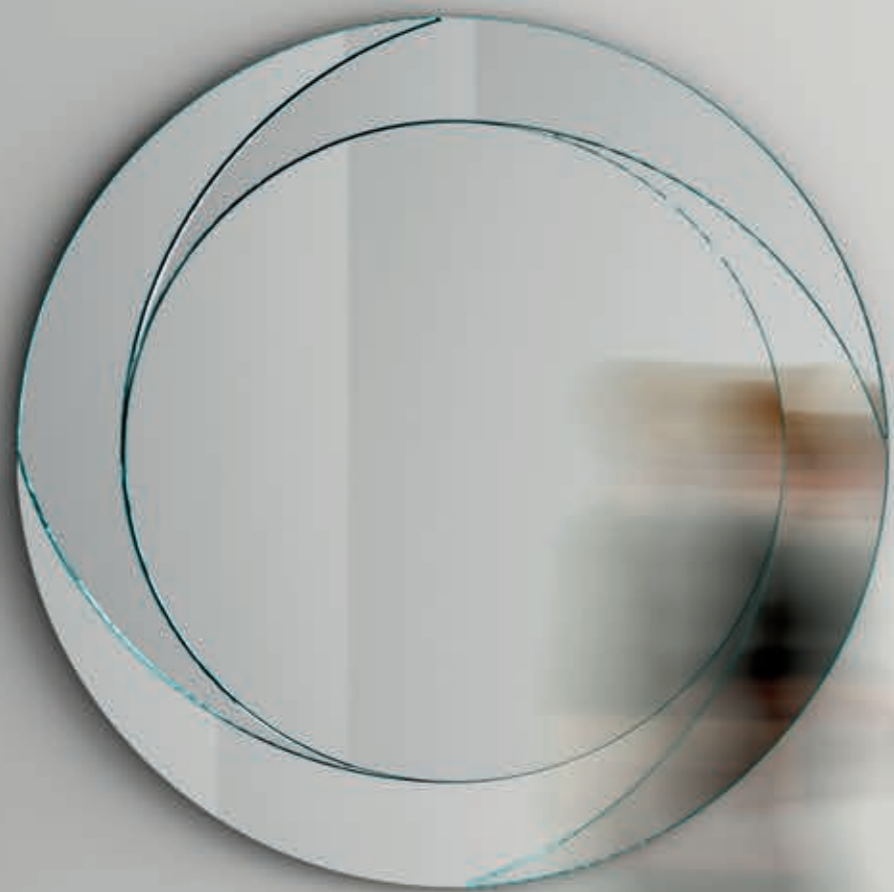

Whirl è la rappresentazione grafica minima del vortice. L'inclinazione dei quattro specchi esterni crea un gioco prospettico che rende dinamica ed energica l'immagine rispecchiata sullo specchio centrale.

Whirl is the minimum graphic representation of a vortex. The inclination of the 4 outer mirrors creates a prospective play that energizes and gives a dynamical view of the image reflected in the central mirror.





---

## Whirl mirror

design  
**Francesco Forcellini**

### INFO TECNICHE / TECHNICAL INFO

Specchio da parete con struttura in legno verniciata nero. E' disponibile in specchio, specchio fumè, bronzo e oro.

Wall mirror with black lacquered wooden structure. Available in mirror, smoked, bronze or gold mirror.

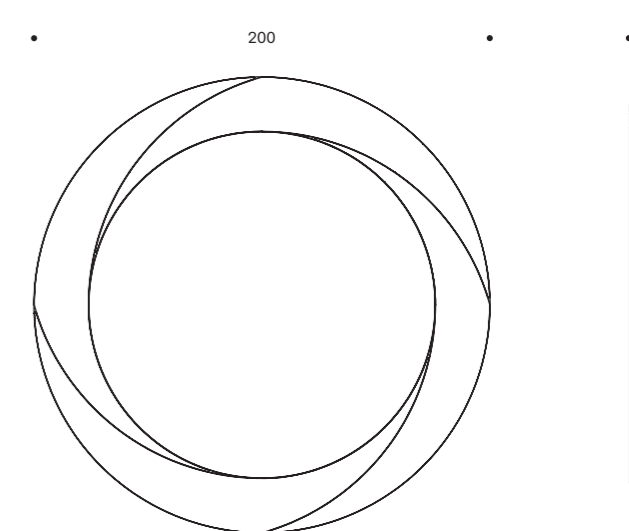

---

# Materials collection

## Collezione materiali

---

## Materiali / Materials

---

- 344 Vetro / Glass
- 344 Specchio / Mirror
- 344 Legno/ Wood
- 345 Marmo / Marble
- 346 Metallo / Metal
  
- 347 **She**  
Tessuto / Textile
  
- 348 **She**  
Pelle / Leather
  
- 349 **She**  
Ecopelle / Faux leather
  
- 350 **AW\_chair**  
**Soft Glass** sofa  
Tessuto / Textile

## Collezione materiali Materials collection

### Vetro / Glass

Extrachiaro  
Extra clear



Fumè  
Smoked



Bronzo  
Bronze



Fumè fuso  
Smoked fused



Bronzo fuso  
Bronze fused



### Specchio / Mirror

Specchio  
Mirror



Fumè  
Smoked



Bronzo  
Bronze



### Legno / Wood

Siberian Ash

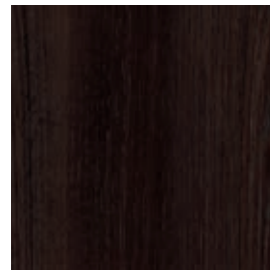

Eucalipto

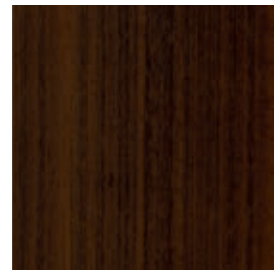

Rovere Naturale  
Natural Oak

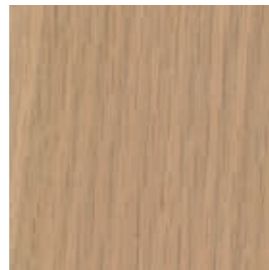

Noce canaletto  
Canaletto walnut

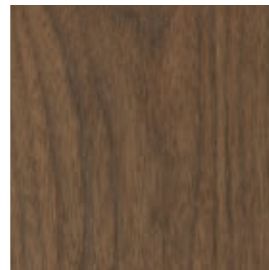

## Collezione materiali Materials collection

La riproduzione delle finiture su carta può riportare leggere differenze cromatiche rispetto agli originali.  
Finishes reproductions on paper can differ slightly from the original ones.

### Marmo / Marble

Tropikal storm

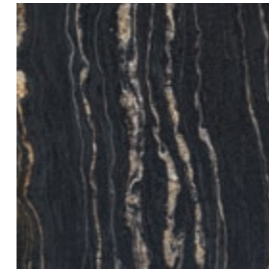

FINITURA SPAZZOLATA  
BRUSHED FINISHING

Arabescato Orobico  
Gold

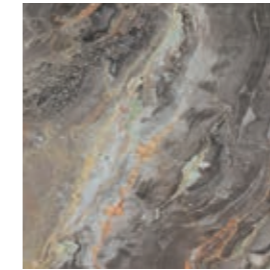

FINITURA SPAZZOLATA  
BRUSHED FINISHING

Domus White



FINITURA SPAZZOLATA  
BRUSHED FINISHING

Nero Marquinia

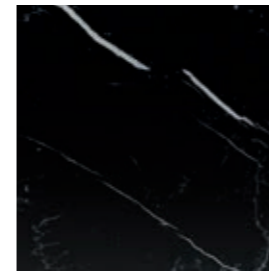

FINITURA SPAZZOLATA E LUCIDA  
BRUSHED AND POLISHED  
FINISHING

Bianco Carrara

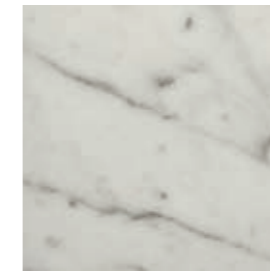

FINITURA SPAZZOLATA E LUCIDA  
BRUSHED AND POLISHED  
FINISHING

Sahara Noir

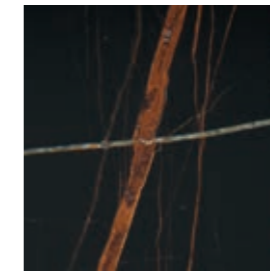

FINITURA SPAZZOLATA E LUCIDA  
BRUSHED AND POLISHED  
FINISHING

## Collezione materiali Materials collection

### Metallo / Metal

Cromo / Chrome



FINITURA LUCIDA  
POLISHED FINISHING

Cromo / Chrome



FINITURA SPAZZOLATA  
BRUSHED FINISHING

Oro / Gold



FINITURA LUCIDA  
POLISHED FINISHING

Oro / Gold



FINITURA SPAZZOLATA  
BRUSHED FINISHING

Rame / Copper



FINITURA LUCIDA  
POLISHED FINISHING

Rame / Copper



FINITURA SPAZZOLATA  
BRUSHED FINISHING

Canna di fucile / Gunmetal



FINITURA LUCIDA  
POLISHED FINISHING

Canna di fucile / Gunmetal



FINITURA SPAZZOLATA  
BRUSHED FINISHING

### Finiture su metallo / Metal finishing

Titanio



FINITURA SPAZZOLATA  
BRUSHED FINISHING

Champagne



FINITURA METALLIZZATA  
METALLIZED FINISHING

## She chair tessuto / textile

La riproduzione delle finiture su carta può riportare leggere differenze cromatiche rispetto agli originali. / Finishes reproductions on paper can differ slightly from the original ones.

### Tessuto / Textile F

F 413

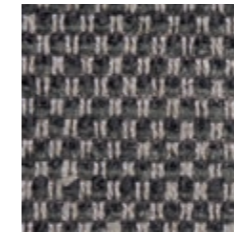

F 113

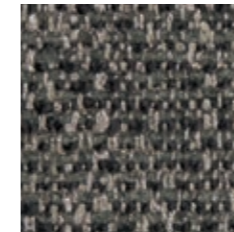

F 414

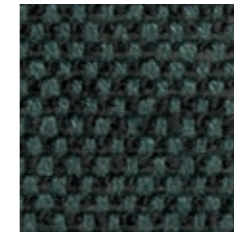

F 314



F 400



F 405



F 404



F 304

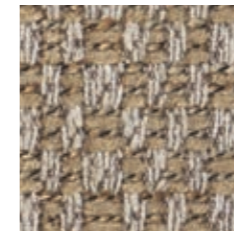

F 407

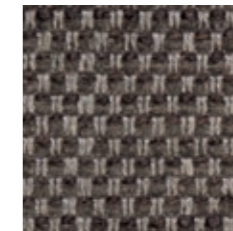

F 103

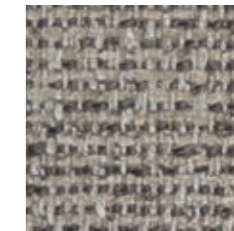

### Tessuto / Textile P

P 806



P 904



P 902



P 104

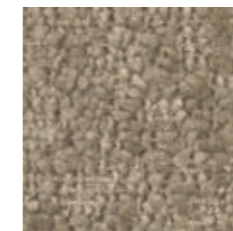

P 100



P 304



P 107

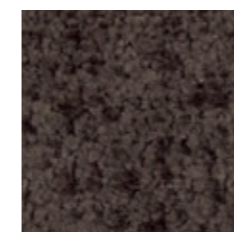

P 803



P 804

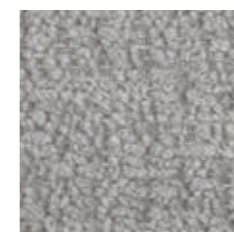

P 602

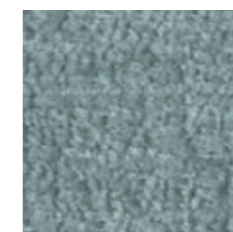

P 802



P 809



**She chair**  
pelle / leather

Bianco / White 5000	Panna / Cream 5506	Beige 5320	Verde Scuro / Dark Green - 5160	Bordeaux 5210
Marrone / Brown 5080	Cognac 5090	Marrone Chiaro / Light Brown - 5414	Marrone Scuro / Dark Brown - 5400	Testa di moro 5270
Grigio Chiaro / Light Grey - 5402	Grigio / Grey 5290	Grigio Scuro / Dark Grey - 5310	Nero / Black 5300	Blu 5260

**She chair**  
struttura metallo / metal structure

Cromo Lucido Polished Chrome	Canna Di Fucile Lucido Polished Gunmetal	Nero Opaco Matt Black	Grigio Antracite Opaco Matt Anthracite Grey	Bianco Opaco Matt White
---------------------------------	---	--------------------------	--	----------------------------

**She chair**  
ecopelle / faux leather

La riproduzione delle finiture su carta può ri-  
portare leggere differenze cromatiche rispet-  
to agli originali. / Finishes reproductions on  
paper can differ slightly from the original ones.

1001	1002	1003	1004	1005
1006	1007	1008	1009	1010
1011	1012	1013	1014	1015

**She chair**  
struttura metallo / metal structure

Cromo Lucido Polished Chrome	Canna Di Fucile Lucido Polished Gunmetal	Nero Opaco Matt Black	Grigio Antracite Opaco Matt Anthracite Grey	Bianco Opaco Matt White
---------------------------------	---	--------------------------	--	----------------------------



Tessuto / Textile B



Tessuto / Textile C

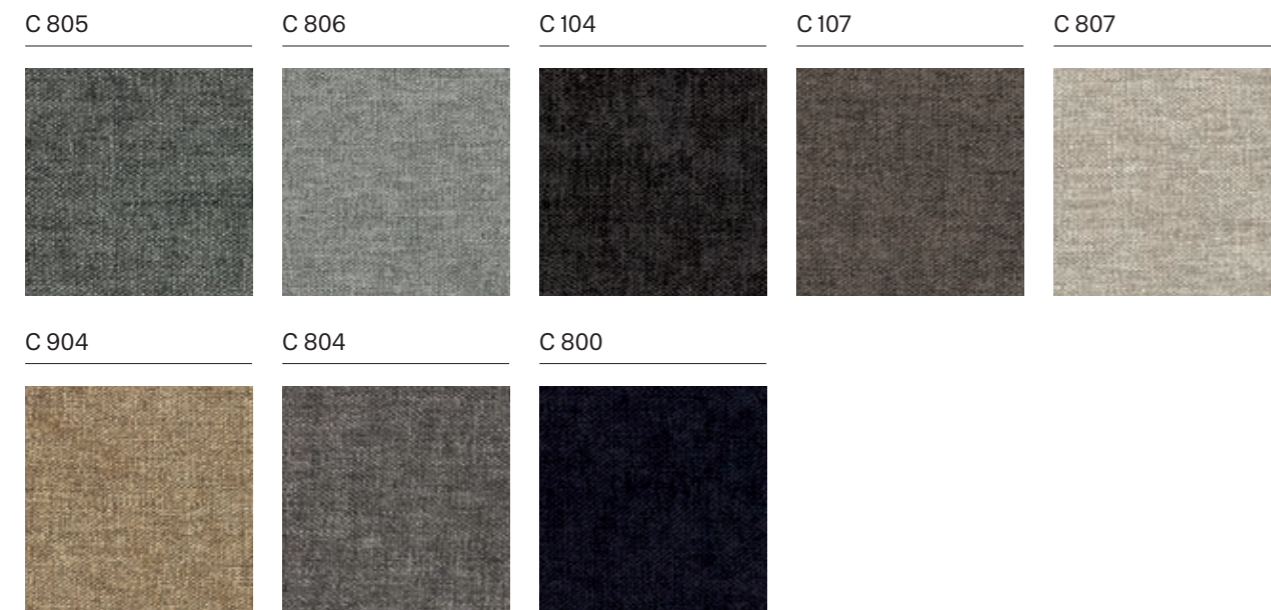

Tessuto / Textile F

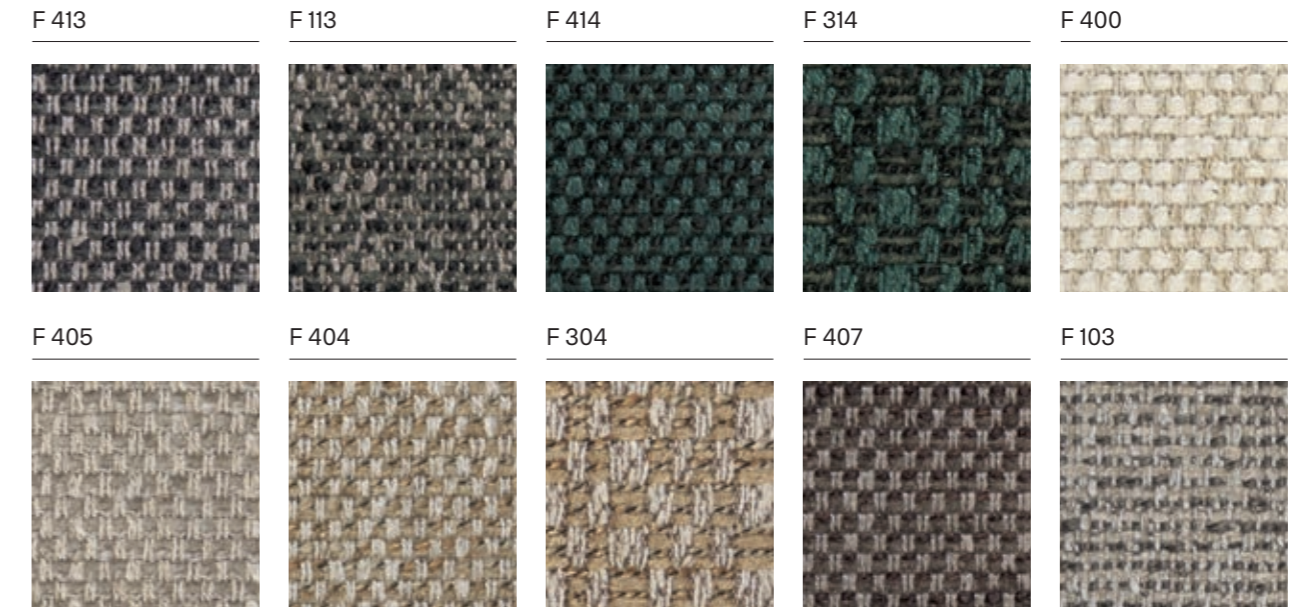

Tessuto / Textile P



# Tonellidesign

## **Tonelli Design**

T.D. Srl  
via Casali 40/42  
61122 - Pesaro (PU) Italy  
tel. +39 0721 481172  
[www.tonellidesign.it](http://www.tonellidesign.it)  
[info@tonellidesign.it](mailto:info@tonellidesign.it)  
[export@tonellidesign.it](mailto:export@tonellidesign.it)

-  Tonelli design
-  Tonelli\_Design
-  tonelli-design
-  Tonelli Design-Official

## **The New Modernism**

### **art direction**

Massimo Castagna / AD Architettura

### **digital images**

Garage121

### **graphic design**

Enrico Severi Design

### **post production**

MIC Studio

### **print**

Gruppo Leardini

Published April 2023

Tonelli Design / All rights reserved

**Tonelli**design