

**Tonelli**design

**The New Modernism**  
2021 Collection

**Tonelli**design

# The New Modernism

## Collection 2021

New Modernism nasce da una profonda, coraggiosa riflessione sull'abitare contemporaneo, dall'analisi del modo di abitare e da un pensiero che si lega al progetto di interior design nella sua accezione d'oggi.

La vocazione storica di Tonelli per la lavorazione del vetro, si apre a nuove interpretazioni, sorprendenti ed inaspettate, in affinità ad un modo di vivere la casa che riteniamo allineato ai tempi.

Un importante lavoro di ricerca verso nuove forme e funzioni, legate tra loro attraverso l'uso delle materie e delle relazioni che si creano, in un universo di nuovi significati.

La collezione 2021 si allarga alla casa nel suo insieme, un'interpretazione basata sul vetro, che risulta calda, accogliente, eclettica. Arredi diversi, in cui legni, metalli, pietre e pelli, abbinati al vetro suggeriscono un modello di casa originale e personale. Funzionalità e rigore, decorazione e presenze scultoree, sono la proposta di Tonelli ad un cliente alla ricerca di una casa unica e senza tempo, lontana da stili formali e stereotipati.

## Collection 2021

New Modernism was born of a deep, brave reflection on contemporary living, of an analysis of the way of living and of a thought linked to the project of interior design in its nowadays meaning.

Tonelli's historical vocation for glass manufacturing opens to new interpretations, surprising and unexpected, in kinship with a way of living the home we consider aligned with the present times.

An important research for new forms and functions, linked between them by using the materials and the relationships thus created, in a universe of new meanings.

Collection 2021 opens up to the home in its wholeness, an interpretation based on glass that results warm, welcoming, eclectic. Different furnishings where wood, metal, stones and leathers, combined with the glass, suggest an original and personal model of home. Functionality and rigor, decoration and sculptural presences, are Tonelli's proposals for a customer looking for a unique and timeless home, distant from formal and stereotypical styles.

# Index Collection

<b>Scenarios</b> furnishing proposals	6
<hr/>	
<b>Major</b> sideboard	19
<b>Marcell</b> console / desk / dressing table	33
<b>Whirl</b> mirror	45
<b>Crossover</b> dining table	53
<b>Perseo</b> dining table	67
<b>Hyperion</b> lamp	77
<b>Maybe</b> mirror	87
<b>She</b> chair	93
<hr/>	
Materials collection and data sheets	107



**Crossover** Tavolo / Table  
Vetro bronzo, Titanio spazzolato  
Bronze glass, brushed Titanio

**She** Sedia / Chair  
Canna di fucile lucido, pelle grigio scuro 5310  
Polished gunmetal, dark grey leather 5310

**Hemingway** Libreria / Bookcase  
Eucalipto, inserti cromo lucido, vetro extrachiario  
Eucalipto, polished chrome inserts, extra clear glass

**Whirl** Specchio / Mirror

**Crossover** Tavolo / Table  
Vetro fumè, canna di fucile  
Smoked glass, polished gunmetal

**She** Sedia / Chair  
Cromo lucido, pelle marrone scuro 5400  
Polished chrome, dark brown leather 5400

**Major** madia / sideboard  
Siberian Ash, vetro fumè  
Siberian Ash, smoked glass

**Hyperion** Lampada / Lamp  
Oro lucido, vetro pyrex soffiato trasparente  
Polished gold, transparent blown pyrex glass





**Marcell** Scrivitoio / Desk  
Vetro fumè, Siberian Ash  
Smoked glass, Siberian Ash

**She** Sedia / Chair  
Laccato nero opaco, ecopelle 1009  
Black matt lacquered, faux leather 1009

**Hemingway** Libreria / Bookcase  
Siberian Ash, inserti cromo lucido, vetro extrachiaro  
Siberian Ash, polished chrome inserts,  
extra clear glass

**Hyperion** Lampada / Lamp  
Canna di fucile lucido, vetro pyrex soffiato trasparente  
Polished gunmetal, transparent blown pyrex glass

**After9** Tavolini / Coffee Tables  
Marmo Arabescato Orobico Gold, vetro fumé,  
canna di fucile lucido, inox lucido.  
Arabescato Orobico Gold marble, smoked glass,  
polished gunmetal, polished stainless steel.

**Whirl** Specchio / Mirror







**Perseo** Tavolo / Table  
Vetro extra chiaro, Antracite spazzolato opaco  
Extra clear glass, matt brushed Antracite

**She** Sedia / Chair  
Canna di fucile lucido, pelle bianca 5000  
Polished gunmetal, white leather 5000

**Major** madia / sideboard  
Siberian Ash, vetro fumè  
Siberian Ash, smoked glass

**Hyperion** Lampada / Lamp  
Cromo lucido, vetro pyrex soffiato trasparente  
Polished chrome, transparent blown pyrex glass

**Livingstone Dark** Tavolo / Table  
Vetro bronzo, Eucalipto  
Bronze glass, Eucalipto

**She** Sedia / Chair  
Cromo lucido, ecopelle 1005  
Polished chrome, faux leather 1005

**Major** madia / sideboard  
Eucalipto, vetro bronzo  
Eucalipto, bronze glass

**Hyperion** Lampada / Lamp  
Cromo lucido, vetro pyrex soffiato trasparente  
Polished chrome, transparent blown pyrex glass



**Major**  
sideboard

design  
**Bellavista & Piccini**

Un mobile contenitore caratterizzato dalla struttura in vetro e dai frontali in essenza. Major offre composizioni pensate per i diversi usi e le diverse aree della casa, personalizzabili e variabili in base agli stili e ai gusti.

Sideboard featuring a glass structure and frontal parts in wood. Major offers compositions thought for different uses and different home areas, adaptable and changeable according to personal style and taste.

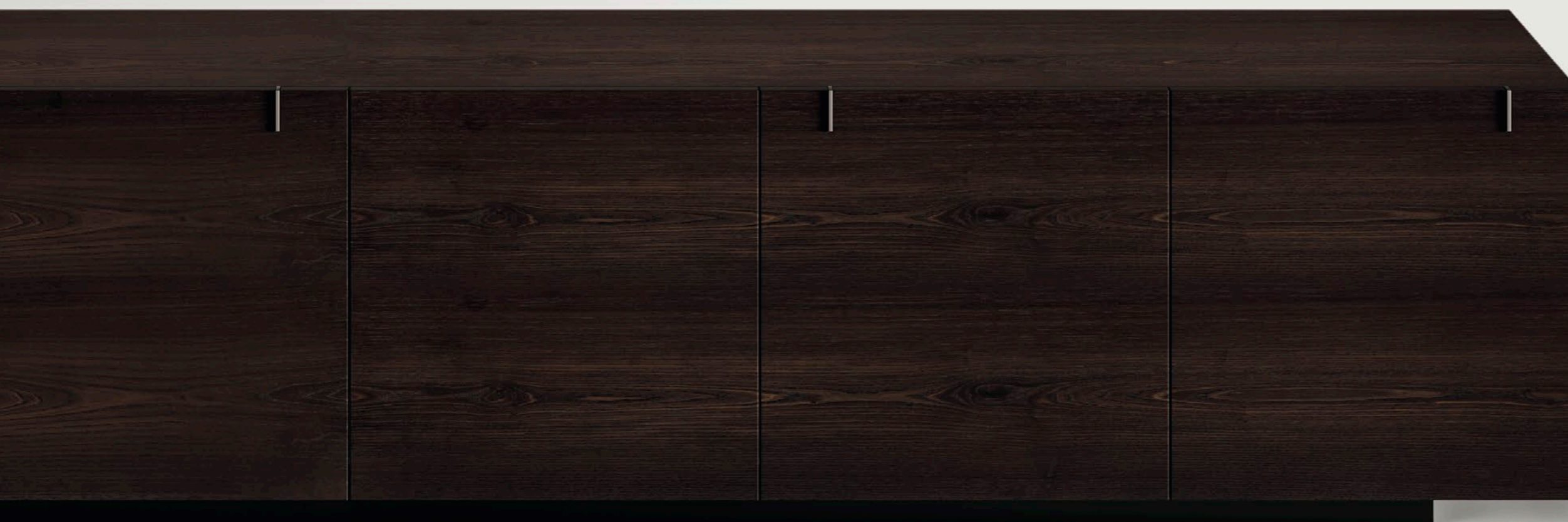



Le ante sono dotate di una sottile maniglia che, oltre a rappresentare un elegante dettaglio di design, integra il sistema magnetico di apertura e blocco.

The doors are equipped with a slim handle, an elegant design detail that completes the magnetic system of opening and halting.

La madia Major offre un sistema di apertura delle ante unico e innovativo. La combinazione di ante scorrevoli e battenti, permette alla madia di apparire sempre diversa e di essere utilizzata secondo le proprie esigenze.

Sideboard Major offers a unique and innovative door opening system. The combination of sliding and hinge doors allows the sideboard to always show different aspects and to be used according to one's necessities.









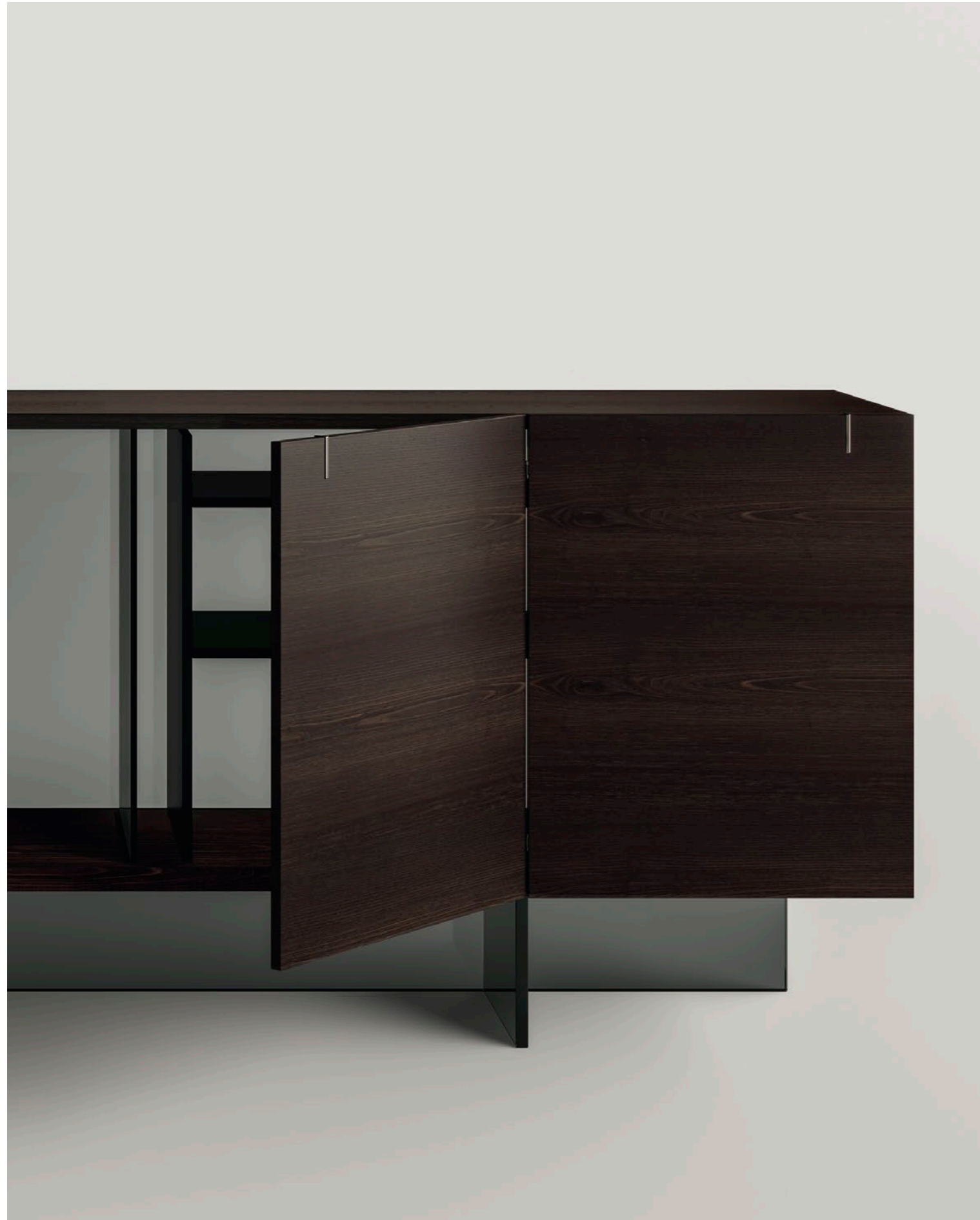

## Major sideboard

### INFO TECNICHE / TECHNICAL INFO

Madia composta da top, fondo e ante in legno a vena continua nelle finiture Eucalipto o Siberian Ash. Struttura verticale composta da fianchi, schiena e fianchi interni in vetro nelle versioni fumè o bronzo. Basamento in vetro extra chiaro spessore 19 mm oppure vetro fumè o bronzo stratificato spessore 10+10 mm. In alternativa, zoccolo in legno verniciato nero opaco con regolazione integrata. L'interno può essere personalizzato con comodi elementi divisori in legno laccato nero.

Sideboard made of top, bottom and doors in wood with continuous vein in Eucalipto and Siberian Ash finish. Vertical structure made of sides, back and internal partition in glass in smoked or bronze finish. Base in extra clear glass 19mm thick or stratified bronze or smoked glass 10+10mm. In alternative it can be with black lacquered wooden plinth with integrated regulation. The inside can be personalized with dividing elements in black lacquered wood.

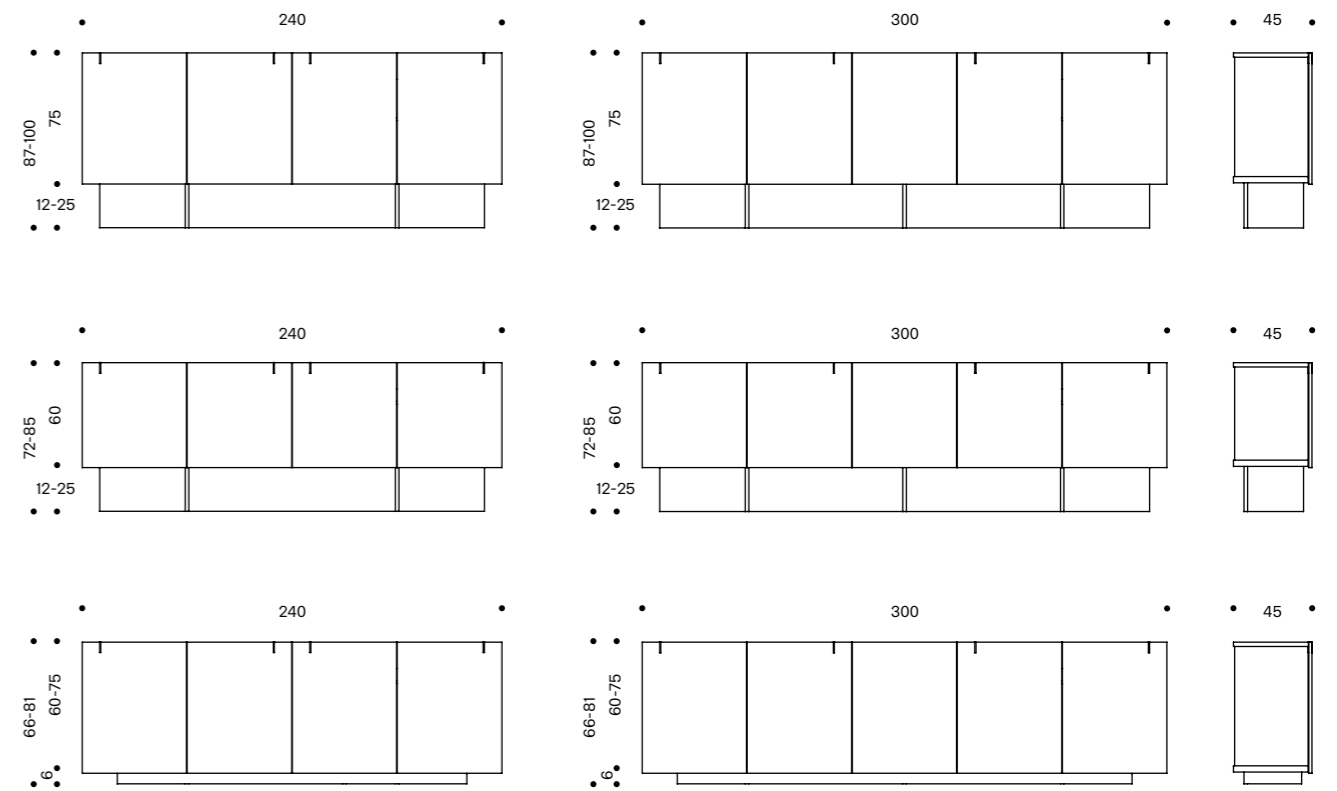

**Marcell**  
console / desk  
dressing table

design  
**Massimo Castagna**



Marcell rappresenta un classico senza tempo, definito dalle linee essenziali e rigorose del vetro e dal calore e matericità del legno.

Marcell represents a timeless classic, defined by the essential and rigorous lines of the glass and the warmth and texture of the wood.

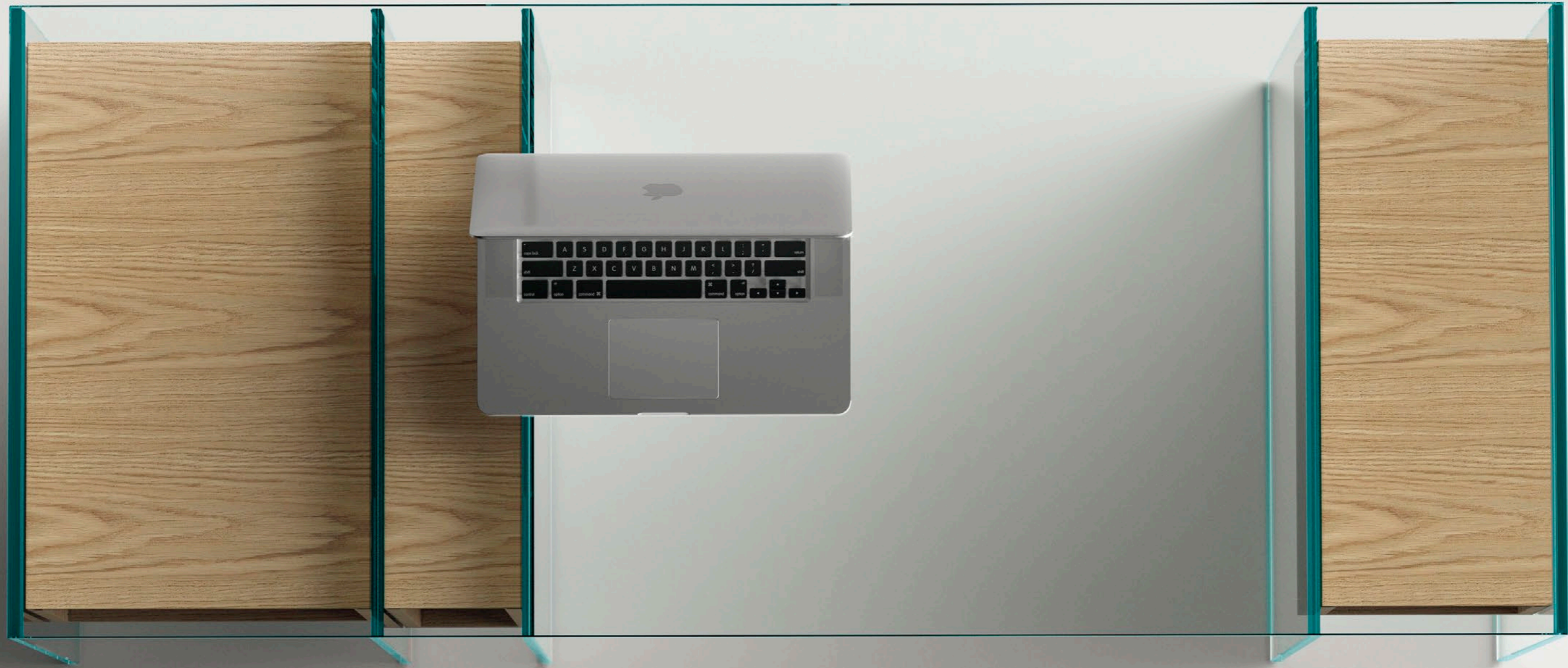

Grande versatilità d'uso nei diversi ambienti, Marcell nasce come scrittoio ma trova collocazione anche come consolle nell'ingresso e, se attrezzato con cassetti portaoggetti e specchio da appoggio, come dressing table diventando protagonista nella zona notte.

Great versatility for its use in different areas, Marcell is born as a desk but finds its place also as an entry console and, if equipped with glove box drawers and countertop mirror, as a dressing table, thus becoming the protagonist of the night area.

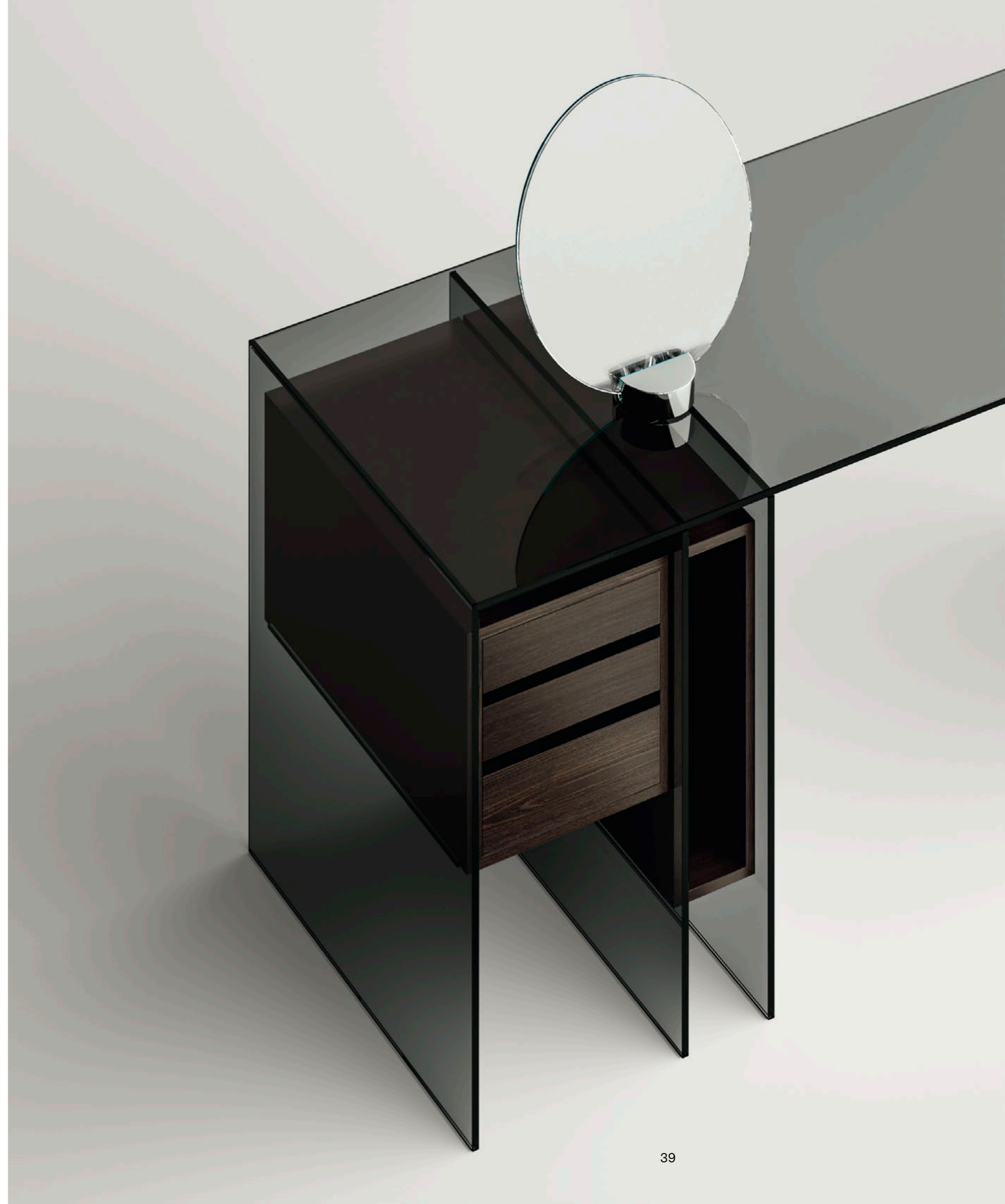

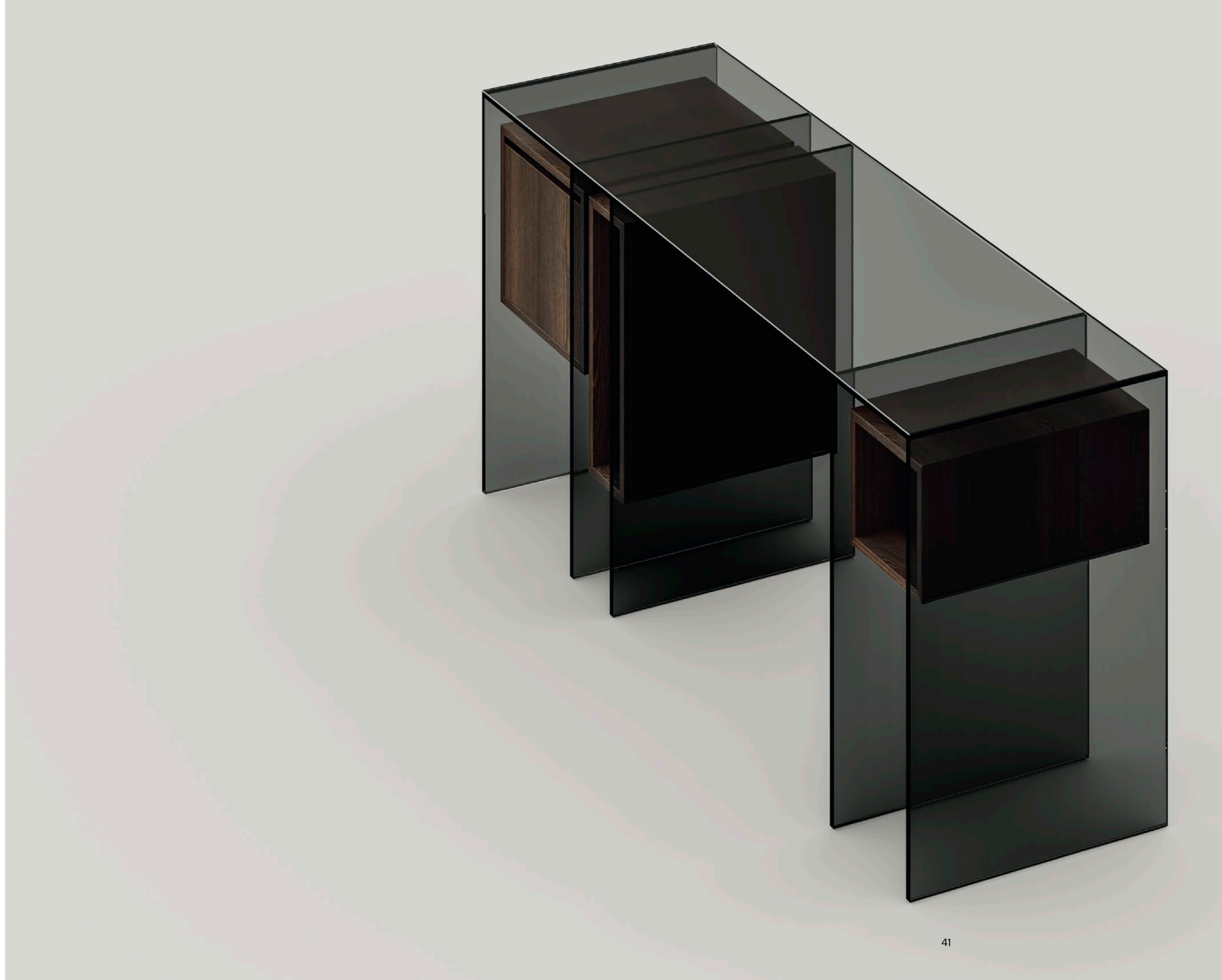



## Marcell console / desk dressing table

### INFO TECNICHE / TECHNICAL INFO

Consolle, scrittoio o dressing table con struttura incollata in vetro extra chiaro o fumè e contenitori in legno in finitura Eucalipto, Siberian Ash o Rovere Naturale. Sono optional l'anta battente SX o il set 3 cassetti in finitura abbinata. Lo scrittoio può essere completato con lo specchio in appoggio della stessa collezione con base in metallo cromato lucido.

Console, desk or dressing table with structure in glued glass extra clear or smoked and wooden storage units in Eucalipto, Siberian Ash or Natural Oak. Optional hinge door left or set of 3 drawers in matching finish. The desk can be completed with the countertop mirror of the same collection with polished chrome metal base.

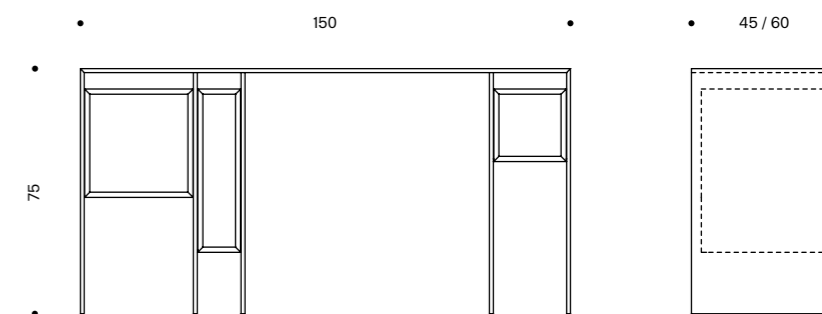

**Whirl**  
mirror

design  
**Francesco Forcellini**





Whirl è la rappresentazione grafica minima del vortice. L'inclinazione dei quattro specchi esterni crea un gioco prospettico che rende dinamica ed energica l'immagine rispecchiata sullo specchio centrale.

Whirl is the minimum graphic representation of a vortex. The inclination of the 4 outer mirrors creates a prospective play that energizes and gives a dynamical view of the image reflected in the central mirror.





## Whirl mirror

### INFO TECNICHE / TECHNICAL INFO

Specchio da parete con struttura in legno verniciata nero. E' disponibile in specchio, specchio fumè, bronzo e oro.

Wall mirror with black lacquered wooden structure. Available in mirror, smoked, bronze or gold mirror.

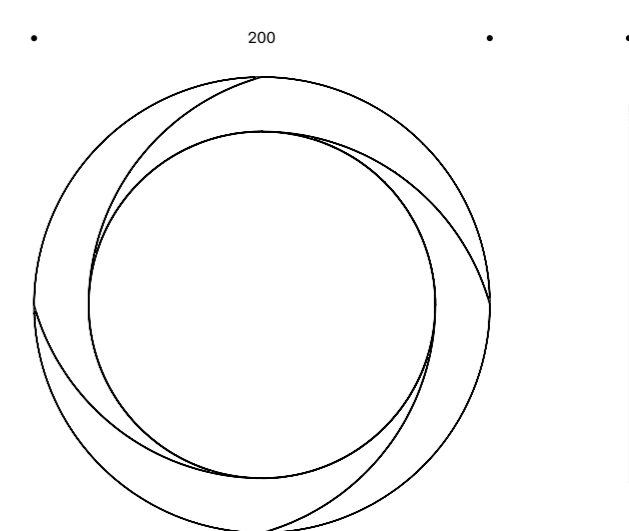

**Crossover**  
dining table

design  
**Massimo Castagna**

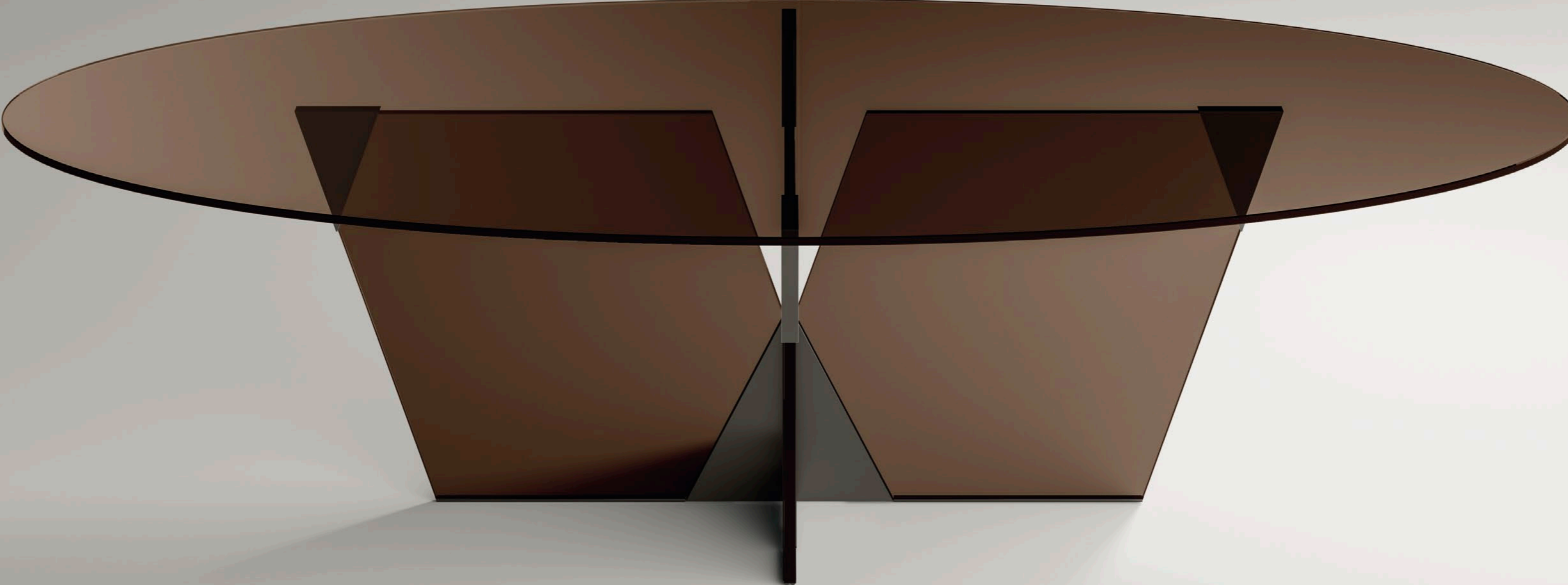

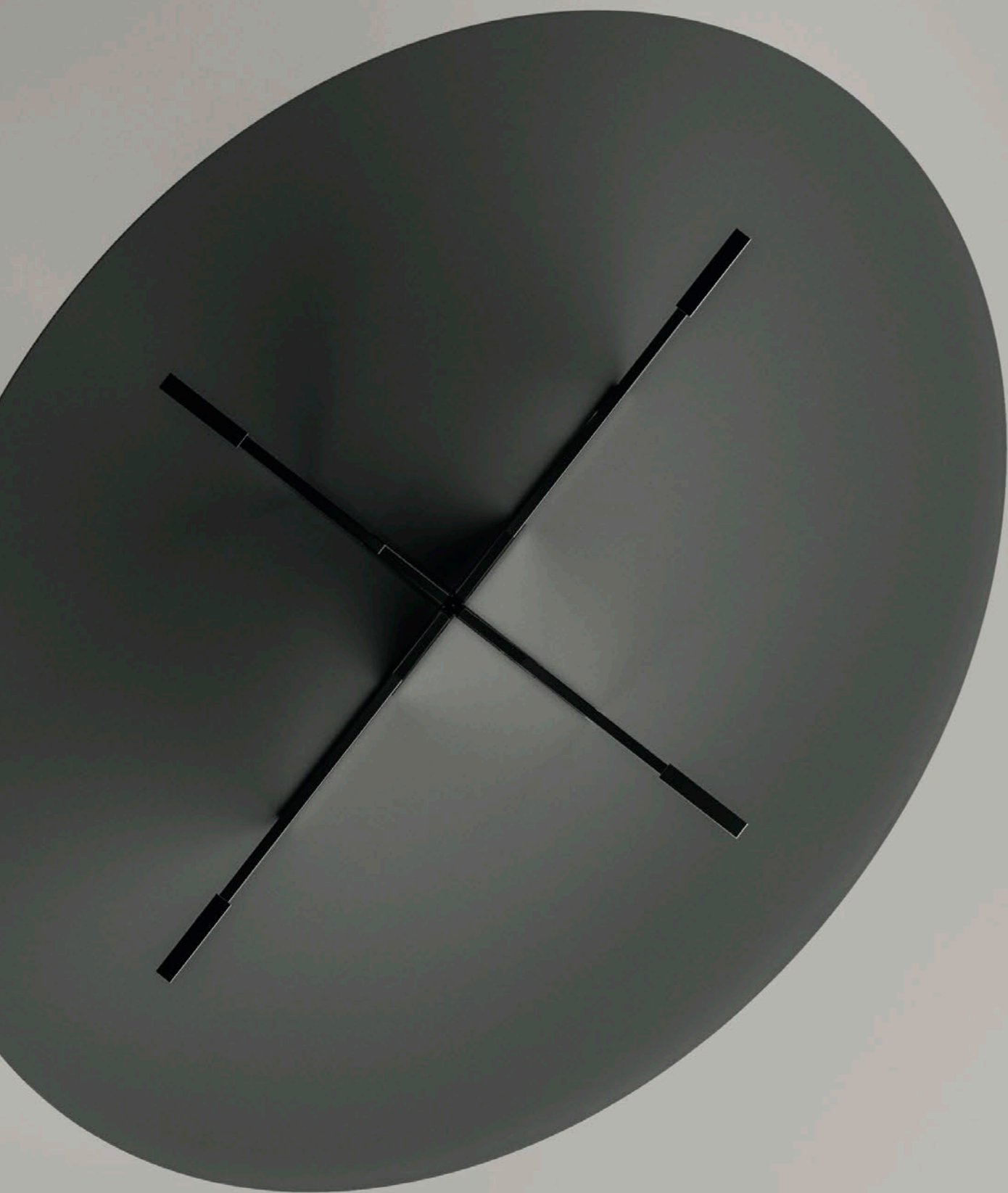

Una struttura scultorea ed elegante per il nuovo tavolo disegnato da Massimo Castagna. Capacità nel combinare materiali di diversa natura insieme alla straordinaria passione per la lavorazione del vetro permettono di modellare le forme e gli spessori fino a definire un'immagine di forza e di carattere.

A sculptural and elegant structure for the new table designed by Massimo Castagna. The ability to combine materials of different nature together with the extraordinary passion for glass processing allow to shape forms and thicknesses up until an image of great force and character is defined.

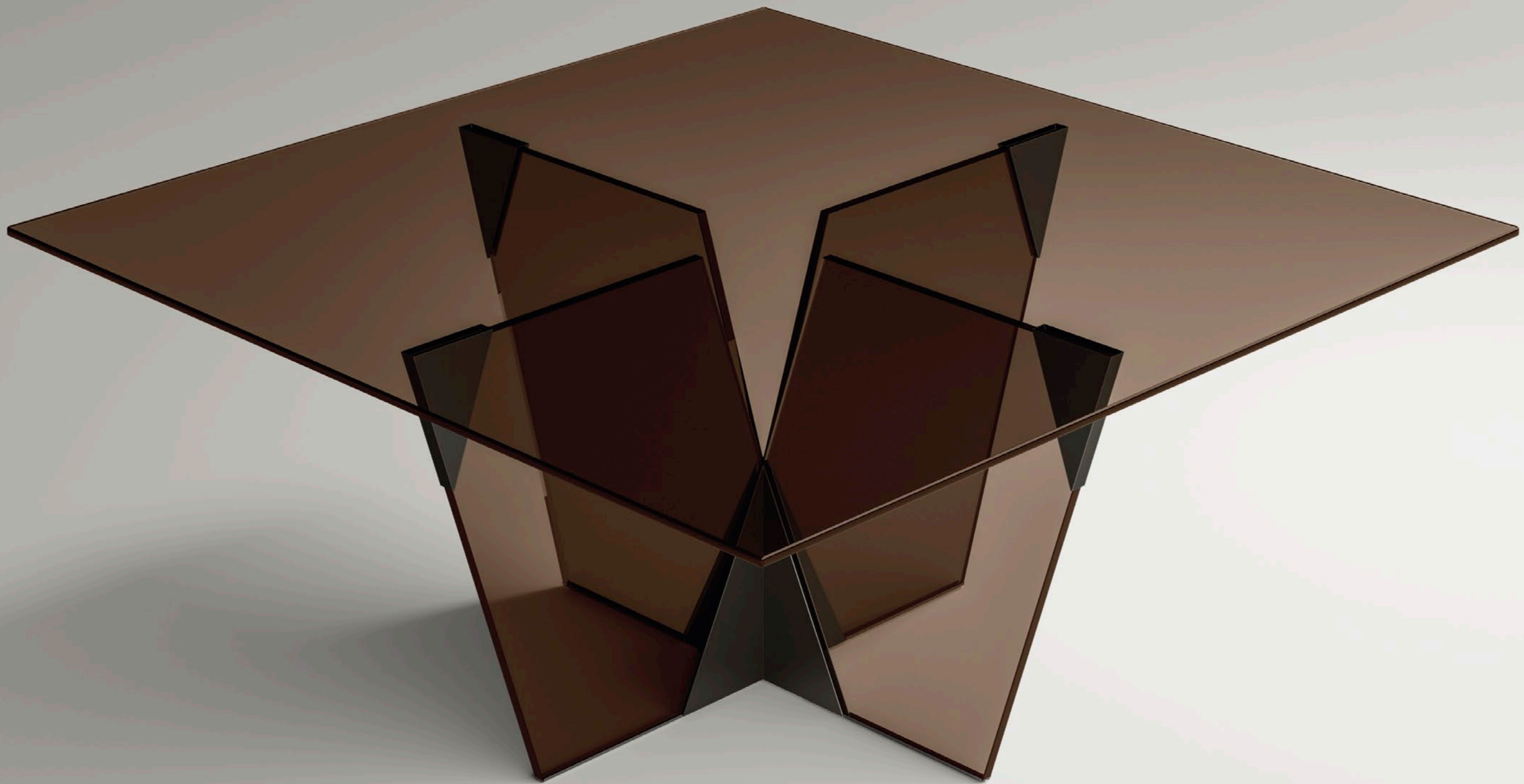

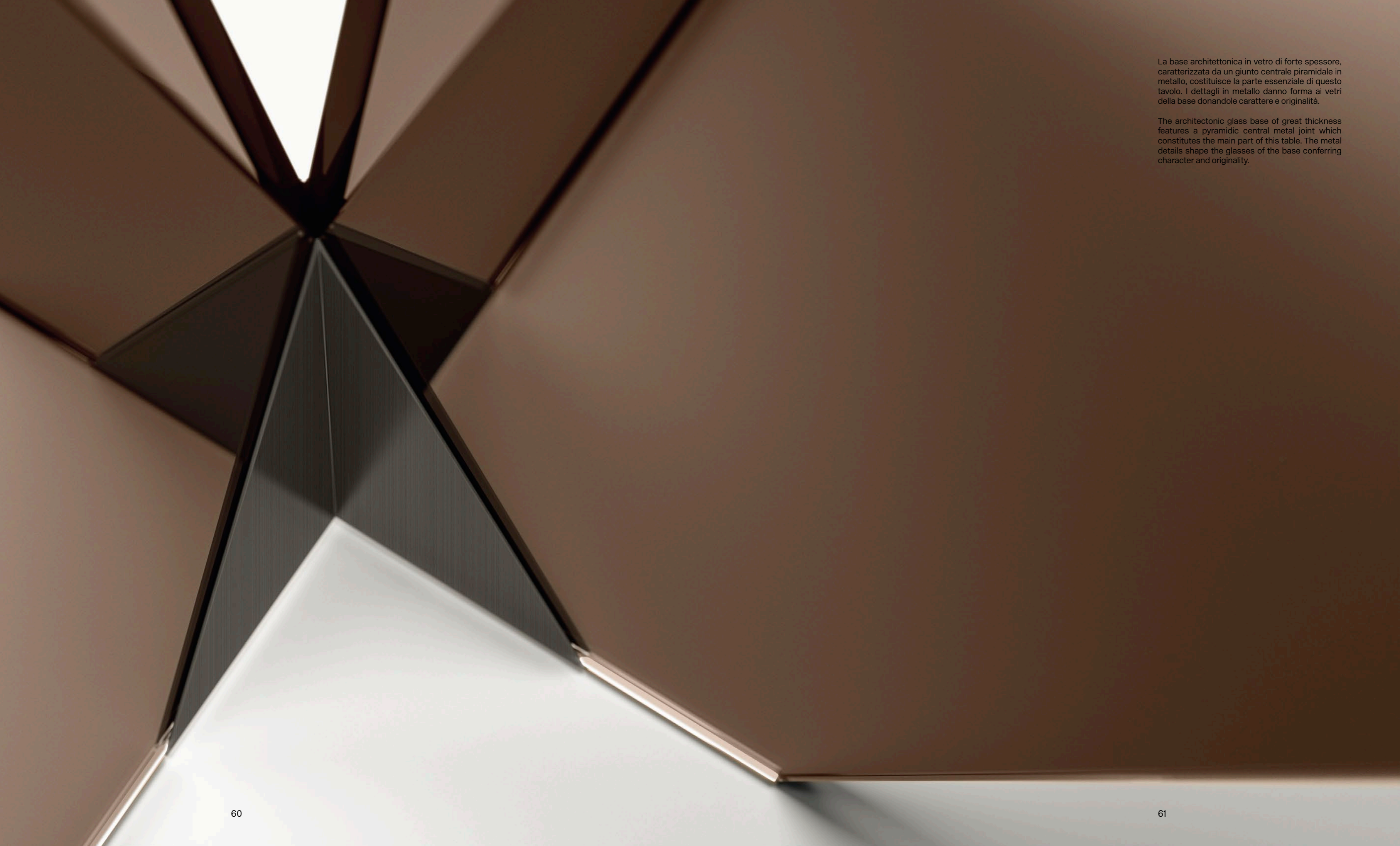

La base architettonica in vetro di forte spessore, caratterizzata da un giunto centrale piramidale in metallo, costituisce la parte essenziale di questo tavolo. I dettagli in metallo danno forma ai vetri della base donandole carattere e originalità.

The architectonic glass base of great thickness features a pyramidal central metal joint which constitutes the main part of this table. The metal details shape the glasses of the base conferring character and originality.



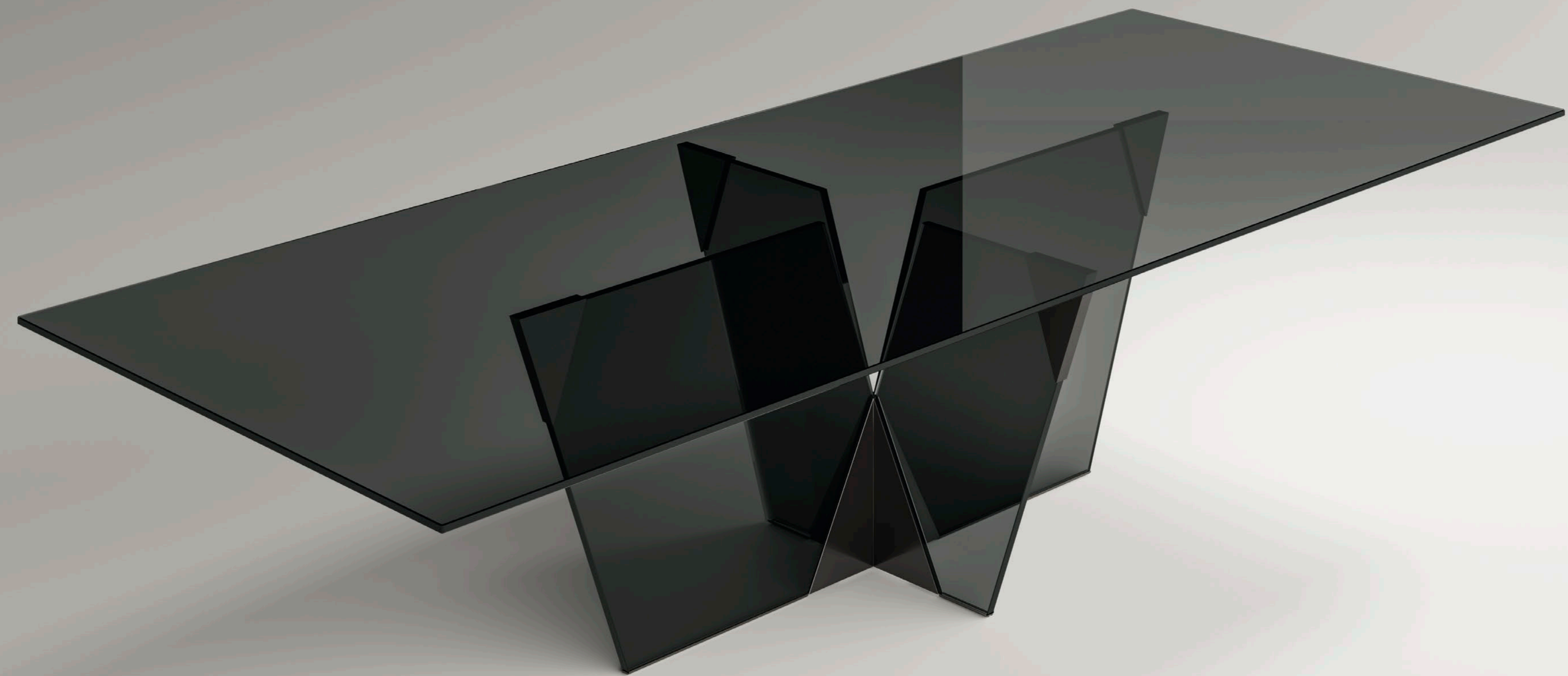



## Crossover dining table

### INFO TECNICHE / TECHNICAL INFO

Tavolo con basamento centrale in vetro extra chiaro, fumè o bronzo stratificato in spessore 10+10mm. Giunto centrale e supporti del piano in metallo finitura canna di fucile lucido o Titanio spazzolato opaco. La base è completamente smontabile e il piano è in appoggio con piastre metalliche per il centraggio. Piano in vetro extra chiaro temperato spessore 15mm oppure in vetro fumè o bronzo stratificato in spessore 10+6mm.

Table with base in extra clear, smoked or bronze stratified glass 10+10mm. Central joint and top supports in metal in polished gunmetal or matt brushed Titanium finish. The base is completely demountable and the table top rests on the base with metal plates for the centring. Table top in extra clear tempered glass of 15mm or in stratified smoked or bronze glass in 10+6mm.

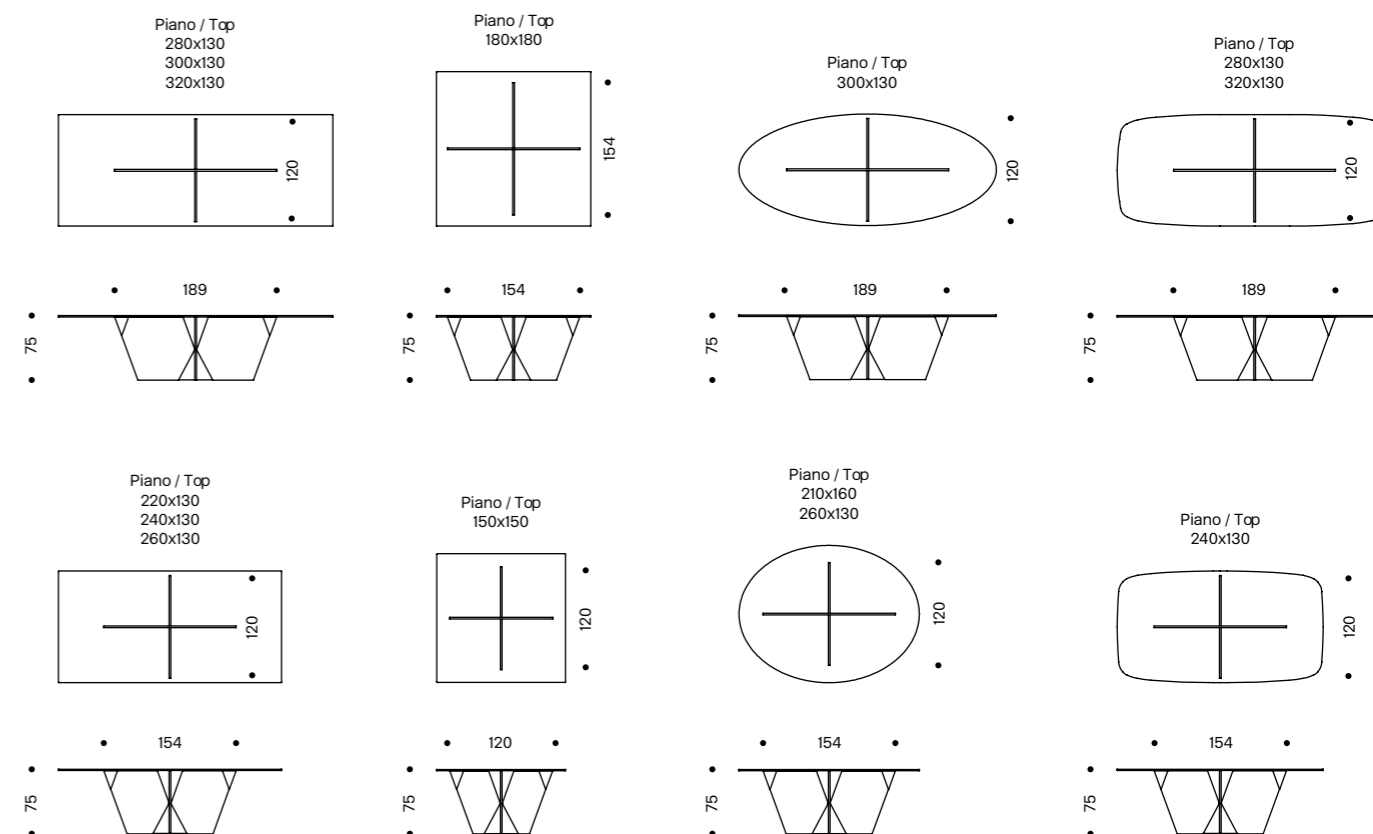

**Perseo**  
dining table

design  
**Paolo Grasselli**

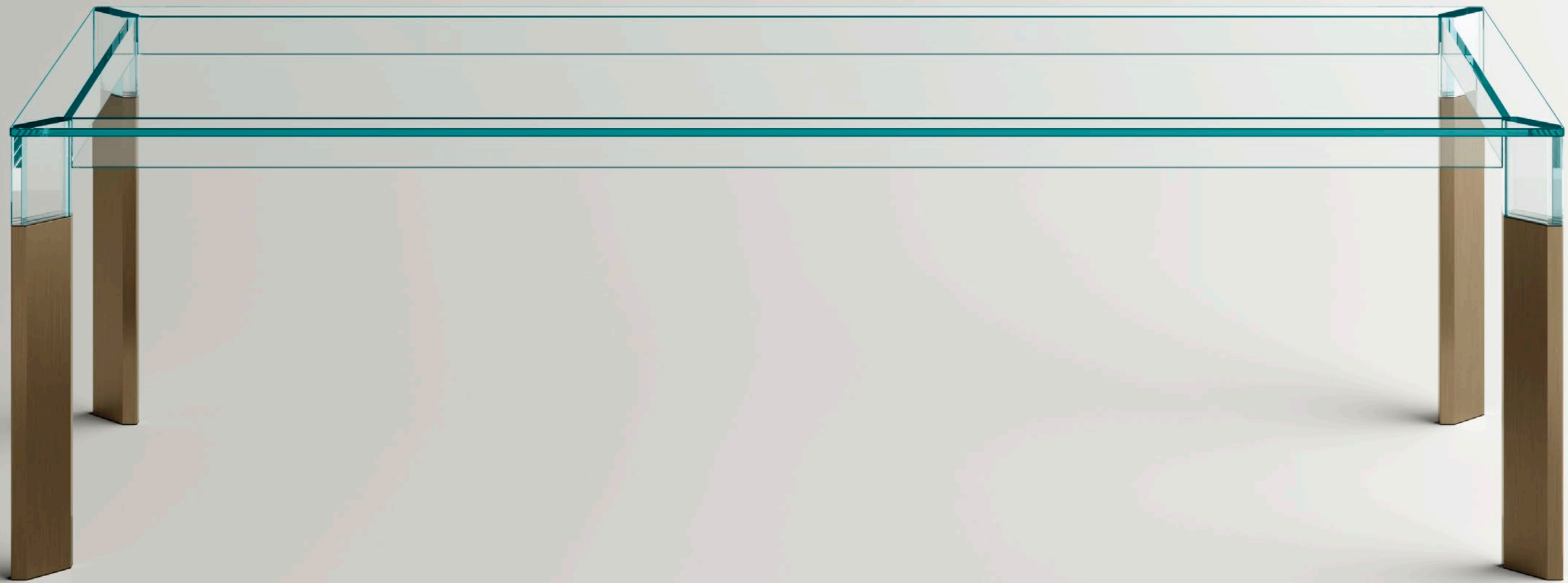



Grande protagonista tra i nostri tavoli, Perseo ha sempre saputo valorizzare l'unione del vetro ad altri materiali favorendone la versatilità abitativa all'interno degli spazi. Nella sua eleganza si legono tecniche costruttive complesse realizzate grazie alle abilità dei nostri artigiani.

Great protagonist among our tables, Perseo always knew how to enhance the combination of glass and other materials, thus gaining in versatility in its use. Complex construction techniques, obtained by the ability of our artisans, are to be seen in its elegance.

Oltre alle finiture già disponibili si aggiungono quelle nuove spazzolate opache per le gambe che rendono Perseo un tavolo senza tempo e adatto a stili diversi.

Beyond the already available finishes, two new brushed finishes for the legs are added that make Perseo a timeless table, adaptable to different styles.

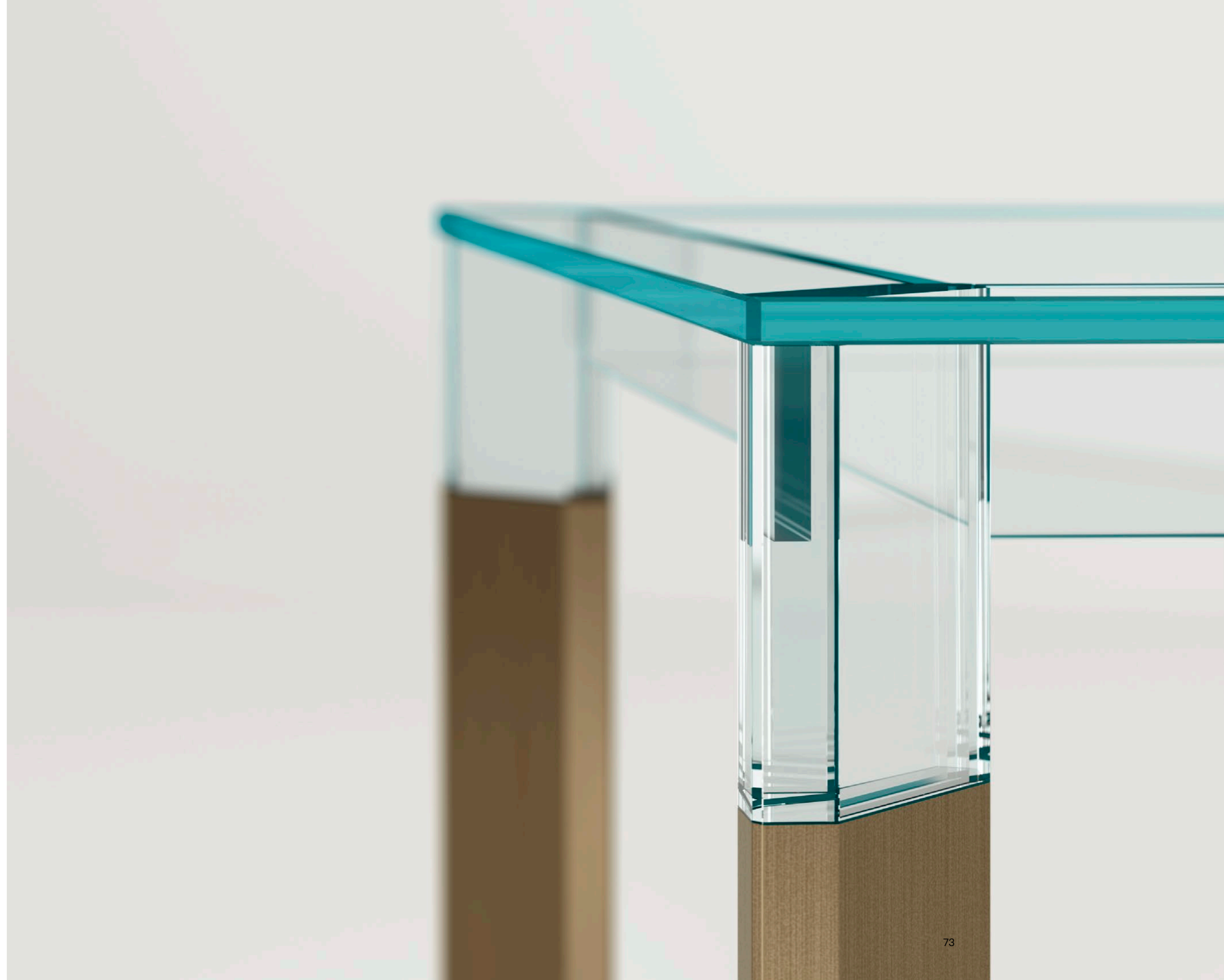



## Perseo dining table

### INFO TECNICHE / TECHNICAL INFO

Tavolo rettangolare o quadrato in vetro extra chiaro. Gambe smontabili nelle nuove finiture Antracite e Ottone spazzolato opaco.

Rectangular or square table in extra clear glass. Removable legs in the new finishes matt brushed Antracite or Ottone.

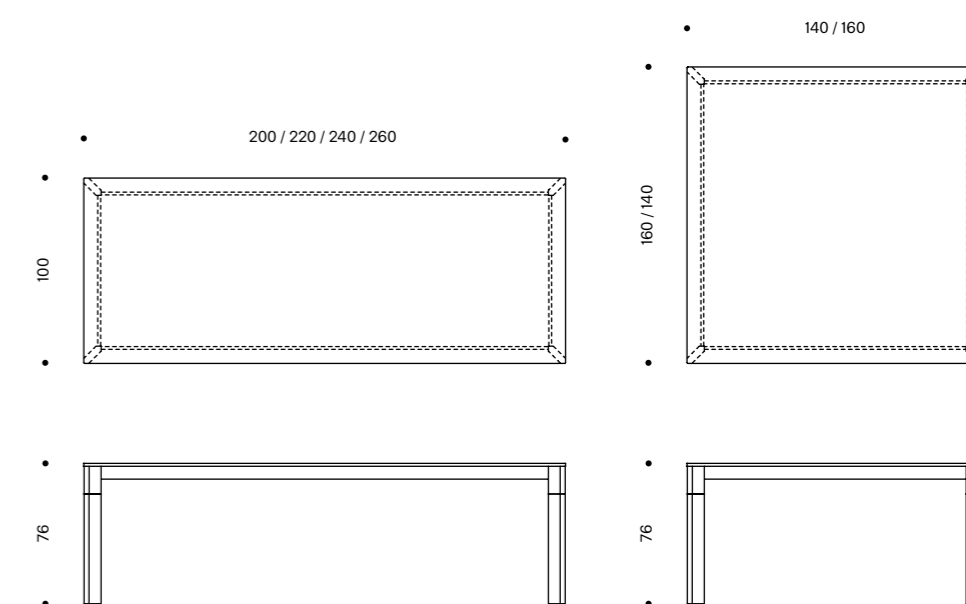

**Hyperion**  
lamp

design  
**Massimo Castagna**





Ad arricchire la collezione di lampade, nuove versioni da tavolo di Hyperion realizzate con le due dimensioni dei vetri di forma cubica arrotondata. Utilizzabili sia per uso singolo che insieme abbinando le diverse altezze e larghezze.

The lamp collection Hyperion is enriched by the new table lamp versions with two dimensions of the rounded cube shaped glass. It can be used individually or combining the different heights and widths.



Elementi di grande pulizia formale che trovano collocazione all'interno dei vari ambienti della casa, dalla zona living alla zona notte fino allo studio.

Elements of very clean shapes that can be placed in several areas of a home, from the living area to the sleeping area or the office.





## Hyperion lamp

### INFO TECNICHE / TECHNICAL INFO

Collezione di lampade da tavolo. Luce LED G9 3000K. Lampadina dimmerabile. Cubi in vetro pyrex soffiato trasparente. Parti metalliche disponibili nelle finiture cromo lucido, oro lucido e canna di fucile lucido.

Collection of table lamps. LED light G9 3000K. Dimmable bulb. Cubes in transparent blown Pyrex glass. Metal parts available in polished chrome, polished gold and polished gunmetal.

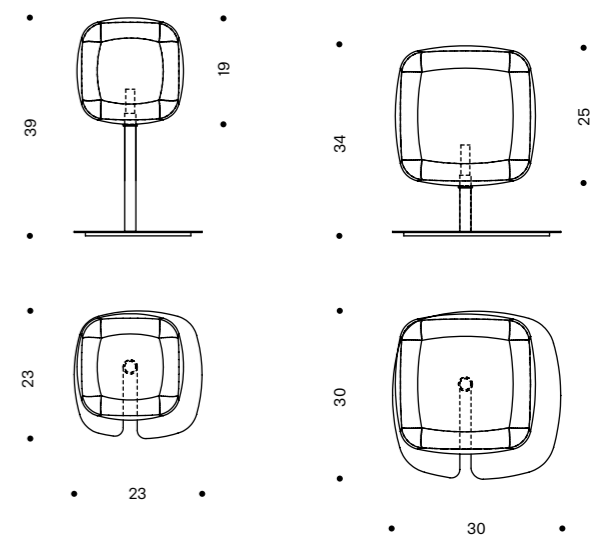

**Maybe**  
mirror

design  
**Massimo Castagna**

Specchio da parete pensato per creare diverse composizioni grazie al suo segno grafico. Una texture molto elegante e raffinata ottenuta dalla sovrapposizione di specchi diversi per forma e dimensione.

Wall mirror intended for the creation of different compositions thanks to its graphic design. A very elegant and refined texture obtained by the juxtaposition of mirrors of different shapes and dimensions.





## Maybe mirror

### INFO TECNICHE / TECHNICAL INFO

Specchio modulare a parete realizzato con struttura in legno. E' disponibile in specchio, specchio oro, bronzo o fumé.

Modular wall mirror made with wooden structure. Available in mirror, gold, bronze or smoked mirror.

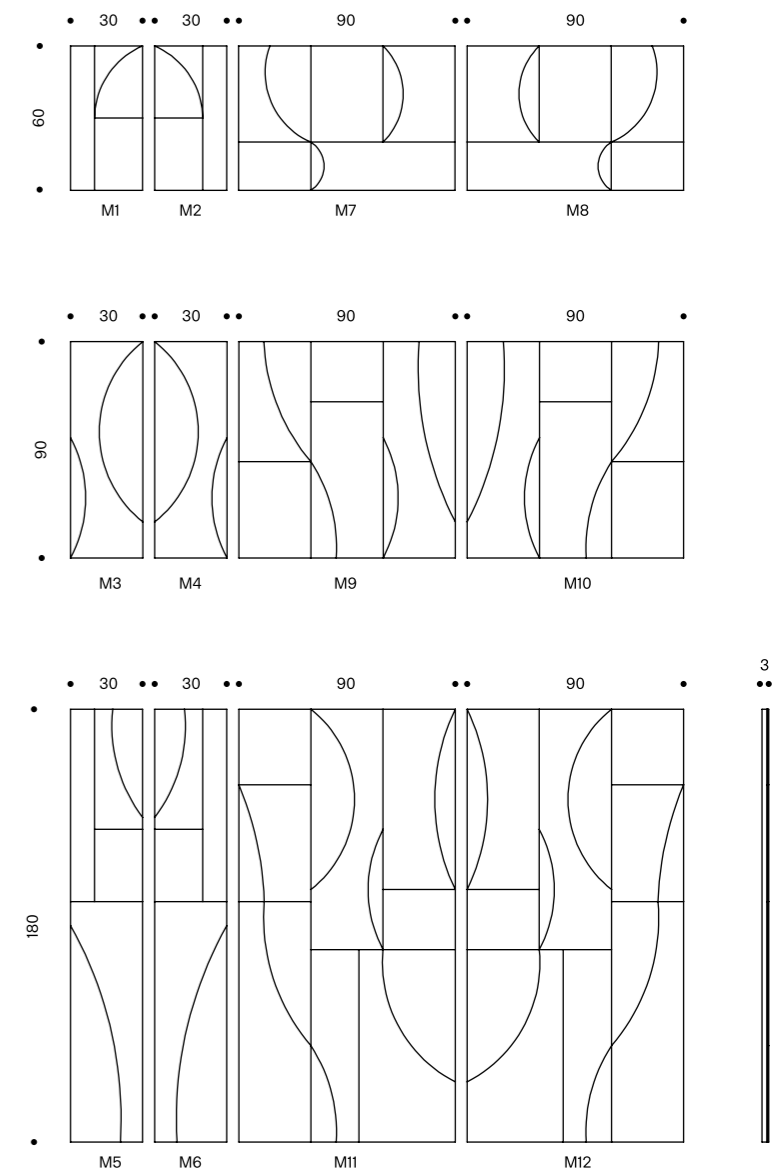

**She**  
chair

design  
**Massimo Castagna**



Dal design contemporaneo, la sedia She è frutto dell'incontro tra innovazione tecnologica e lavorazione artigianale.

A contemporary design, the She chair is the result of the encounter between technological innovation and artisan processing.



She è caratterizzata da una struttura in tondino metallico piegato e da una imbottitura finemente lavorata con cuciture esterne per una funzione sia tecnica che estetica. Ideale sia nel contesto domestico che in ambito contract grazie al suo design senza tempo e alla sua grande comodità.

She is characterized by a structure made of bent metal rod and upholstery finely processed with external stitching granting both technical and aesthetic functionality. Ideal for either domestic use or for contract thanks to its timeless design and great comfort.











## She chair

### INFO TECNICHE / TECHNICAL INFO

Sedia con struttura in tubolare di metallo da 20mm, disponibile nelle finiture cromo lucido e canna di fucile lucido o verniciata gofrata nero, grigio antracite e bianco. Seduta e schienale imbottiti in pelle o ecopelle.

Chair with rod shaped metal structure of 20mm, available in following finishes: polished chrome and polished gunmetal or embossed matt black, white or anthracite grey lacquered. Upholstered seat and backrest in leather or faux leather.

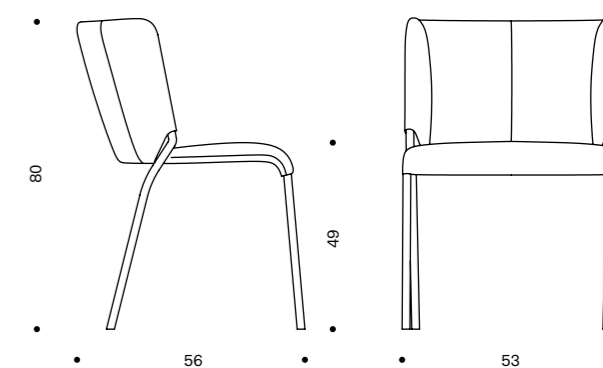

Materials  
collection and  
data sheets

Collezione materiali  
Materials collection

**Vetro / Glass**  
Extrachiaro / Extra clear



**Vetro / Glass**  
Fumè / Smoked

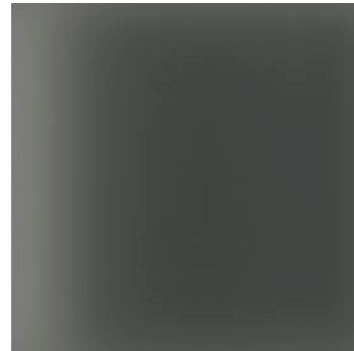

**Vetro / Glass**  
Bronzo / Bronze



**Marmo / Marble**  
Tropikal storm



**Marmo / Marble**  
Arabescato Orobico Gold



**Marmo / Marble**  
Domus White

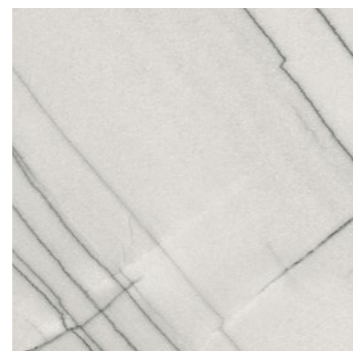

**Granito / Granite**  
Ceppo di Grè



**Legno / Wood**  
Siberian Ash



**Legno / Wood**  
Eucalipto

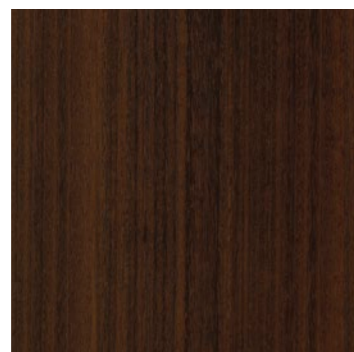

**Legno / Wood**  
Rovere Naturale / Natural Oak



Collezione materiali  
Materials collection

La riproduzione delle finiture su carta può riportare leggere differenze cromatiche rispetto agli originali. Finishes reproductions on paper can differ slightly from the original ones.

**Metallo / Metal**  
Cromo / Chrome



FINITURA LUCIDA  
POLISHED FINISHING

**Metallo / Metal**  
Cromo / Chrome



FINITURA SPAZZOLATA  
BRUSHED FINISHING

**Metallo / Metal**  
Oro / Gold



FINITURA LUCIDA  
POLISHED FINISHING

**Metallo / Metal**  
Oro / Gold

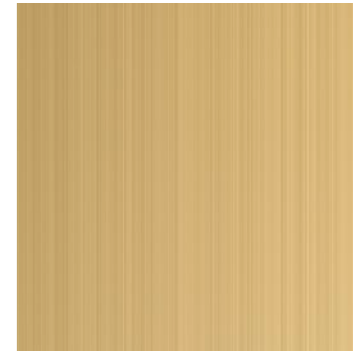

FINITURA SPAZZOLATA  
BRUSHED FINISHING

**Metallo / Metal**  
Rame / Copper



FINITURA LUCIDA  
POLISHED FINISHING

**Metallo / Metal**  
Rame / Copper

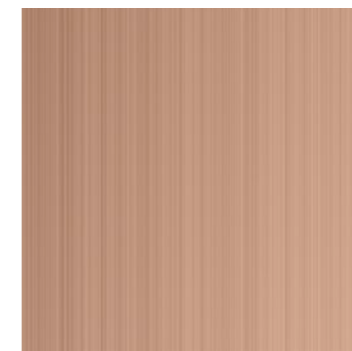

FINITURA SPAZZOLATA  
BRUSHED FINISHING

**Metallo / Metal**  
Canna di fucile / Gunmetal



FINITURA LUCIDA  
POLISHED FINISHING

**Metallo / Metal**  
Canna di fucile / Gunmetal



FINITURA SPAZZOLATA  
BRUSHED FINISHING

**Finiture su metallo / Metal finishing**  
Titanio



FINITURA SPAZZOLATA OPACO  
MATT BRUSHED FINISHING

**Finiture su metallo / Metal finishing**  
Terracotta

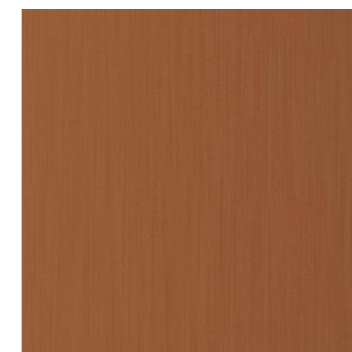

FINITURA SPAZZOLATA OPACO  
MATT BRUSHED FINISHING

**Finiture su metallo / Metal finishing**  
Antracite



FINITURA SPAZZOLATA OPACO  
MATT BRUSHED FINISHING

**Finiture su metallo / Metal finishing**  
Ottone



FINITURA SPAZZOLATA OPACO  
MATT BRUSHED FINISHING



**She chair**  
pelle / leather



**She chair**  
struttura metallo / metal structure

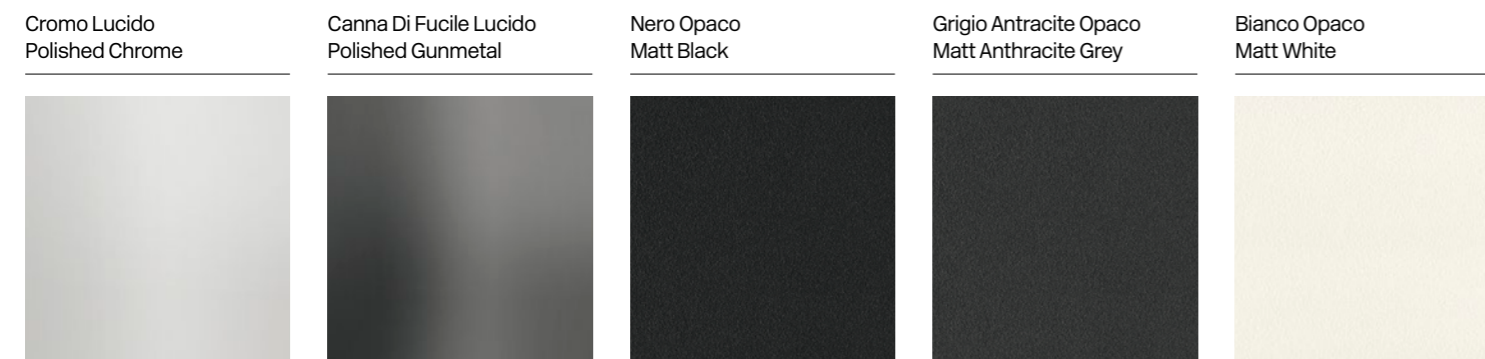

**She chair**  
ecopelle / faux leather

La riproduzione delle finiture su carta può riportare leggere differenze cromatiche rispetto agli originali. / Finishes reproductions on paper can differ slightly from the original ones.



**She chair**  
struttura metallo / metal structure

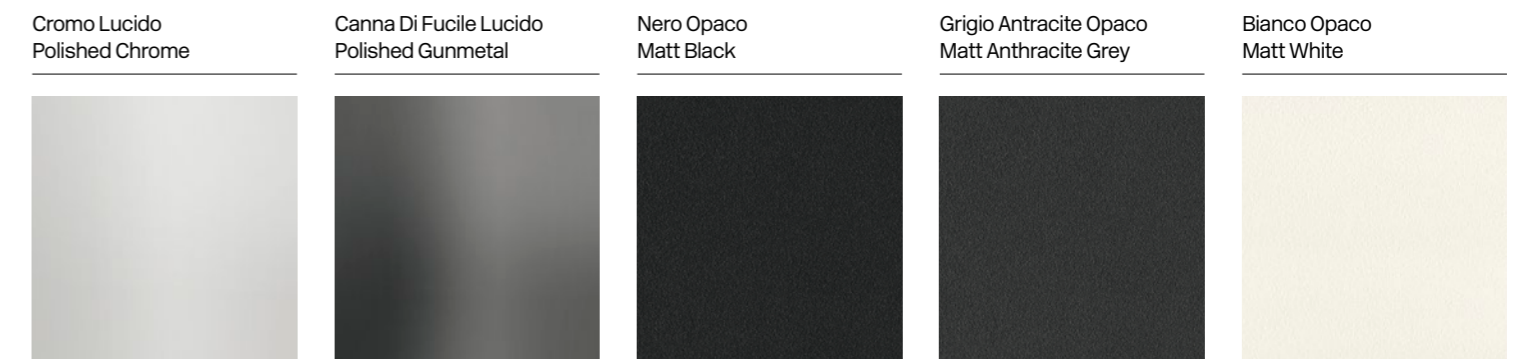

# Major sideboard

Modularità  
Modularity

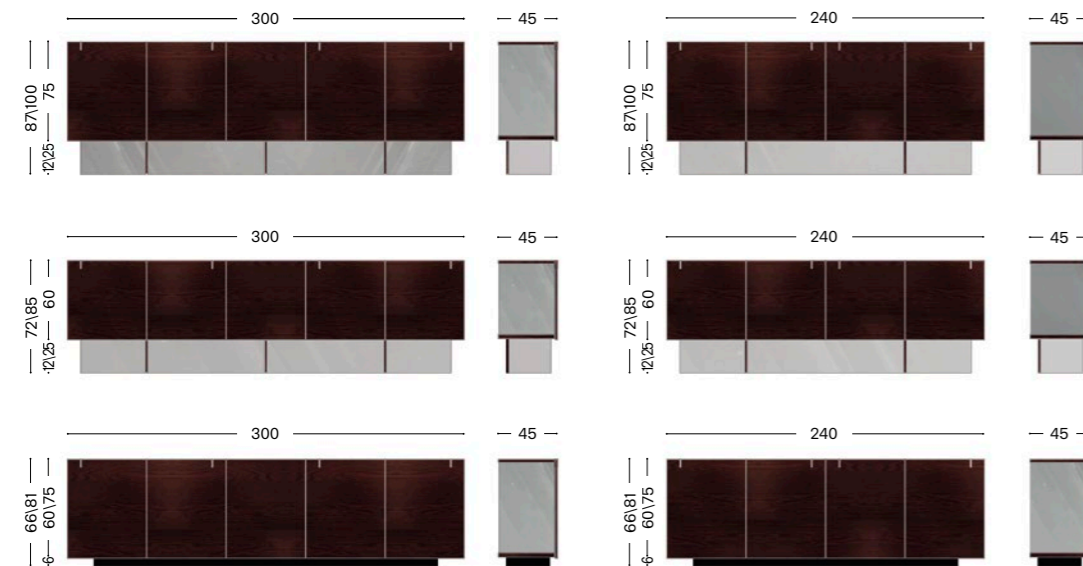

Struttura vetro  
Glass structure



FUMÉ  
SMOKED



BRONZO  
BRONZE

Ante, top e fondo legno  
Wood doors, top and bottom

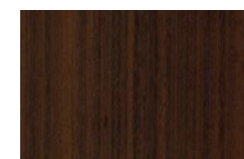

EUCALIPTO



SIBERIAN ASH

Maniglia  
Handle

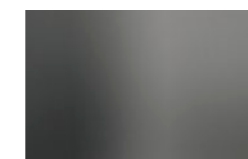

CANNA DI FUCILE LUCIDO  
POLISHED GUNMETAL

Basamento vetro  
Glass base



FUMÉ  
SMOKED



BRONZO  
BRONZE



EXTRACHIARO  
EXTRA CLEAR

Zoccolo e divisorio interno legno  
Wood plinth and internal dividing elements



NERO OPACO  
MATT BLACK

# Marcell console / desk / dressing table

Modularità  
Modularity



Struttura vetro  
Glass structure



FUMÉ  
SMOKED



EXTRACHIARO  
EXTRA CLEAR

Contenitori legno  
Wood storage

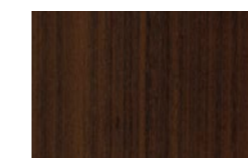

EUCALIPTO



SIBERIAN ASH



ROVERE NATURALE  
NATURAL OAK

# Whirl mirror

Modularità  
Modularity

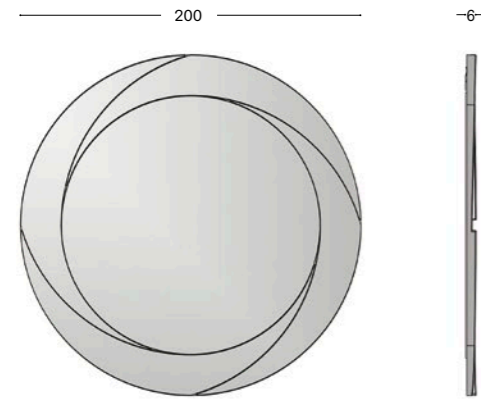

Specchio  
Mirror



FUMÉ  
SMOKED

BRONZO  
BRONZE

ORO  
GOLD

SPECCHIO  
MIRROR

# Crossover dining table

Modularità  
Modularity

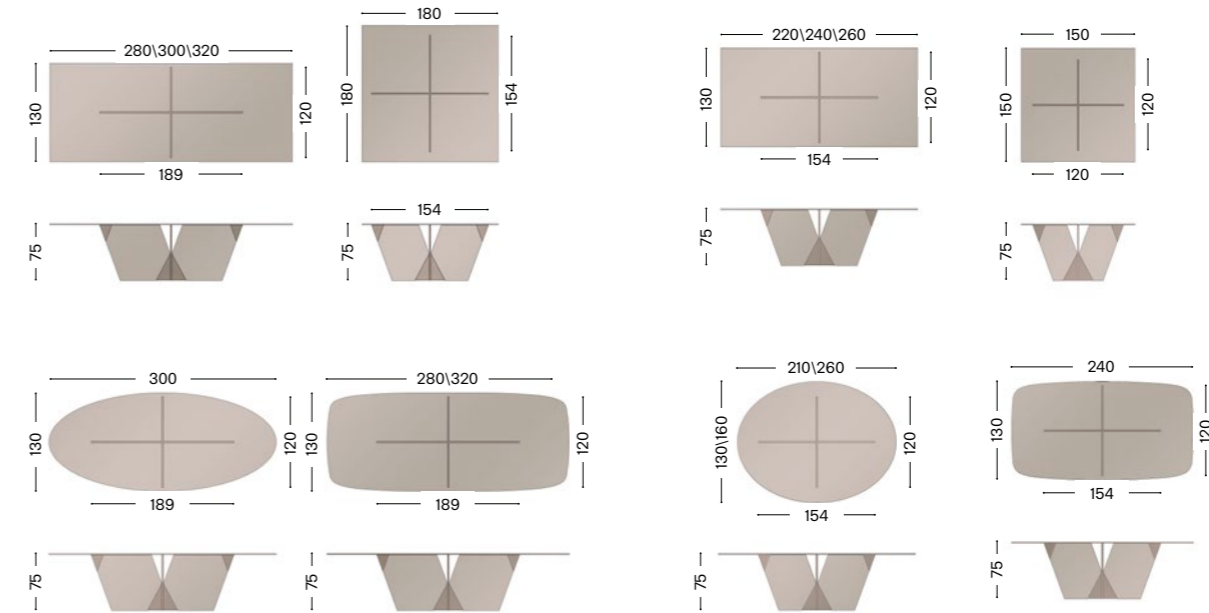

Struttura vetro  
Glass structure



FUMÉ  
SMOKED

BRONZO  
BRONZE

EXTRACHIARO  
EXTRA CLEAR

Basamento vetro  
Glass base



FUMÉ  
SMOKED

BRONZO  
BRONZE

EXTRACHIARO  
EXTRA CLEAR

Giunto e supporti metallo  
Metal joints and supports



CANNA DI FUCILE LUCIDO  
POLISHED GUNMETAL

TITANIO SPAZZOLATO OPACO  
MATT BRUSHED TITANIO

# Perseo dining table

Modularità  
Modularity

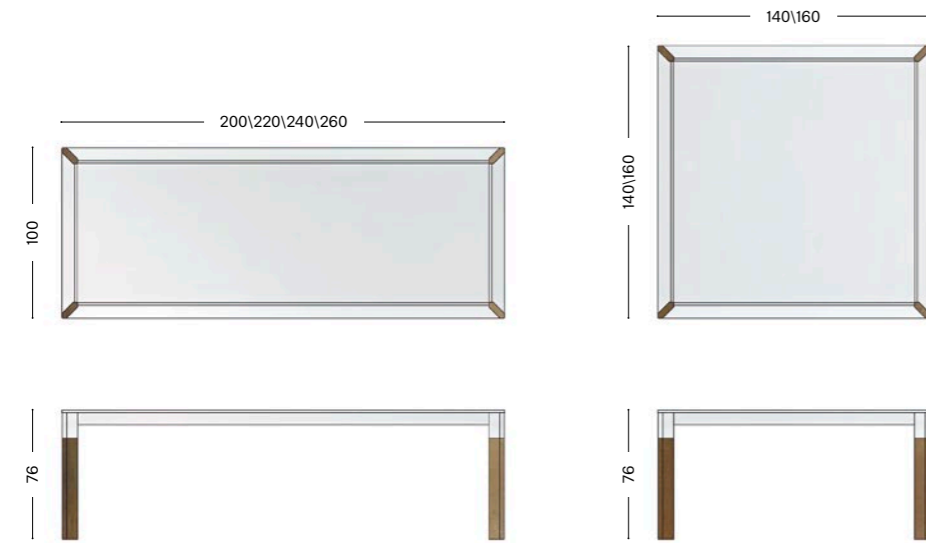

Top vetro  
Glass top



EXTRACHIARO  
EXTRA CLEAR

Gambe  
Legs



ANTRACITE SPAZZOLATO  
OPACO  
ANTRACITE MATT  
BRUSHED

OTTONE SPAZZOLATO  
OPACO  
OTTONE MATT  
BRUSHED

# Hyperion lamp

Modularità  
Modularity

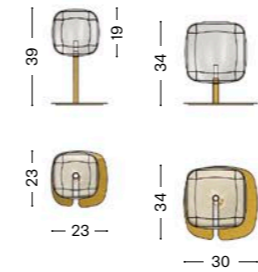

Struttura in metallo  
Metal structure



CROMO LUCIDO  
POLISHED CHROME



ORO LUCIDO  
POLISHED GOLD

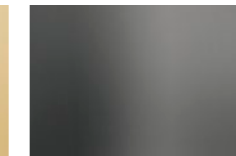

CANNA DI FUCILE LUCIDO  
POLISHED GUNMETAL

Vetro lampada  
Lamp glass



PYREX SOFFIATO  
TRASPARENTE  
TRANSPARENT BLOWN  
PYREX

# Maybe mirror

Modularità  
Modularity

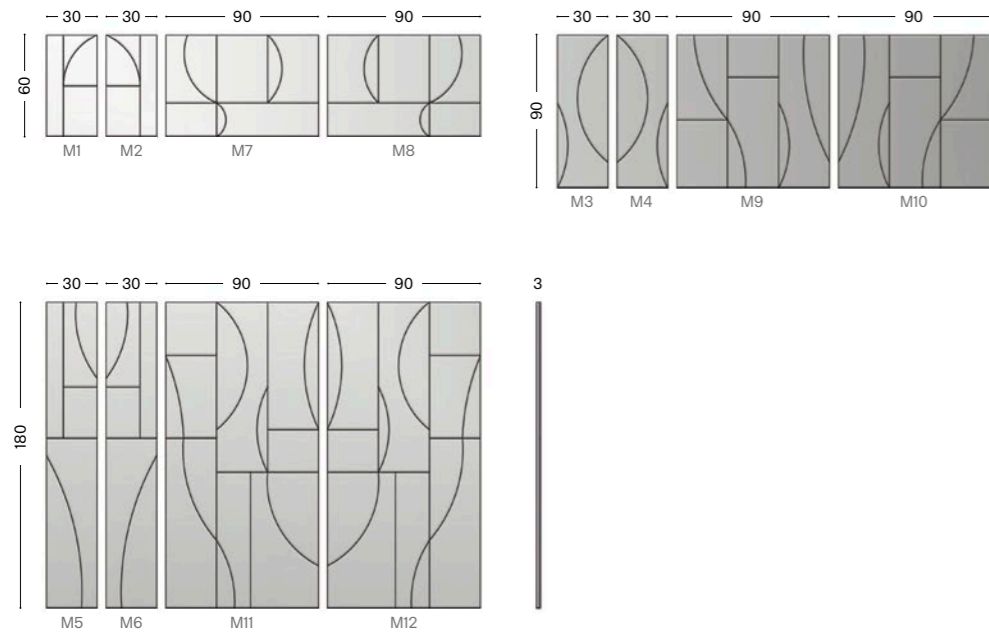

Specchio  
Mirror

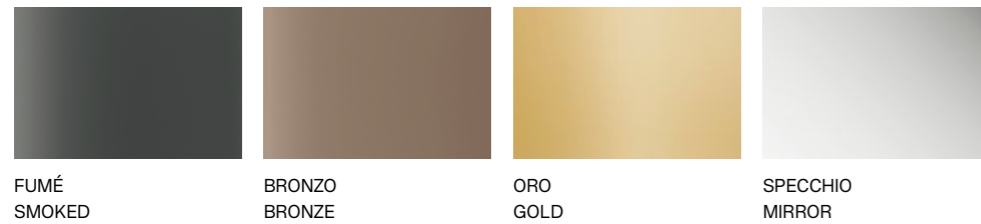

# She chair

Modularità  
Modularity

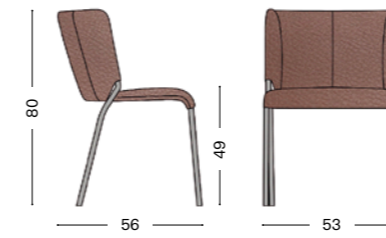

Struttura metallo  
Metal structure





Finiture pelle ed ecopelle vedi pag. 110/111  
Leather and faux leather finishes see pages 110/111

# Tonellidesign

## **Tonelli Design**

T.D. Srl  
via Casali 40/42  
61122 - Pesaro (PU) Italy  
tel. +39 0721 481172  
www.tonellidesign.it  
info@tonellidesign.it  
export@tonellidesign.it

-  Tonelli design
-  Tonelli\_Design
-  tonelli-design

## **The New Modernism**

### **art direction**

Massimo Castagna / AD Architettura

### **digital images**

Garage121

### **graphic design**

Enrico Severi Design

### **post production**

MIC Studio

### **print**

Grapho5

Published October 2021  
Tonelli Design / All rights reserved

# Tonellidesign

## **Tonelli Design**

T.D. Srl

via Casali 40/42

61122 - Pesaro (PU) Italy

tel. +39 0721 481172

[www.tonellidesign.it](http://www.tonellidesign.it)

[info@tonellidesign.it](mailto:info@tonellidesign.it)

[export@tonellidesign.it](mailto:export@tonellidesign.it)

 Tonelli design

 Tonelli\_Design

 tonelli-design